

### Renvooi

-  - entree woongebouw
-  - erfgrans
-  - parkeervak eigen terrein
-  - parkeervak openbaar
-  - houten vlonder
-  - pergola
-  - haag laag
-  - haag hoog
-  - water
-  - openbaar groen
-  - wandelpad houtsnippers
-  - voetpad
-  - inrit
-  - straat
-  - talud
-  - boom, positie in overleg met koper
-  - indicatie positie riolering
-  - zone erfdienstbaarheid
-  - klinkerbestrating

### parkeerplekken en posities bomen indicatief

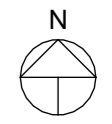

Tekening: **Situatie totaal**

---

Woningtype: **E60,E60D,F60,F60+**

---

Bouwnummer: **1 t/m 31**

---

Bladnummer: **VT-S-00**

---

Bladformaat: **A3**

---

Schaal: **1:750**

---

Datum: **21-04-2026**

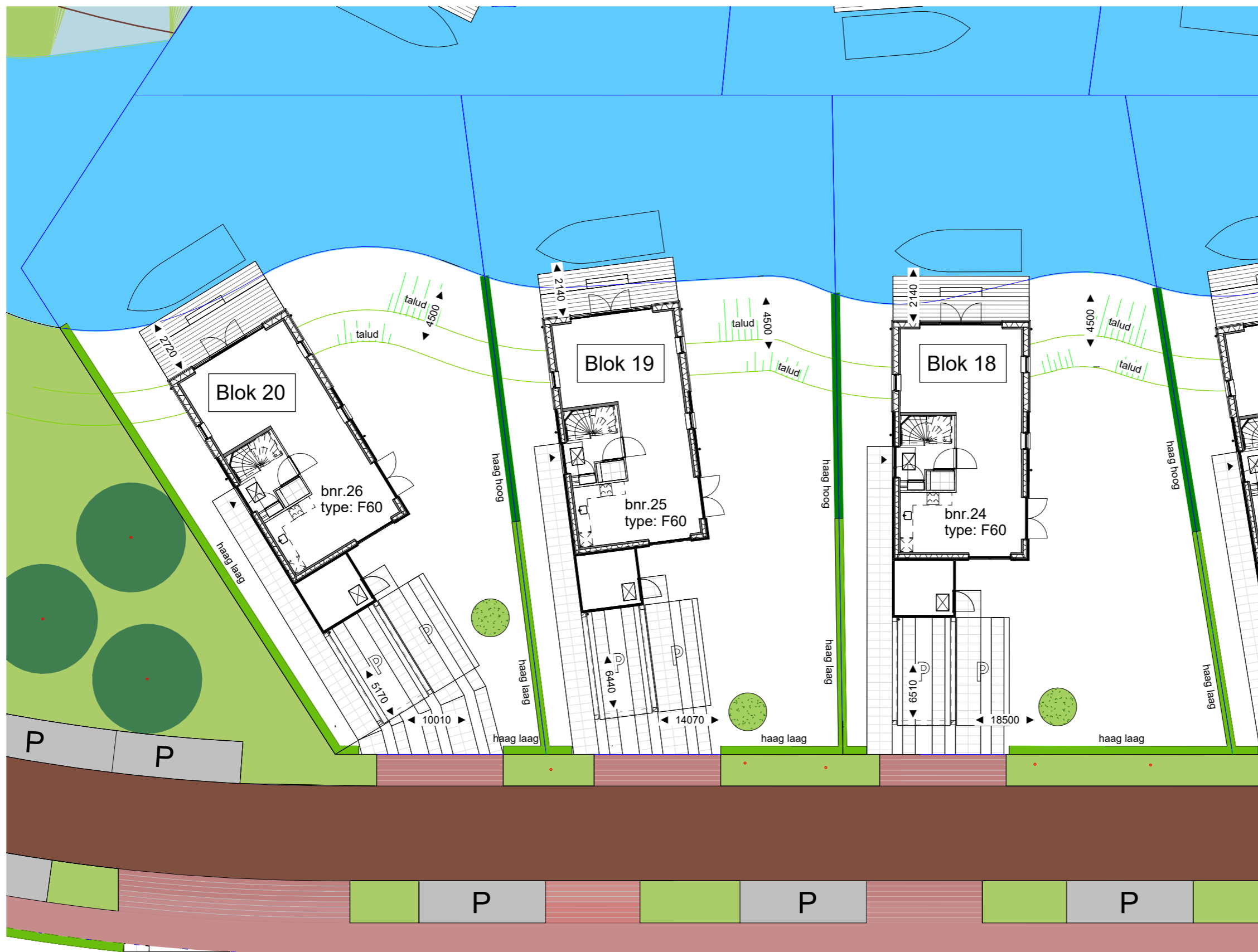

### Renvooi

- entree woongebouw
- erfgrans
- parkeervak eigen terrein
- parkeervak openbaar
- houten vlonder
- pergola
- haag laag
- haag hoog
- water
- openbaar groen
- wandelpad houtsnippers
- voetpad
- inrit
- straat
- talud
- boom, positie in overleg met koper
- indicatie positie riolering
- zone erfdienstbaarheid
- klinkerbestrating

### parkeerplekken en posities bomen indicatief



Tekening: **Situatie bnr.24-26**

Woningtype: **F60**

Bouwnummer: **24, 25, 26**

Bladnummer: **VT-S-08**

Bladformaat: **A3**











Schaal: **1:200**

Datum: **21-04-2026**

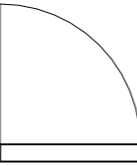
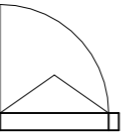
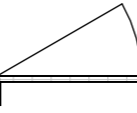
## Renvooi materialen

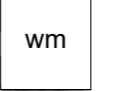
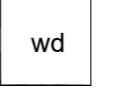
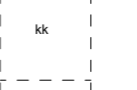
	dakpan antracietgrijs
	metselwerk kleur grijswit gesinterd code A: EN1166 WF WS
	metselwerk kleur bruin nuance code B: HM1106 WF WS
	metselwerk kleur bruin caramel code C: EN1165 WF WS
	gevelbetimmering vuren vergrijsd

## Renvooi bouwkundig

	entree woning
	metselwerk
	isolatie
	dragende wand
	niet dragende binnenwand
	buitendeur
	draairaam
	binnendeurkozijn (met bovenlicht)
	kruipluik
	opstelplaats wasmachine
	opstelplaats wasdroger
	opstelplaats koelkast
	principe opstelling keukenblok
	onbenoemde ruimte volgens krijtstreepmethode
	

## Renvooi installaties

	aansluitpunt licht, wand
	centraaldoos met lichtpunt
	armatuur aan de wand
	rookmelder
	aansluitpunt niet bedraad / loos
	aansluitpunt bedraad data, niet afgemonteerd
	beldrukker
	schel
	schakelaar, 1-polig
	werkschakelaar tbv PV-panelen
	driestandenschakelaar tbv wtw
	schakelaar, wissel
	schakelaar, serie
	pulsschakelaar tbv warmteterugwinunit
	wandcontactdoos 1-voudig met beschermingscontact
	wandcontactdoos 2-voudig met beschermingscontact
	thermostaatleiding, bedraad
	wandcontactdoos tbv warmteterugwinunit
	wtw mechanische ventilatie-unit incl. warmteterugwinunit
	wp warmtepomp
	inblaasventiel mechanische ventilatie
	afzuigventiel mechanische ventilatie
	vv verdeler vloerverwarming
	ruimte vzv vloerverwarming
	rad elektrische radiator
	kanalen in het zicht
	doucheput
	lijngoot douche
	buitenkraan

### Disclaimer

De op deze tekeningen aangegeven maten zijn circa maten in millimeters en tussen de wanden / vloeren gemeten, waarbij geen rekening is gehouden met enige wandafwerking, plinten, aftimmering, etc. In verband met de nauwkeurige uitwerking van details, constructie, maatvoering, materialen e.d. kunnen er kleine afwijkingen ontstaan ten opzichte van de nu vermelde gegevens. Deze geringe afwijkingen geven geen aanleiding tot verrekening. Aan de op deze tekening aangegeven maten kunnen derhalve geen rechten worden ontleend. De op deze tekeningen aangegeven maatvoering is niet geschikt voor opdrachten aan derden door koper(s). De posities van aansluitingen en installatie onderdelen zijn indicatief op tekening aangegeven. De exacte aantallen en posities zullen na berekening in het werk door de installateurs worden bepaald en kunnen afwijken van deze tekening.



Tekening:	Renvooi
Woningtype:	E60 / F60 / F60+
Bouwnummer:	1 t/m 31
Bladnummer:	VT-0-00c
Bladformaat:	A3
Schaal:	1 : 50
Datum:	21-04-2026

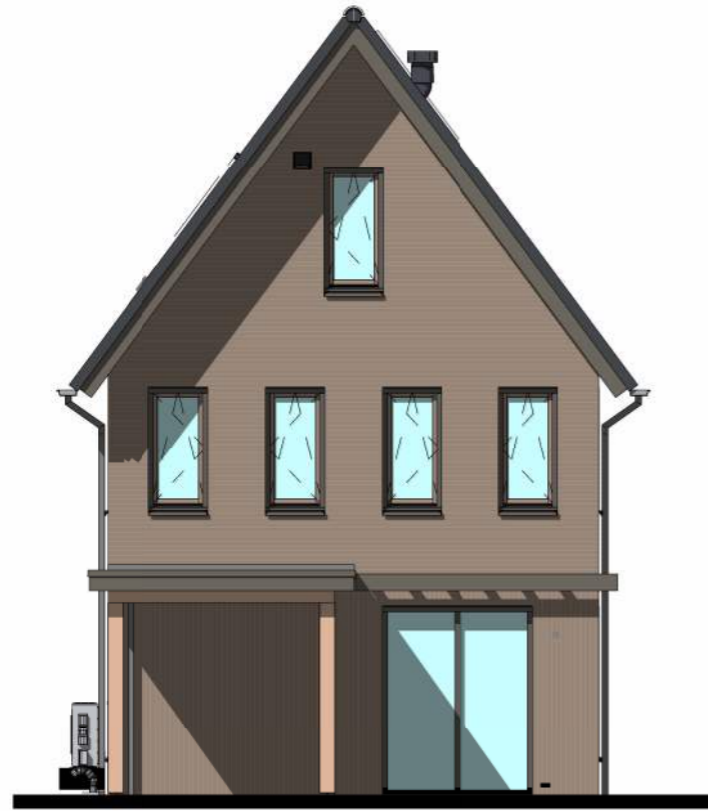

Voorgevel

Type: F60s  
bnr: 24

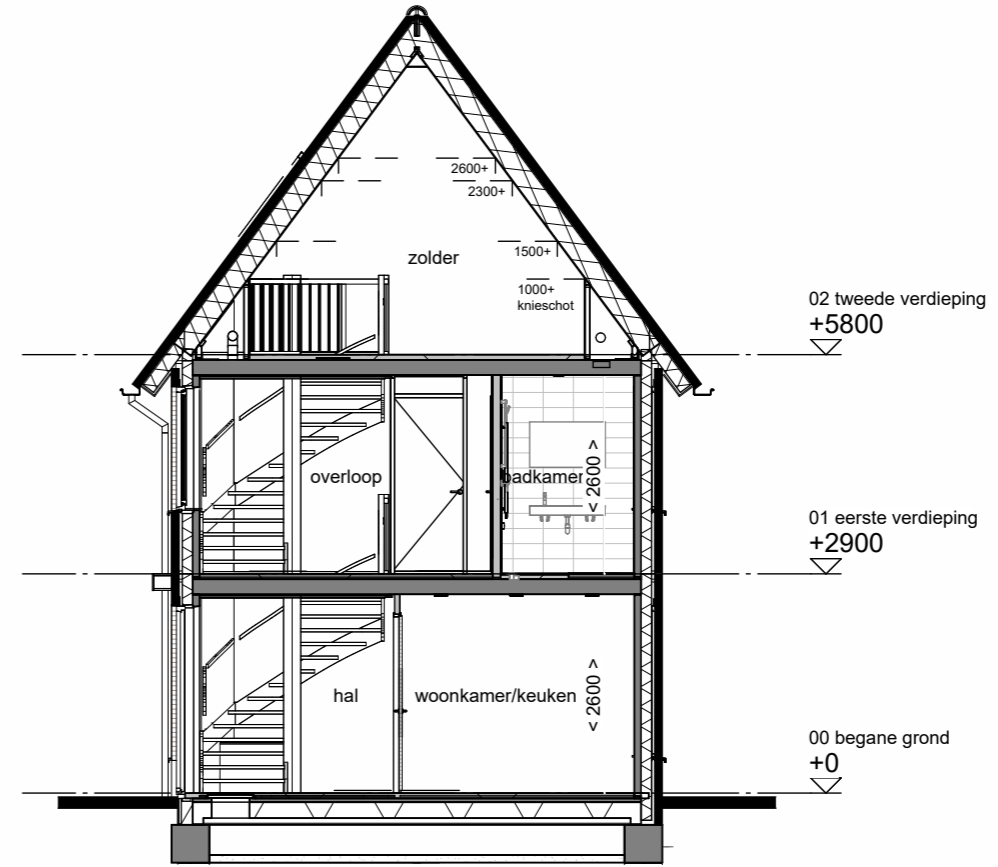

Doorsnede



Achtergevel

Type: F60s  
bnr: 24



Tekening: Gevel/Drsn Blok 18

Woningtype: F60s

Bouwnummer: 24

Bladnummer: VT-18-00a

Bladformaat: A3

Schaal: 1 : 100

Datum: 21-04-2026

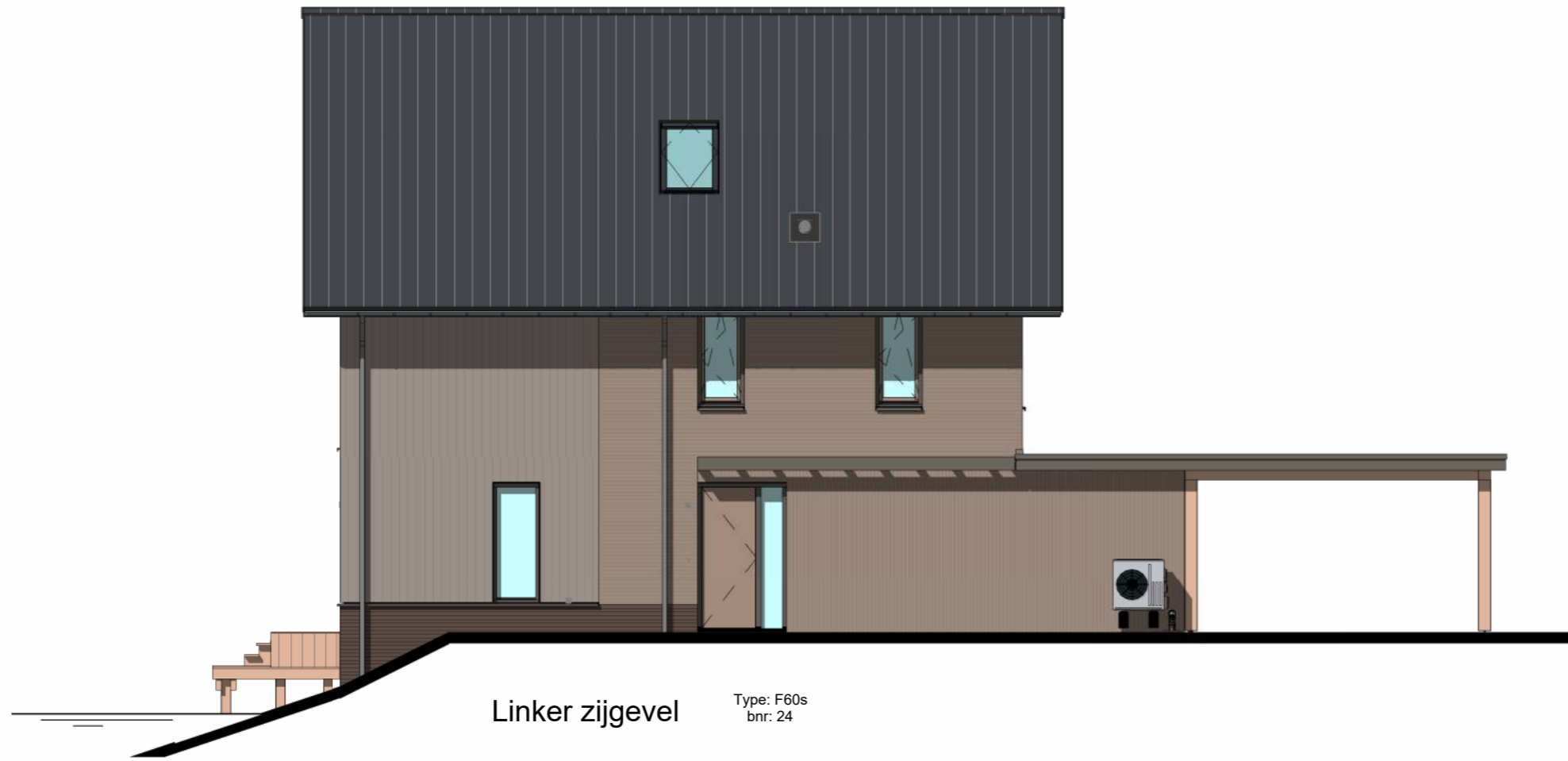

Linker zijgevel

Type: F60s  
bnr: 24



Rechter zijgevel

Type: F60s  
bnr: 24



**Wonen aan  
de Gantel**

Tekening: Zijgevels blok 18

Woningtype: F60s

Bouwnummer: 24

Bladnummer: VT-18-00b

Bladformaat: A3

Schaal: 1 : 100

Datum: 21-04-2026

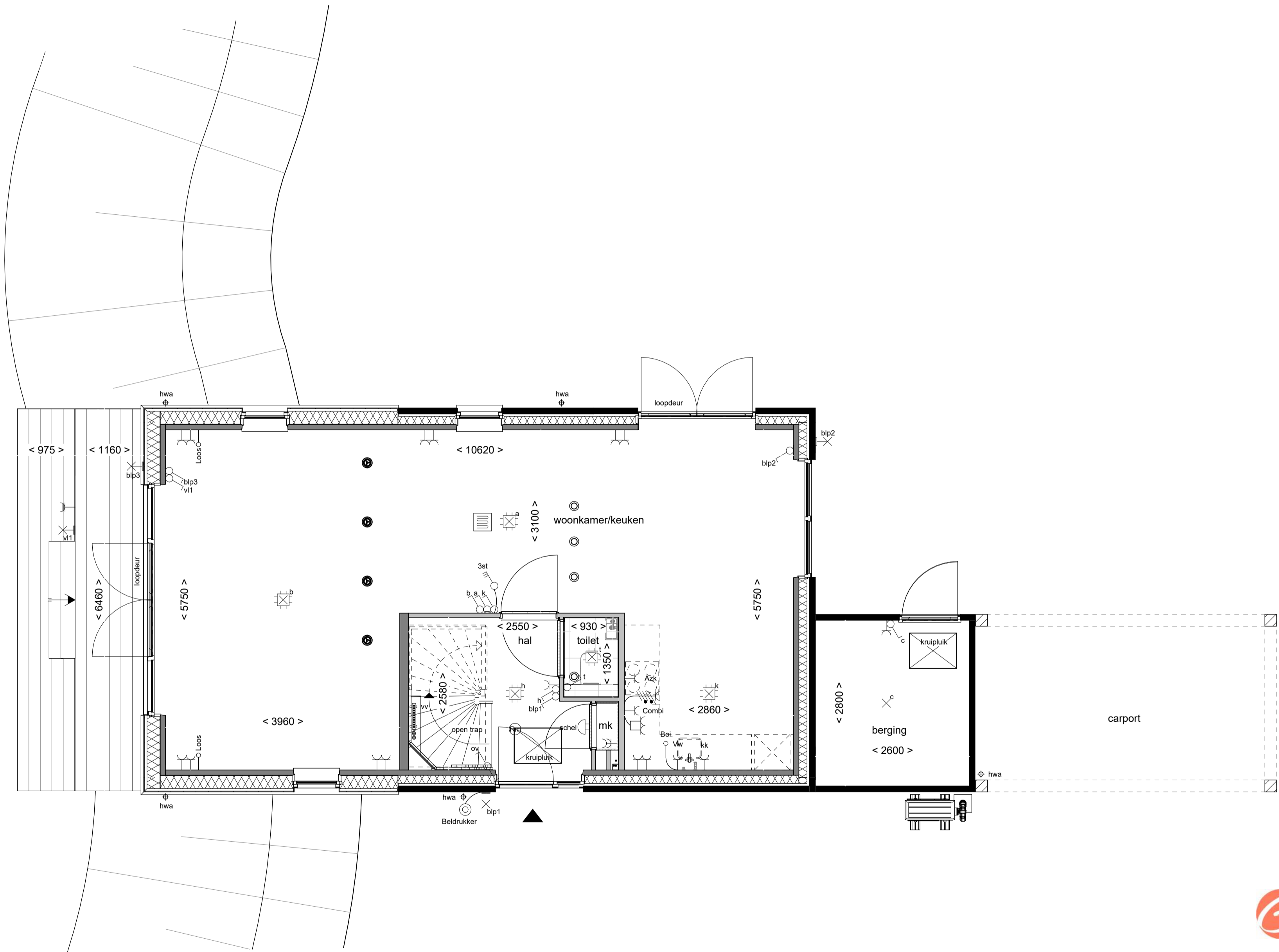

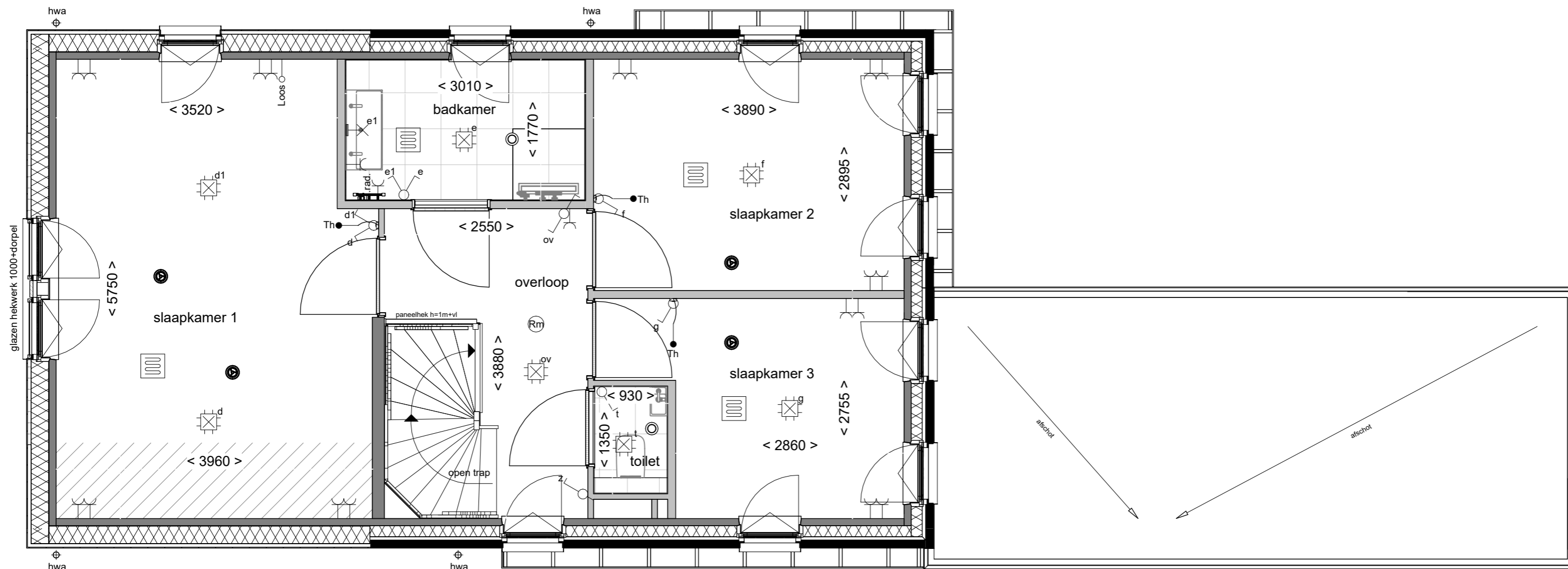

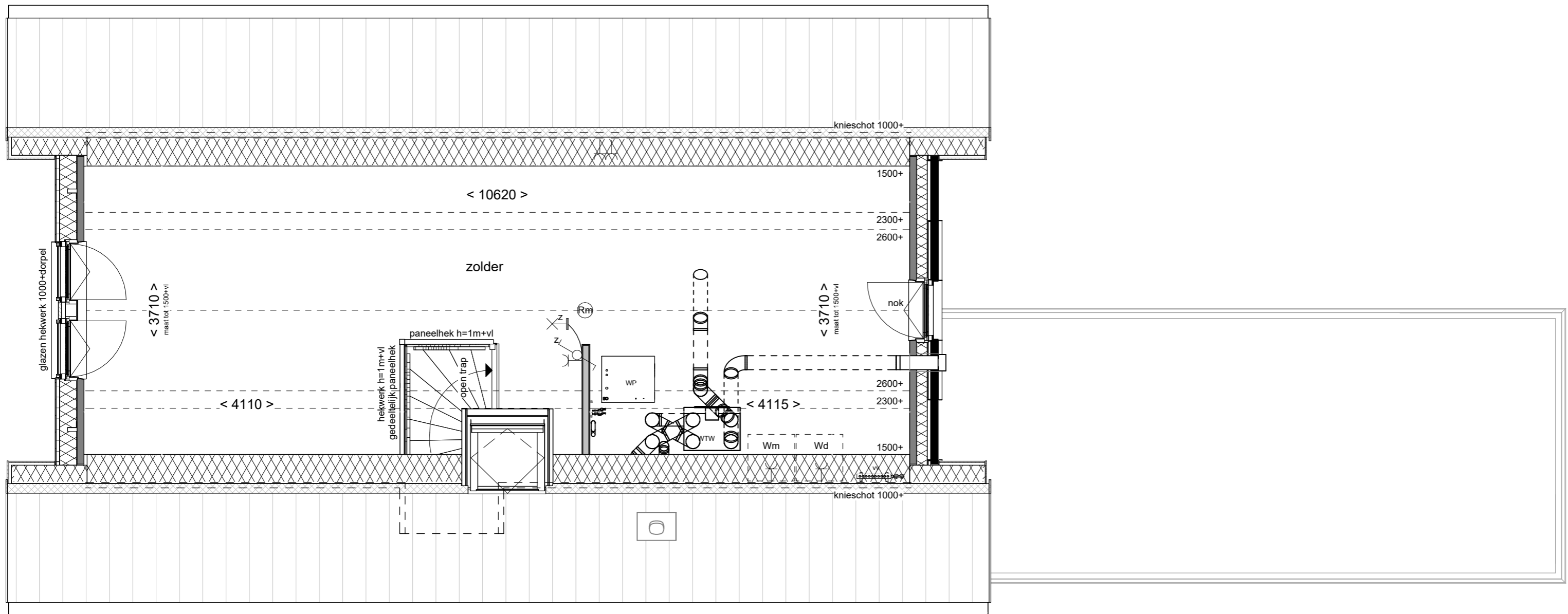

Tekening: Tweede verdieping

Woningtype: F60s

Bouwnummer: 24

Bladnummer: VT-18-24c

Bladformaat: A3

Schaal: 1 : 50

Datum: 21-04-2026

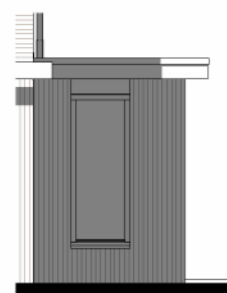
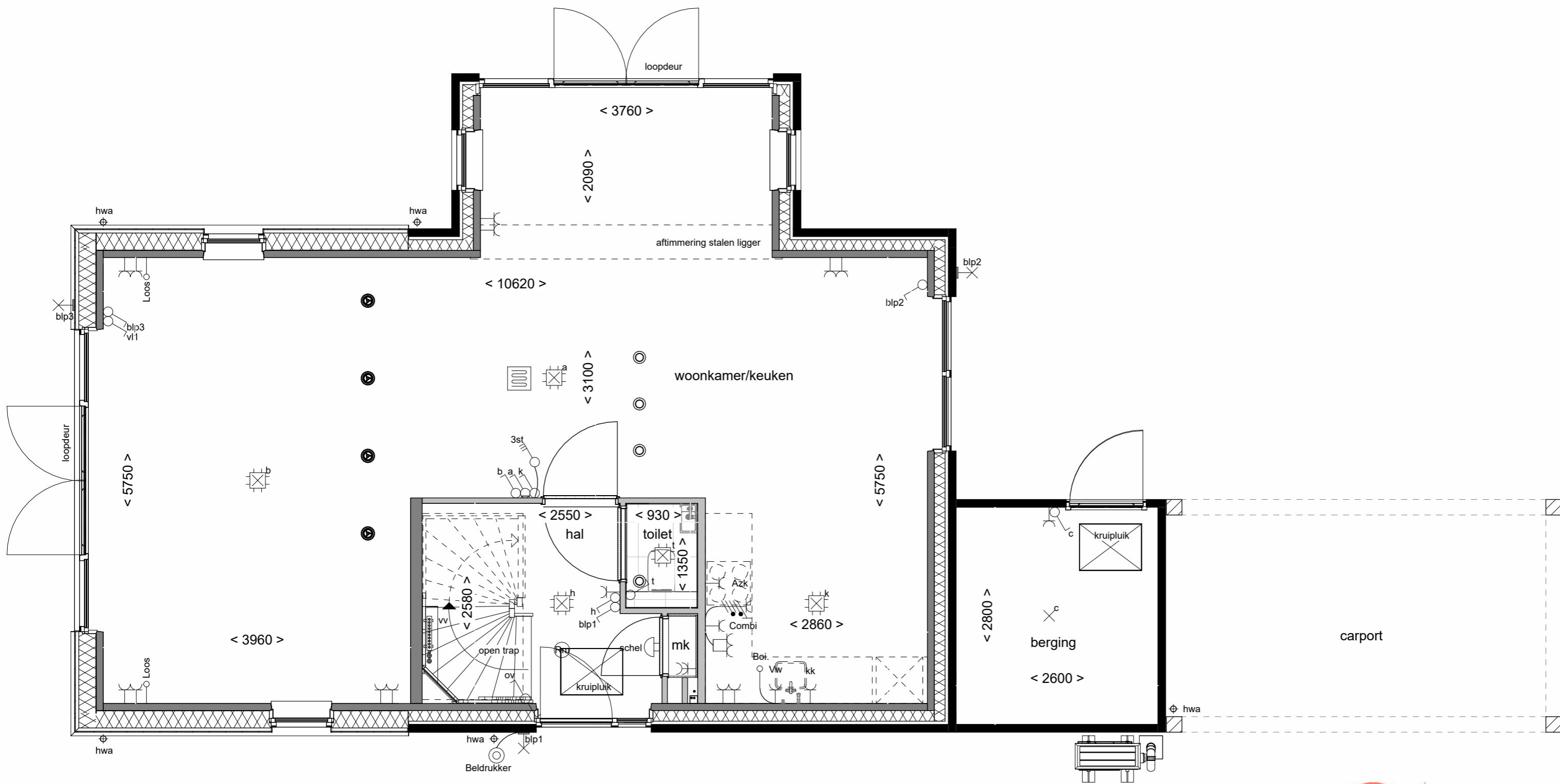

Vooraanzicht



Zijaanzicht schaal 1:100

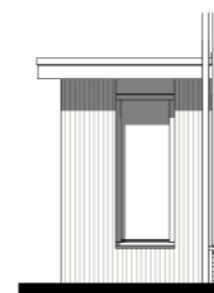

Achteraanzicht

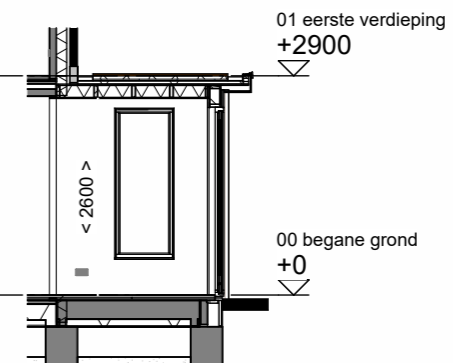

Doorsnede schaal 1:100



Tekening:	Erker
Woningtype:	F60-2
Bouwnummer:	21, 23 t/m 31
Optienummer:	1.A.X.48
Bladformaat:	A3
Schaal:	1:50 / 1:100
Datum:	21-04-2026

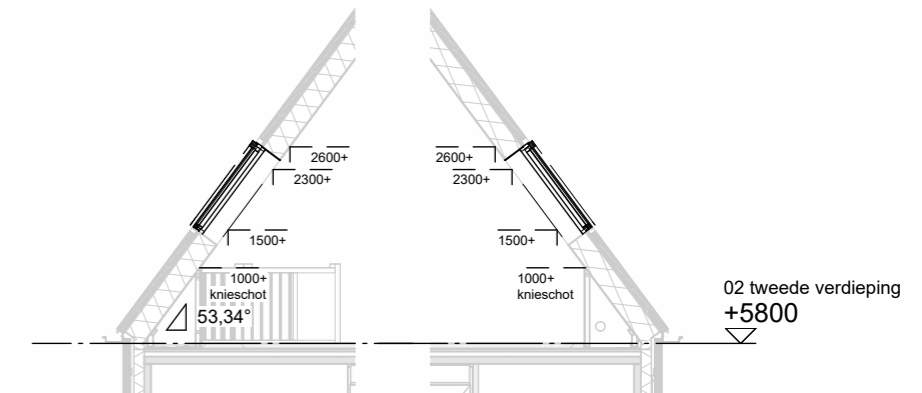
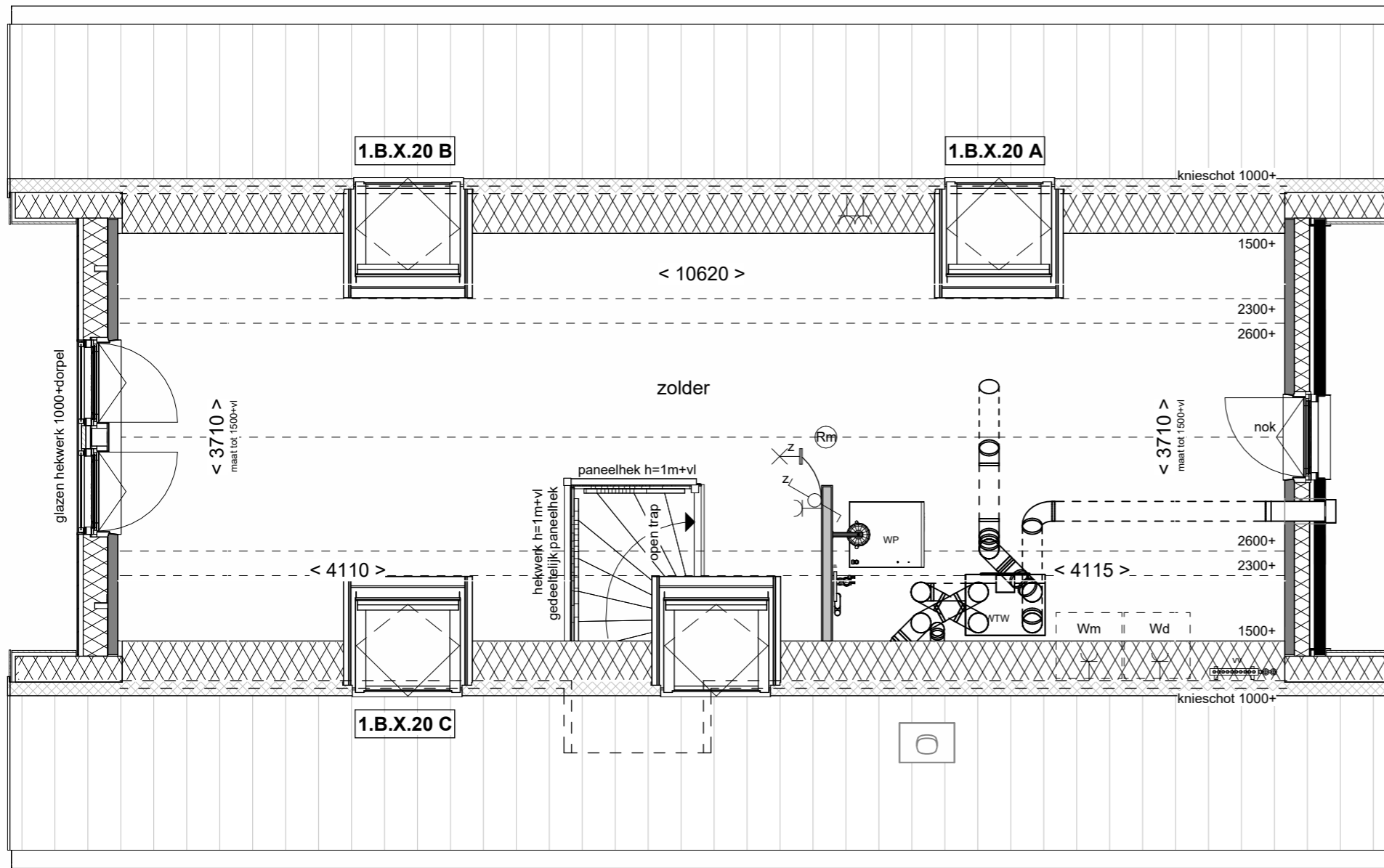

Doorsnedes schaal 1:100

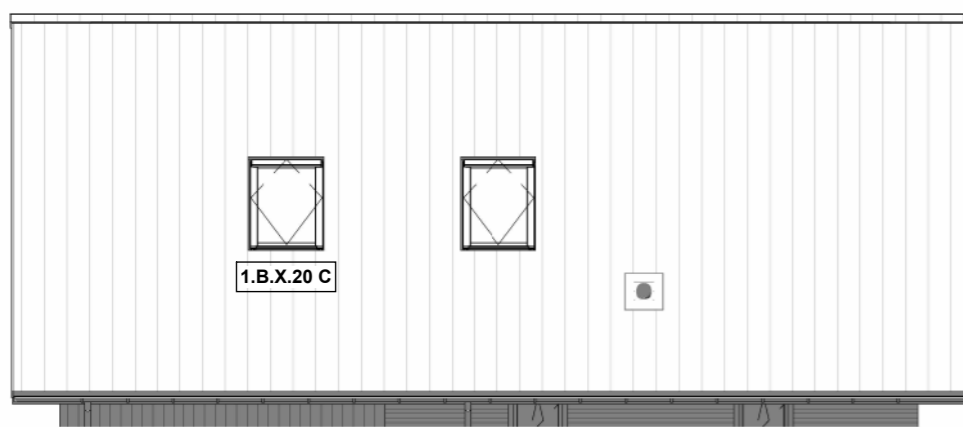

Linker zijaanzicht schaal 1:100

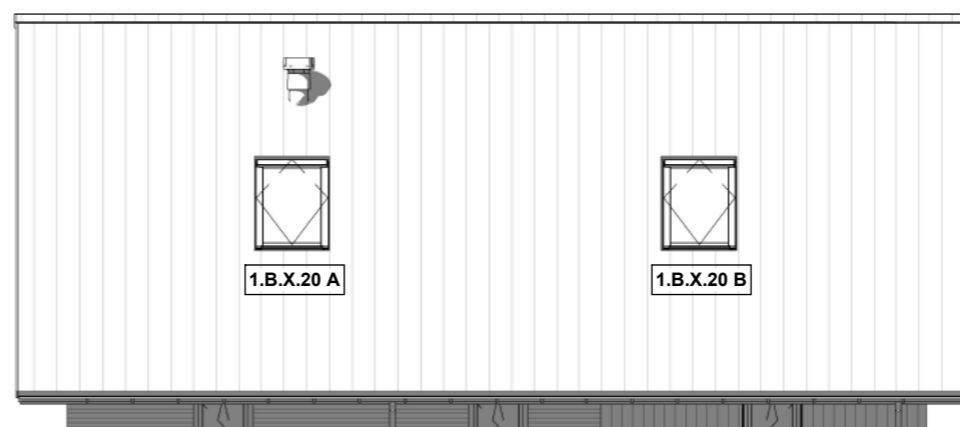

Rechter zijaanzicht schaal 1:100



Tekening: Dakramen zijgevel  
 Woningtype: F60-2  
 Bouwnummer: 21 t/m 31  
 Optienummer: 1.B.X.20  
 Bladformaat: A3  
 Schaal: 1:50 / 1:100  
 Datum: 21-04-2026

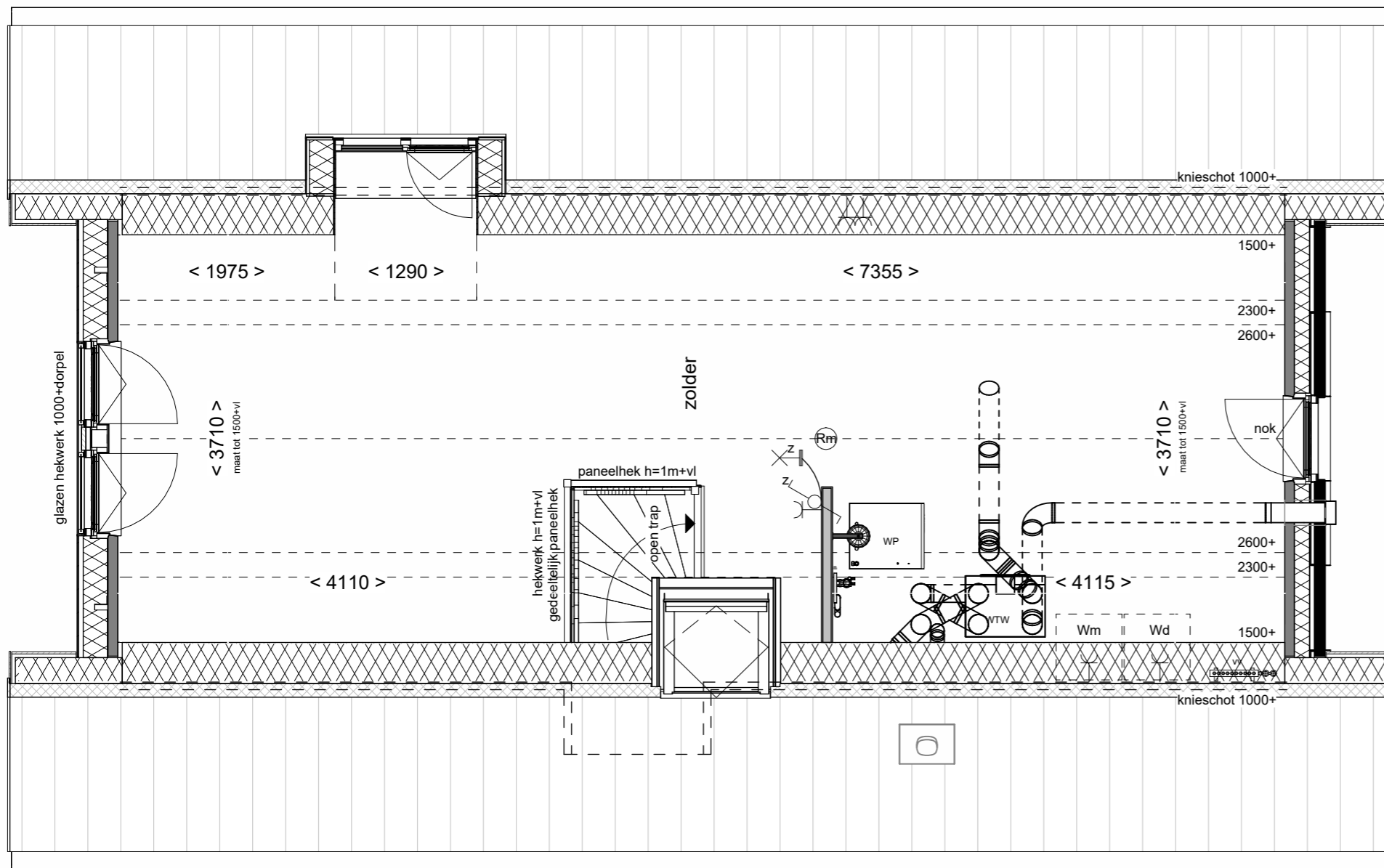

Rechter zijaanzicht schaal 1:100

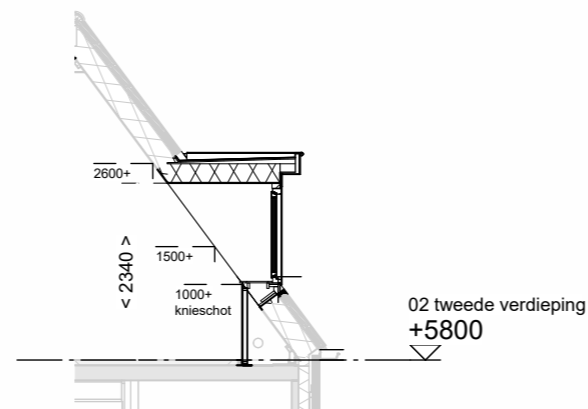

Doorsnede schaal 1:100



Dakkapel  
zijgevel 130cm

Tekening:

Woningtype: F60-2

Bouwnummer: 22 t/m 30

Optienummer: 1.B.X.36

Bladformaat: A3

Schaal: 1:50 / 1:100

Datum: 21-04-2026

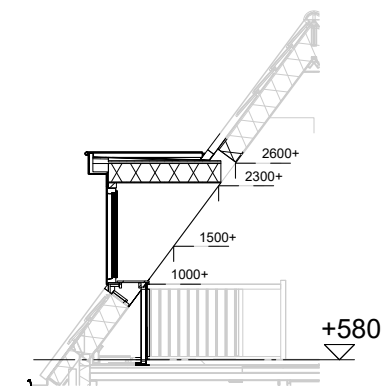
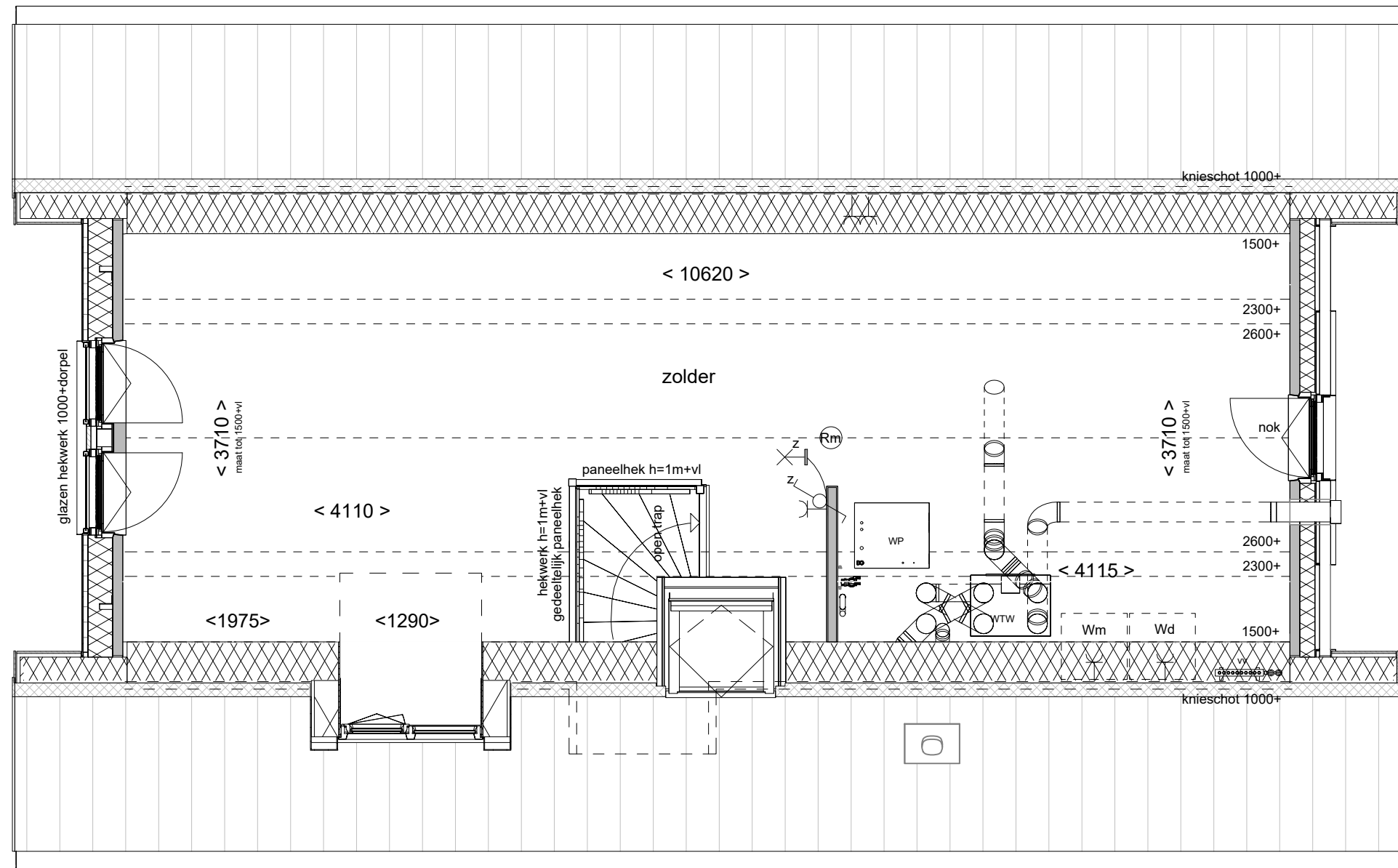

Doorsnede schaal 1:100



Dakkapel zijgevel  
130cm

Tekening: 130cm

Woningtype: F60-2

Bouwnummer: 21-25 en 28-31

Optienummer: 1.B.X.36

Bladformaat: A3

Schaal: 1:50 / 1:100

Datum: 21-04-2026

02 tweede verdieping

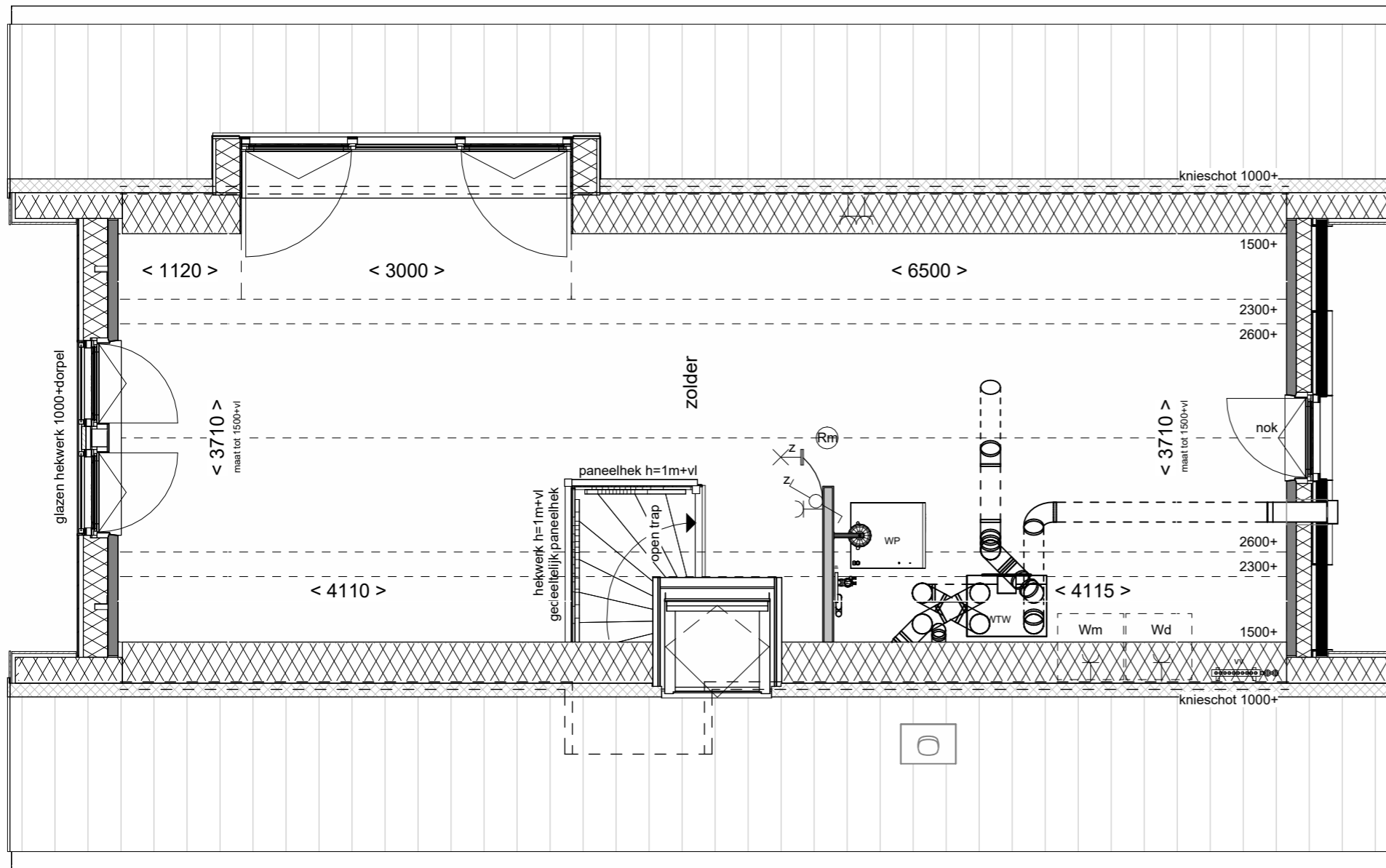

Rechter zijaanzicht schaal 1:100

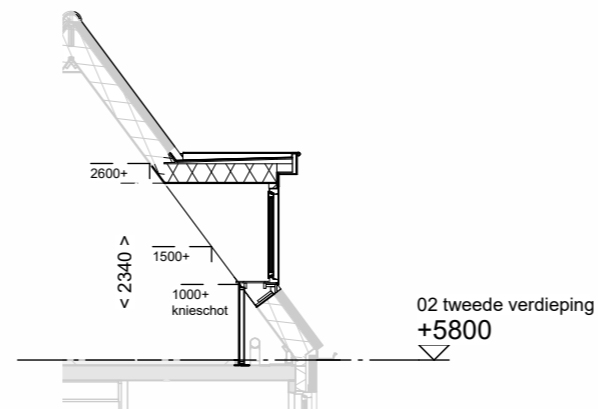

Doorsnede schaal 1:100



Dakkapel  
zijgevel 300cm

Tekening:

Woningtype: F60-2

Bouwnummer: 22 t/m 30

Optienummer: 1.B.X.38

Bladformaat: A3

Schaal: 1:50 / 1:100

Datum: 21-04-2026

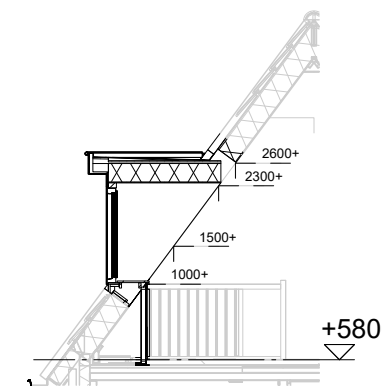
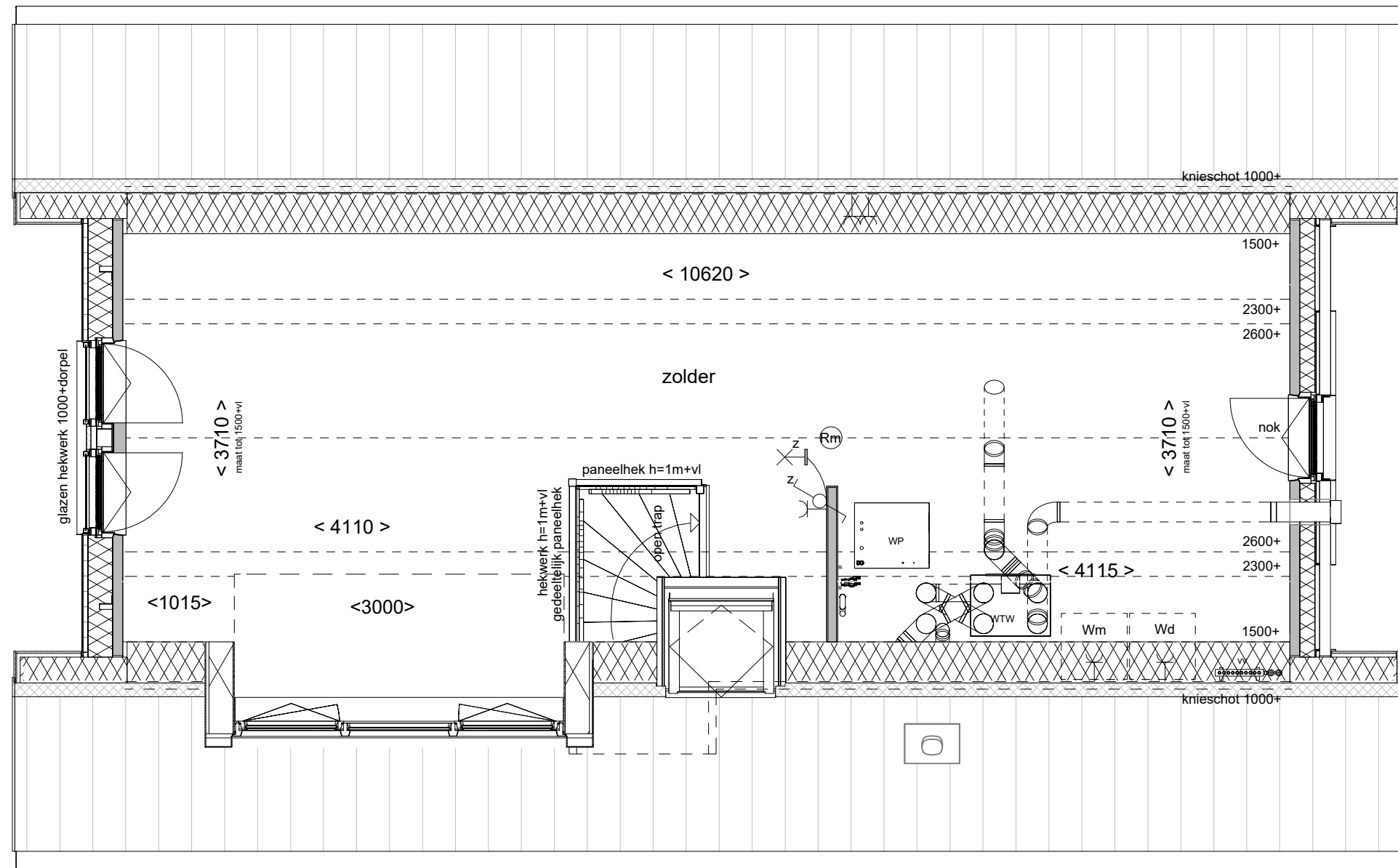

Doorsnede schaal 1:100



Dakkapel zijgevel  
300cm

Tekening:

Woningtype: F60-2

Bouwnummer: 21-25 en 28-31

Optienummer: 1.B.X.38

Bladformaat: A3

Schaal: 1:50 / 1:100

Datum: 21-04-2026

02 tweede verdieping

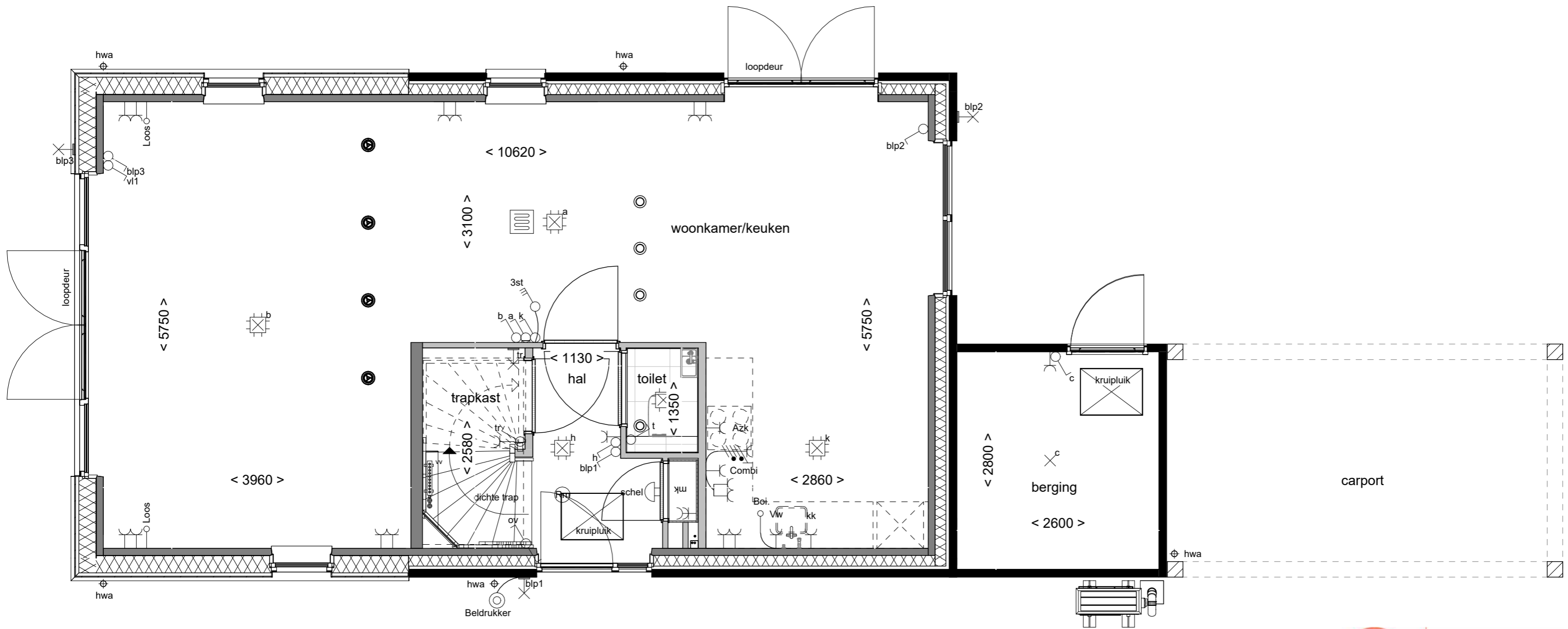

Tekening: Trapkast

Woningtype: F60-2

Bouwnummer: 21 t/m 31

Optienummer: 1.C.F.10

Bladformaat: A3

Schaal: 1 : 50

Datum: 21-04-2026

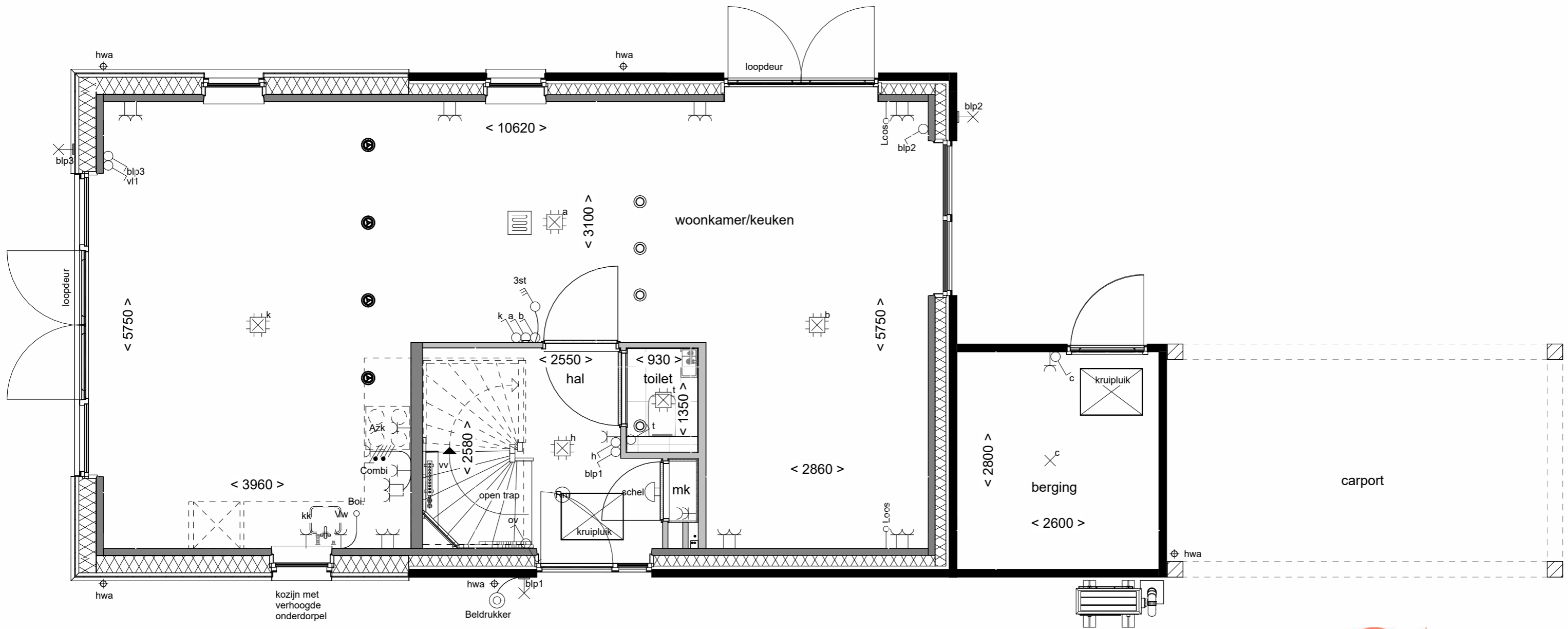

Tekening: Keuken achterzijde

Woningtype: F60-2

Bouwnummer: 21 t/m 31

Optienummer: 1.C.F2.12

Bladformaat: A3

Schaal: 1:50 / 1:100

Datum: 21-04-2026

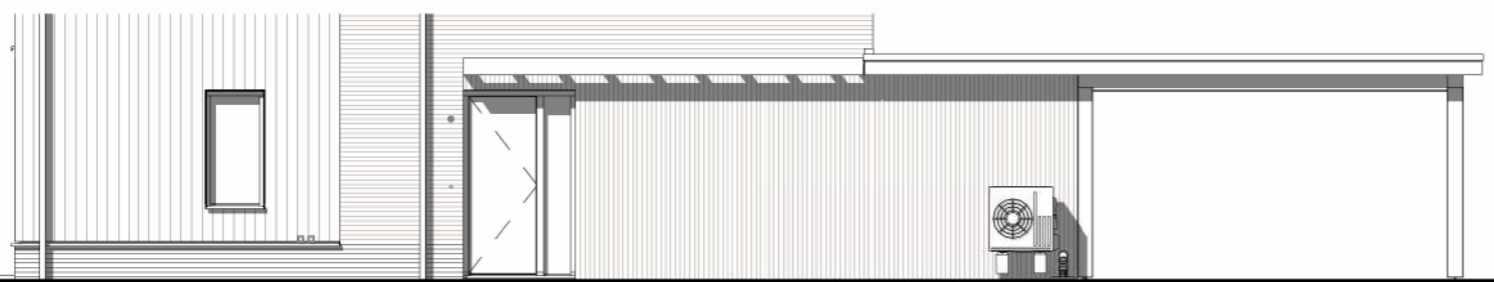

kozijn met verhoogde onderdorpel t.b.v. keuken

Zijaanzicht schaal 1:100

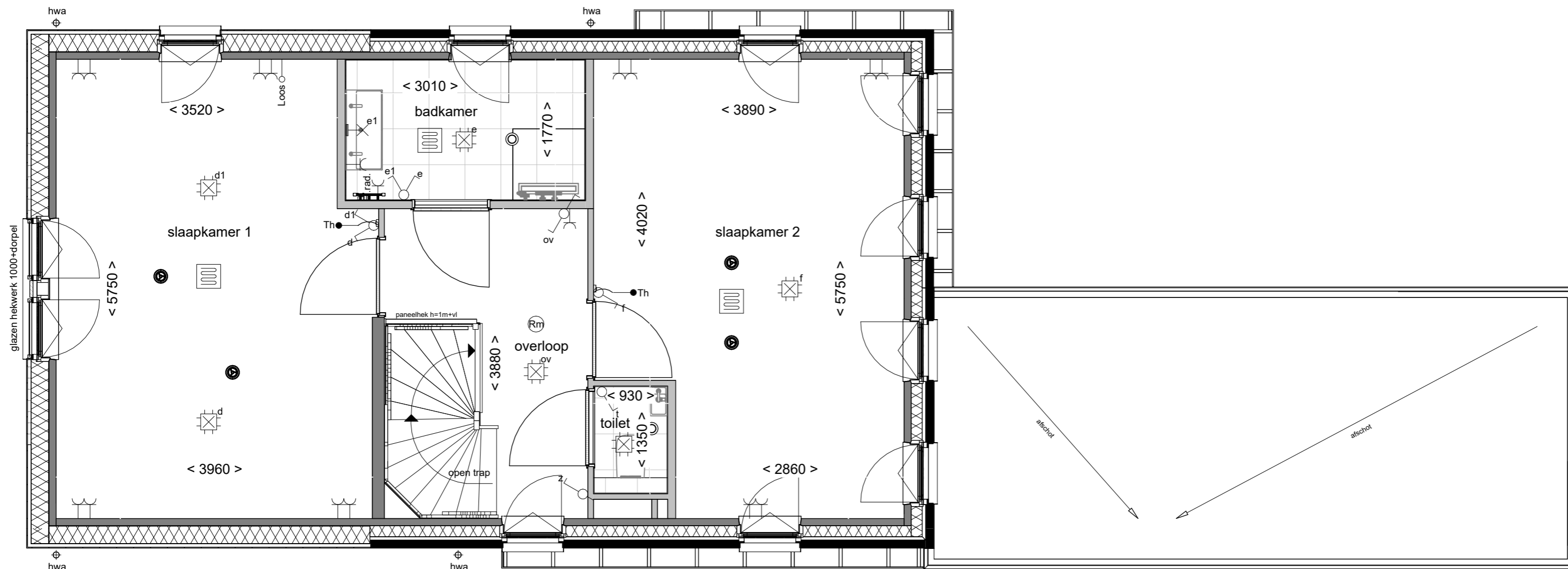

Samenvoegen  
slaapkamers voor

Tekening:

Woningtype: F60-2

Bouwnummer: 21 t/m 31

Optienummer: 1.C.F.30

Bladformaat: A3

Schaal: 1 : 50

Datum: 21-04-2026

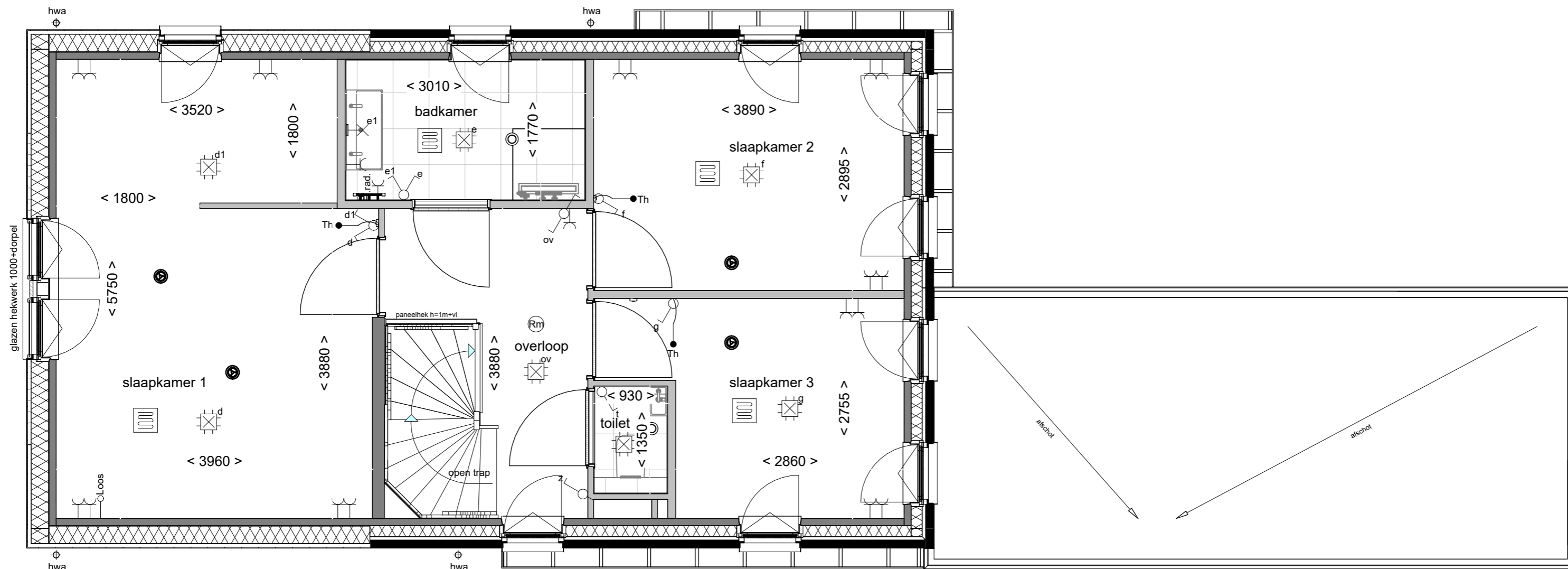

**Wonen aan  
de Gantel**

Samenvoegen slpk  
voor met inloopkast

Tekening:

Woningtype: F60-2

Bouwnummer: 21 t/m 31

Optienummer: 1.C.F.32

Bladformaat: A3

Schaal: 1 : 50

Datum: 21-04-2026

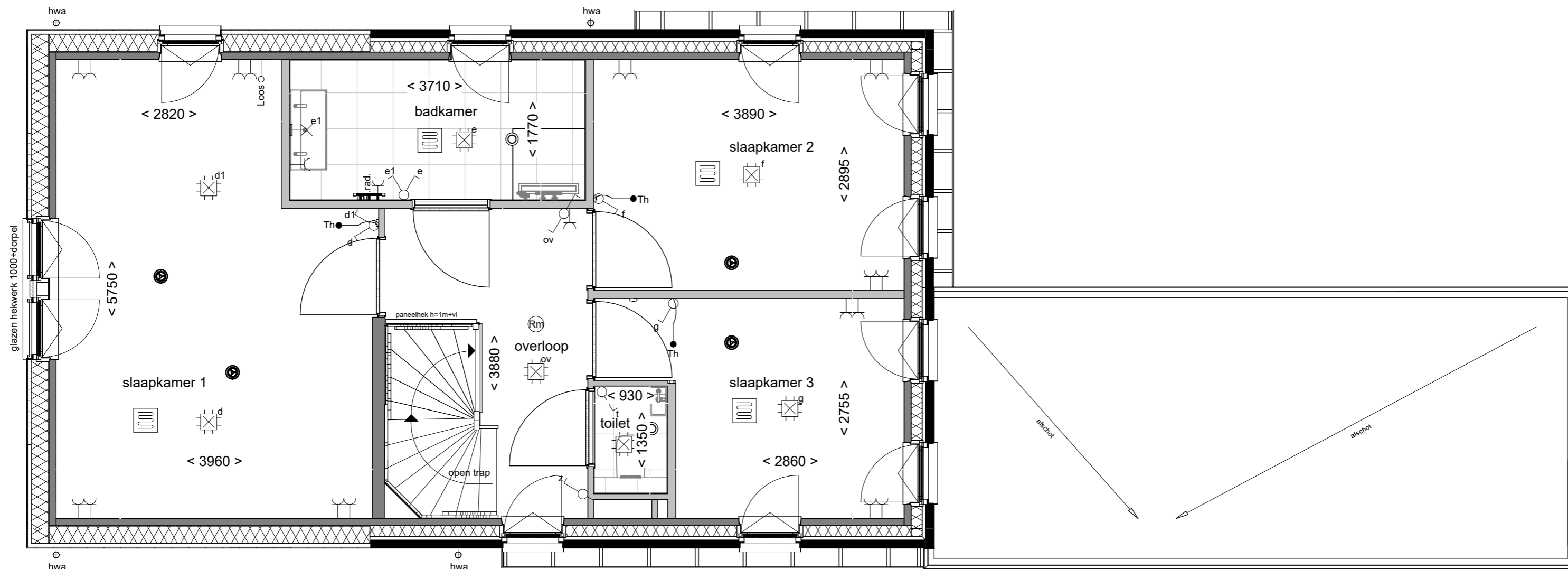

Tekening: **Badkamer vergroten**

Woningtype: **F60-2**

Bouwnummer: **21 t/m 31**

Optienummer: **1.C.F.42**

Bladformaat: **A3**

Schaal: **1 : 50**

Datum: **21-04-2026**

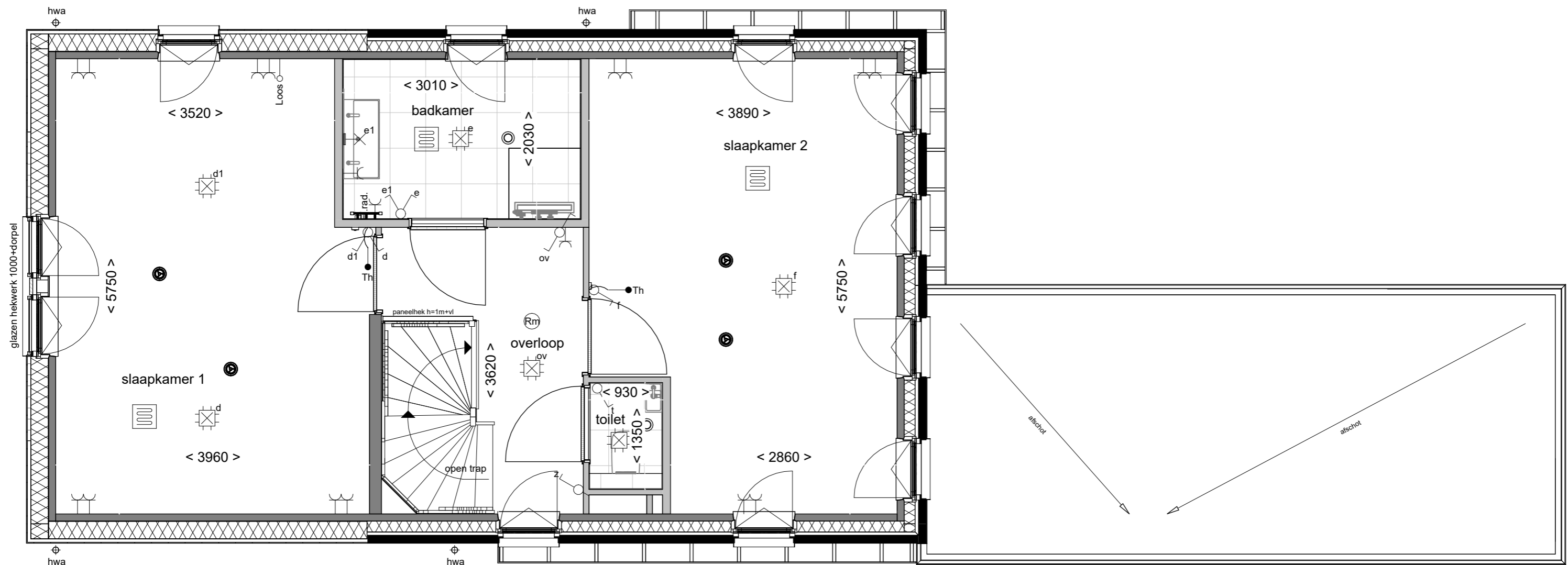

alleen i.c.m. optie 1.C.F.30



Tekening: **Badkamer verbreden**

Woningtype: **F60-2**

Bouwnummer: **21 t/m 31**

Optienummer: **1.C.F.44**

Bladformaat: **A3**

Schaal: **1 : 50**

Datum: **21-04-2026**

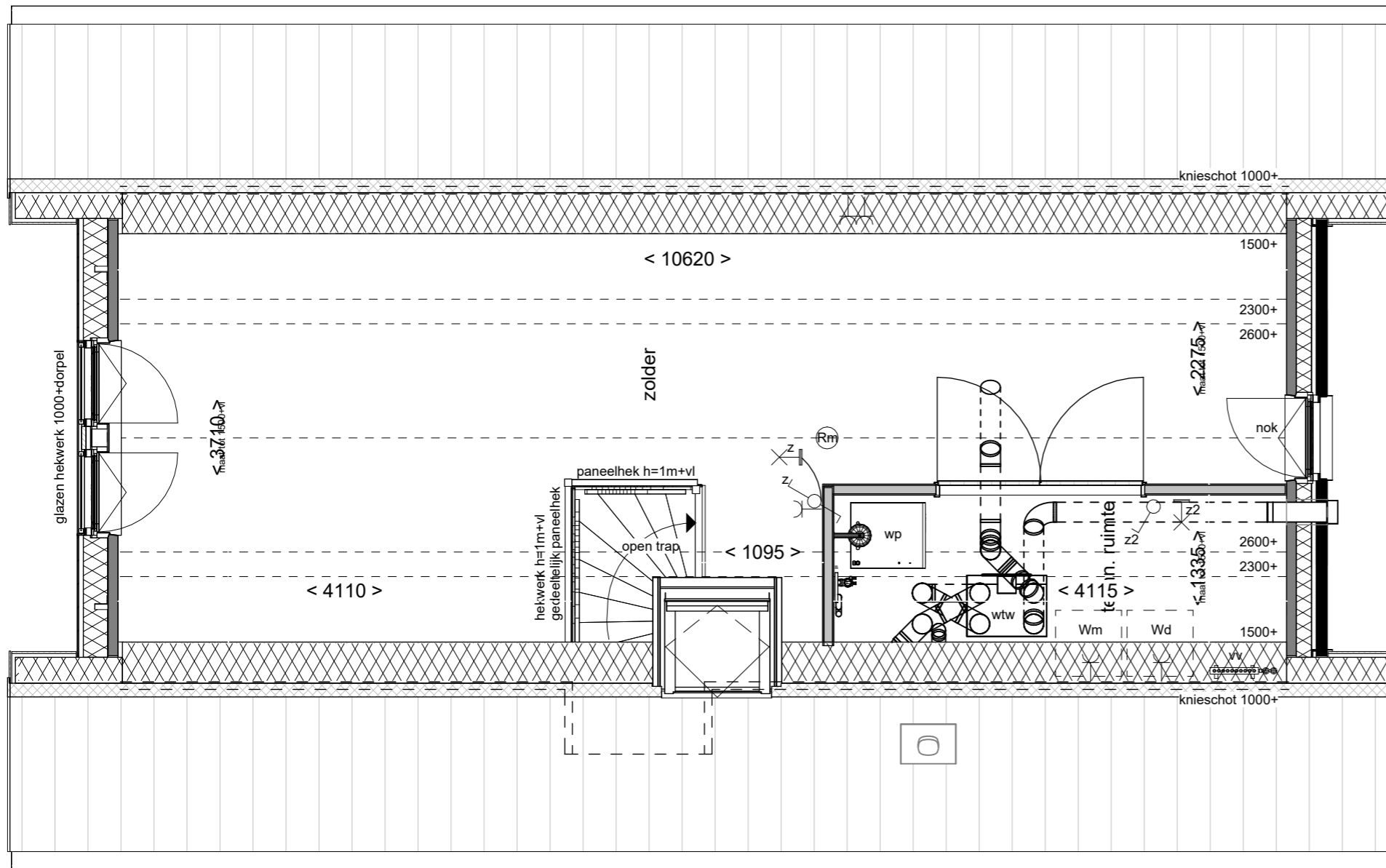

**Indeling met  
techniekkast**

Tekening:

Woningtype: F60-2

Bouwnummer: 21 t/m 31

Optienummer: 1.C.F.70

Bladformaat: A3

Schaal: 1 : 50

Datum: 21-04-2026

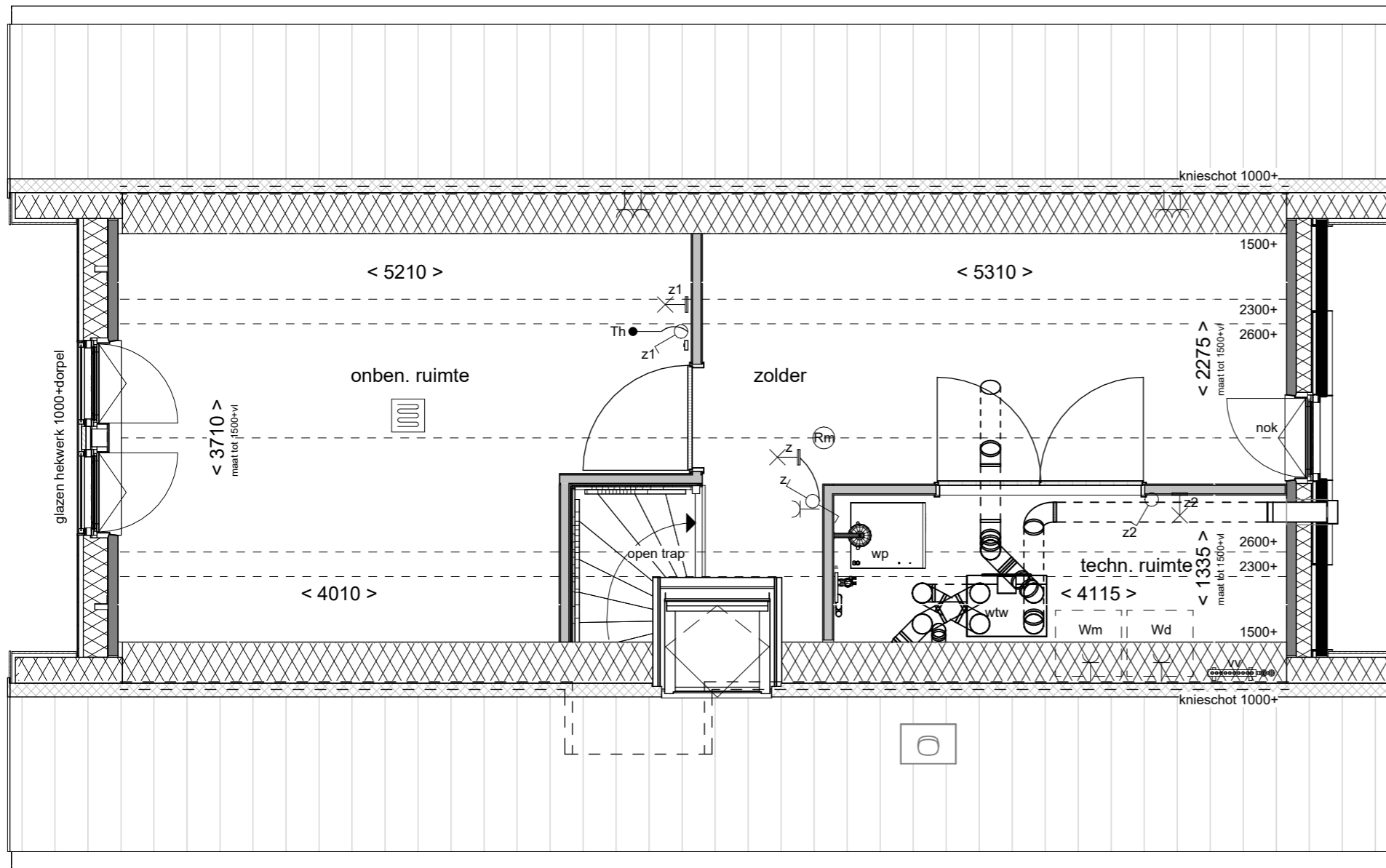

Indeling met één onbenoemde ruimte

Tekening:

Woningtype: F60-2

Bouwnummer: 21 t/m 31

Optienummer: 1.C.F.72

Bladformaat: A3

Schaal: 1 : 50

Datum: 21-04-2026

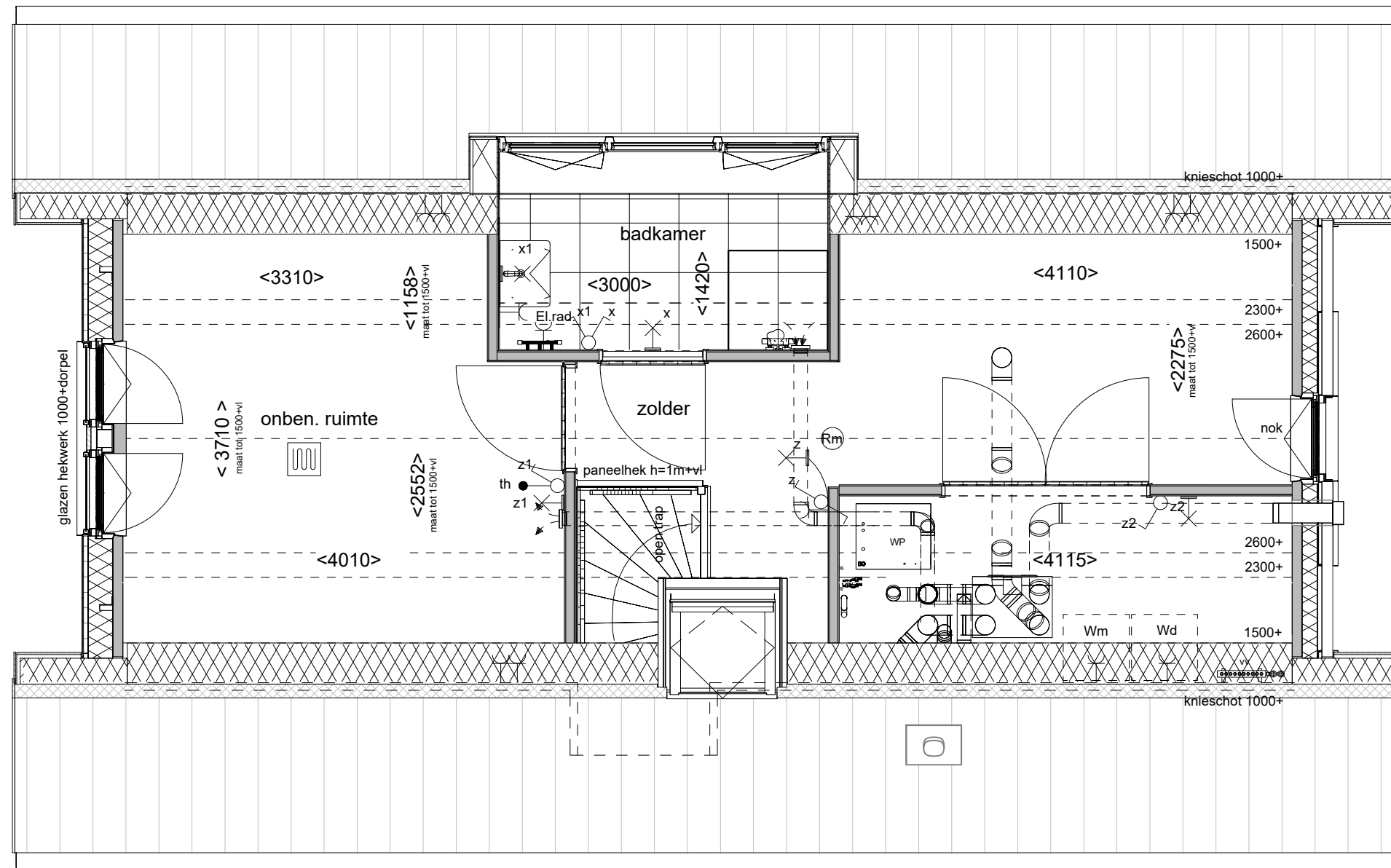

**Wonen aan de Gantel**

Indeling met 1 onb. ruimte + badkamer

Tekening:

Woningtype: F60-2

Bouwnummer: 22 t/m 30

Optienummer: 1.C.F.74B

Bladformaat: A3

Schaal: 1:50

Datum: 21-04-2026

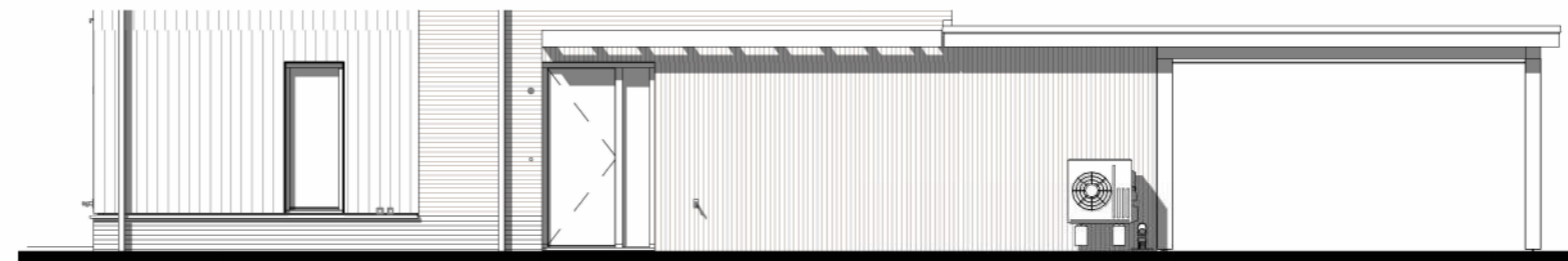
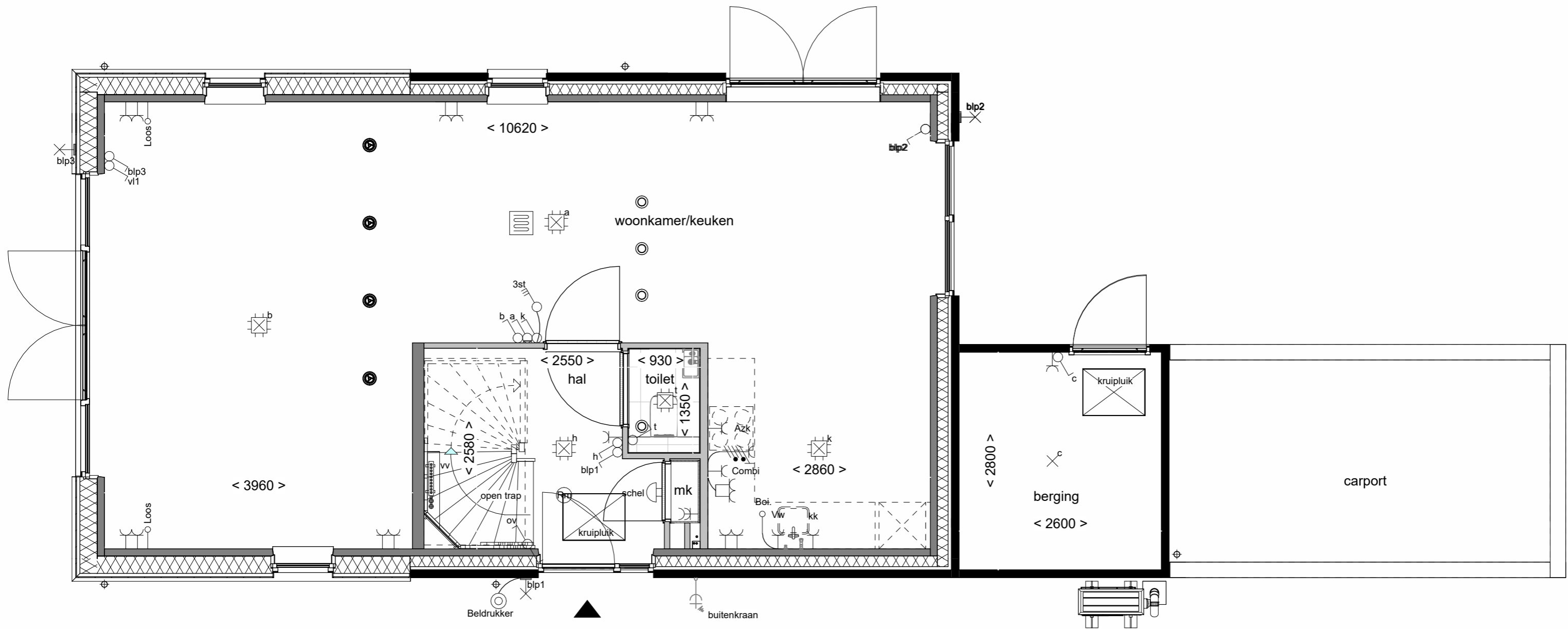

Linkerzijgevel schaal 1:100



vorstvrij buitenkraan  
naast voordeur

Tekening:	
Woningtype:	F60-2
Bouwnummer:	21 t/m 31
Optienummer:	2.K.0.40
Bladformaat:	A3
Schaal:	1:50 / 1:100
Datum:	21-04-2026

