

Renvooi

-  - entree woongebouw
-  - erfgrans
-  - parkeervak eigen terrein
-  - parkeervak openbaar
-  - houten vlonder
-  - pergola
-  - haag laag
-  - haag hoog
-  - water
-  - openbaar groen
-  - wandelpad houtsnippers
-  - voetpad
-  - inrit
-  - straat
-  - talud
-  - boom, positie in overleg met koper
-  - indicatie positie riolering
-  - zone erfdienstbaarheid
-  - klinkerbestrating

parkeerplekken en posities bomen indicatief

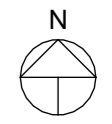

Tekening: **Situatie totaal**

Woningtype: **E60,E60D,F60,F60+**

Bouwnummer: **1 t/m 31**

Bladnummer: **VT-S-00**

Bladformaat: **A3**

Schaal: **1:750**

Datum: **21-04-2026**

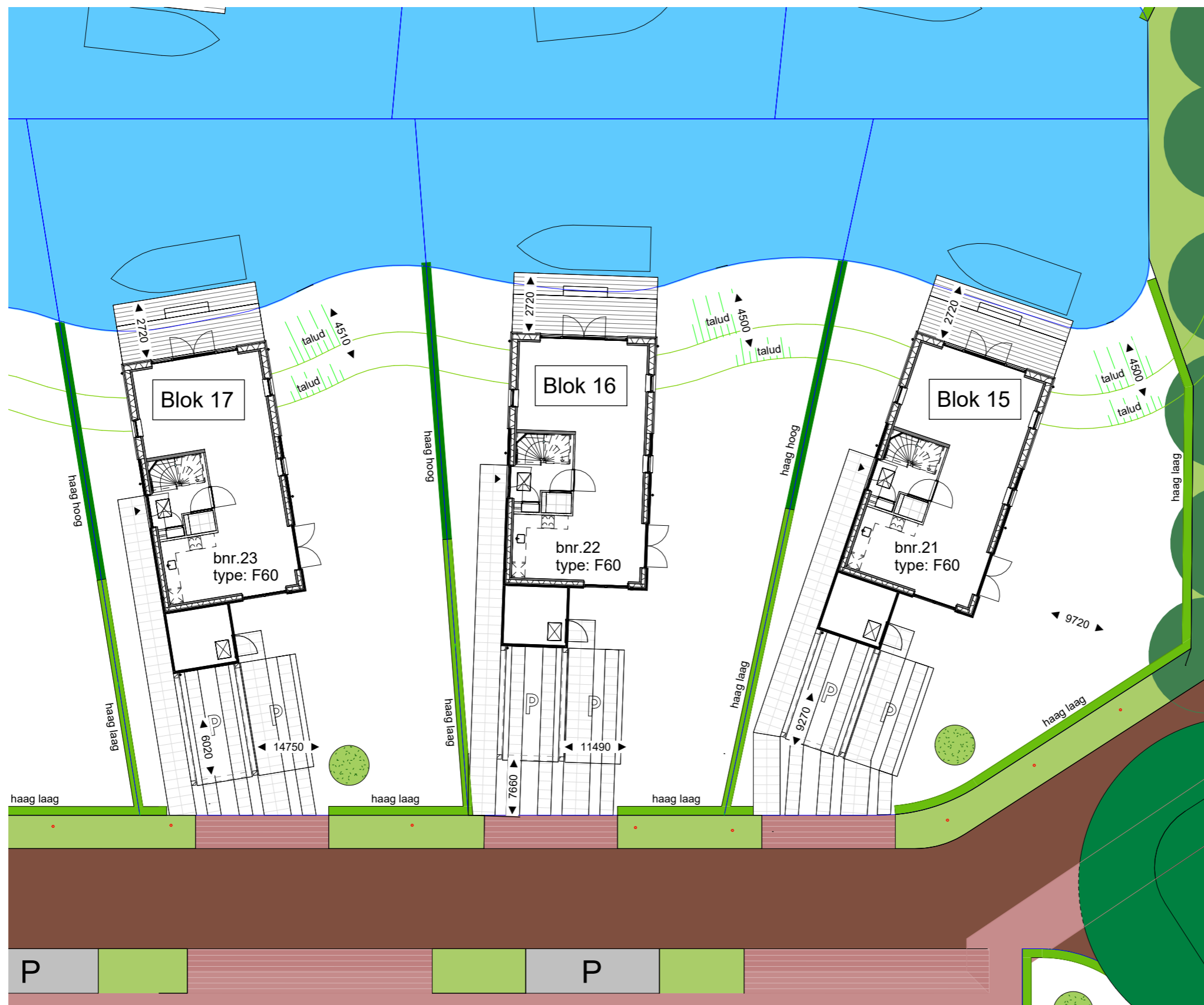

Renvooi

- entree woongebouw
- erfgrens
- parkeervak eigen terrein
- parkeervak openbaar
- houten vlonder
- pergola
- haag laag
- haag hoog
- water
- openbaar groen
- wandelpad houtsnippers
- voetpad
- straat
- talud
- boom, positie in overleg met koper
- indicatie positie riolering
- zone erfdienstbaarheid
- klinkerbestrating

parkeerplekken en posities bomen indicatief

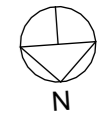

Tekening: **Situatie bnr. 21-23**

Woningtype: **F60**

Bouwnummer: **21, 22, 23**

Bladnummer: **VT-S-07**

Bladformaat: **A3**

Schaal: **1:200**

Datum: **21-04-2026**

Renvooi materialen



dakpan antracietgrijs



metselwerk kleur grijswit gesinterd
code A: EN1166 WF WS



metselwerk kleur bruin nuance
code B: HM1106 WF WS



metselwerk kleur bruin caramel
code C: EN1165 WF WS



gevelbetimmering vuren vergrijsd

Renvooi bouwkundig



entree woning



metselwerk

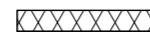

isolatie



dragende wand



niet dragende binnenwand

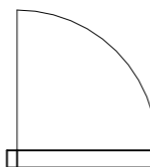

buitendeur

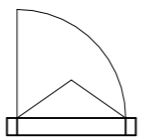

draairaam

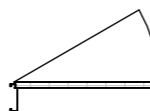

binnendeurkozijn (met bovenlicht)

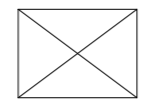

kruipluik

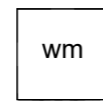

wm opstelplaats wasmachine

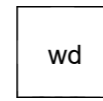

wd opstelplaats wasdroger



kk opstelplaats koelkast

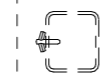

principe opstelling keukenblok

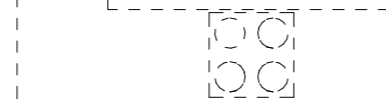

onbenoemde ruimte volgens krijtstreepmethode

Renvooi installaties



aansluitpunt licht, wand



centraaldoos met lichtpunt



armatuur aan de wand



rookmelder



aansluitpunt niet bedraad / loos



aansluitpunt bedraad data, niet afgemonteerd



beldrukker



schel



schakelaar, 1-polig



werkschakelaar tbv PV-panelen



driestandenschakelaar tbv wtw



schakelaar, wissel



schakelaar, serie



pulsschakelaar tbv warmteterugwinunit



wandcontactdoos 1-voudig met beschermingscontact



wandcontactdoos 2-voudig met beschermingscontact



thermostaatleiding, bedraad



wandcontactdoos tbv warmteterugwinunit



wtw mechanische ventilatie-unit incl. warmteterugwinunit



wp warmtepomp



inblaasventiel mechanische ventilatie



afzuigventiel mechanische ventilatie



vv verdeler vloerverwarming



ruimte vzv vloerverwarming



rad elektrische radiator

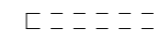

kanalen in het zicht



doucheput



lijngoot douche



buitenkraan

Disclaimer

De op deze tekeningen aangegeven maten zijn circa maten in millimeters en tussen de wanden / vloeren gemeten, waarbij geen rekening is gehouden met enige wandafwerking, plinten, aftimmering, etc. In verband met de nauwkeurige uitwerking van details, constructie, maatvoering, materialen e.d. kunnen er kleine afwijkingen ontstaan ten opzichte van de nu vermelde gegevens. Deze geringe afwijkingen geven geen aanleiding tot verrekening. Aan de op deze tekening aangegeven maten kunnen derhalve geen rechten worden ontleend. De op deze tekeningen aangegeven maatvoering is niet geschikt voor opdrachten aan derden door koper(s). De posities van aansluitingen en installatie onderdelen zijn indicatief op tekening aangegeven. De exacte aantallen en posities zullen na berekening in het werk door de installateurs worden bepaald en kunnen afwijken van deze tekening.



**Wonen aan
de Gantel**

Tekening: **Renvooi**

Woningtype: **E60 / F60 / F60+**

Bouwnummer: **1 t/m 31**

Bladnummer: **VT-0-00c**

Bladformaat: **A3**

Schaal: **1 : 50**

Datum: **21-04-2026**



Voorgevel

Type: F60s
bnr: 23

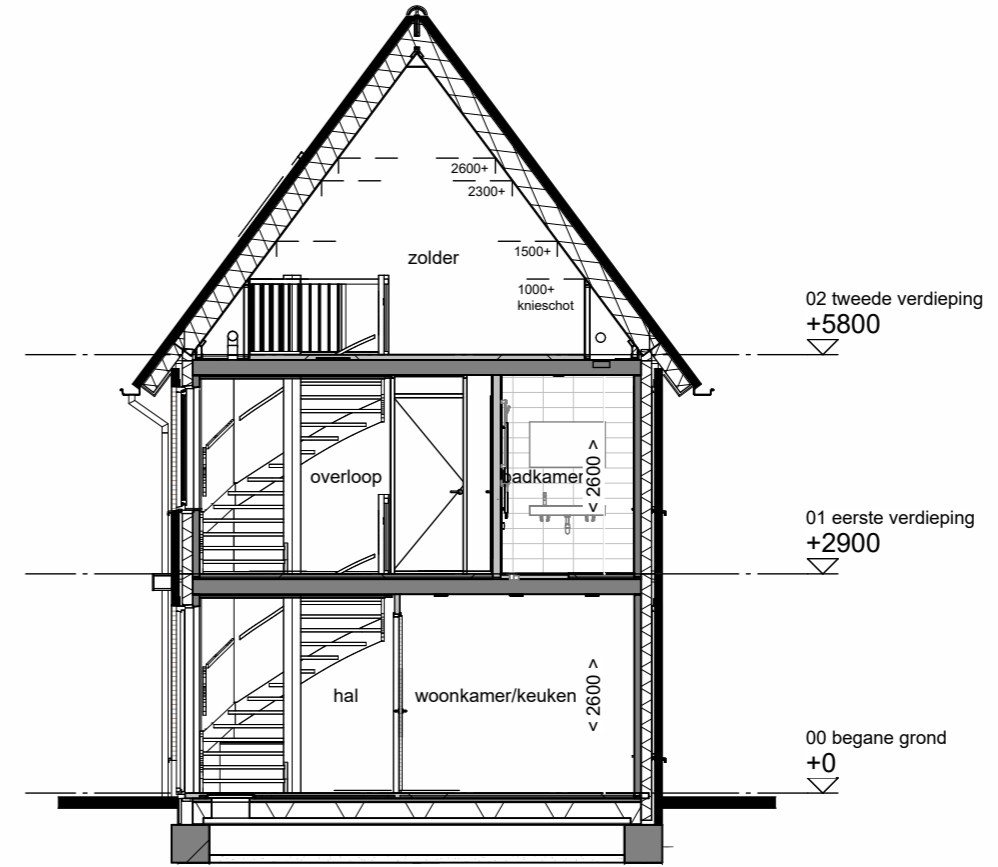

Doorsnede



Achtergevel

Type: F60s
bnr: 23



Tekening: Gevel/Drsn Blok 17

Woningtype: F60s

Bouwnummer: 23

Bladnummer: VT-17-00a

Bladformaat: A3

Schaal: 1 : 100

Datum: 21-04-2026

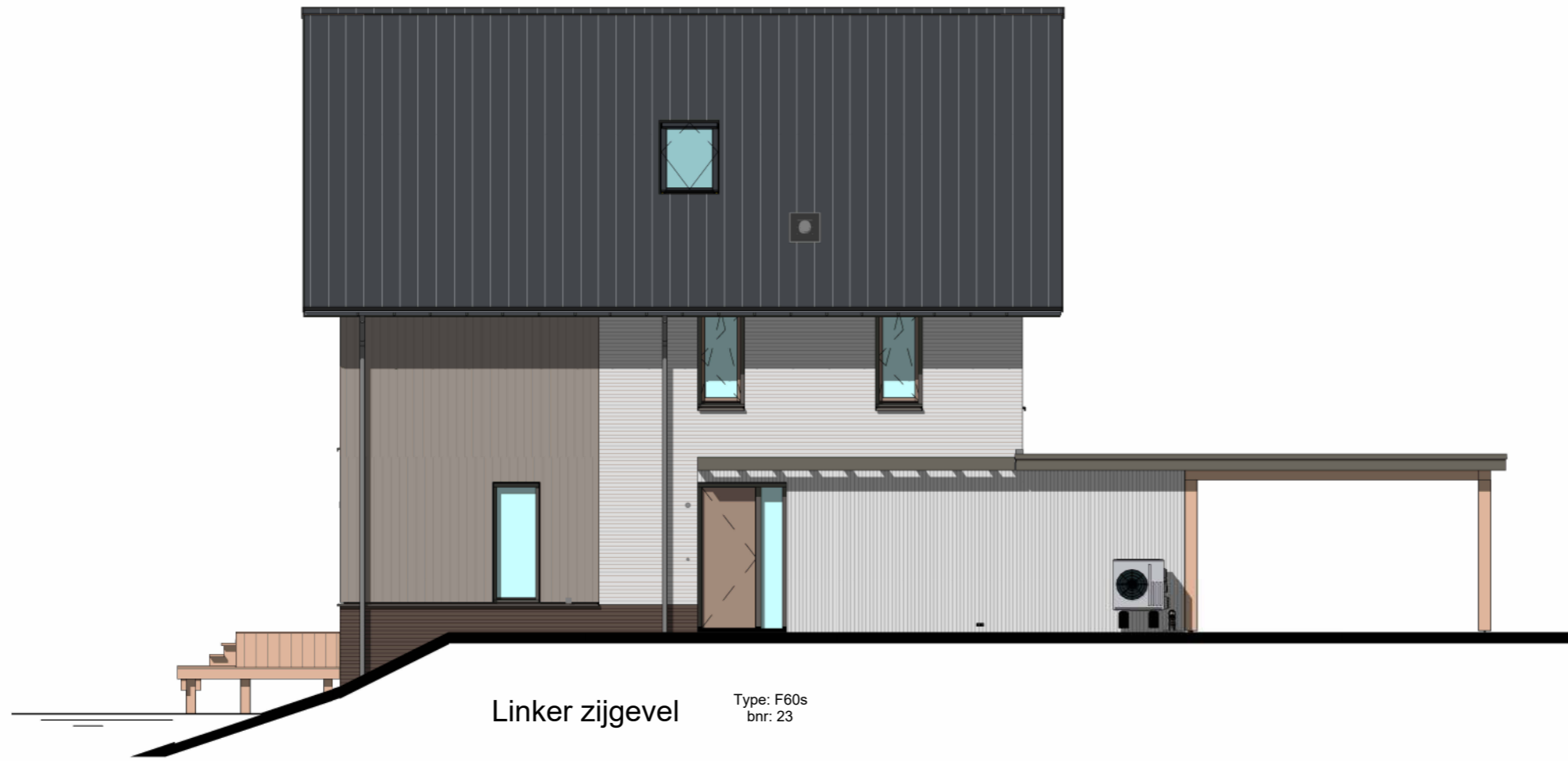

Tekening: Zijgevels blok 17

Woningtype: F60s

Bouwnummer: 23

Bladnummer: VT-17-00b

Bladformaat: A3

Schaal: 1 : 100

Datum: 21-04-2026

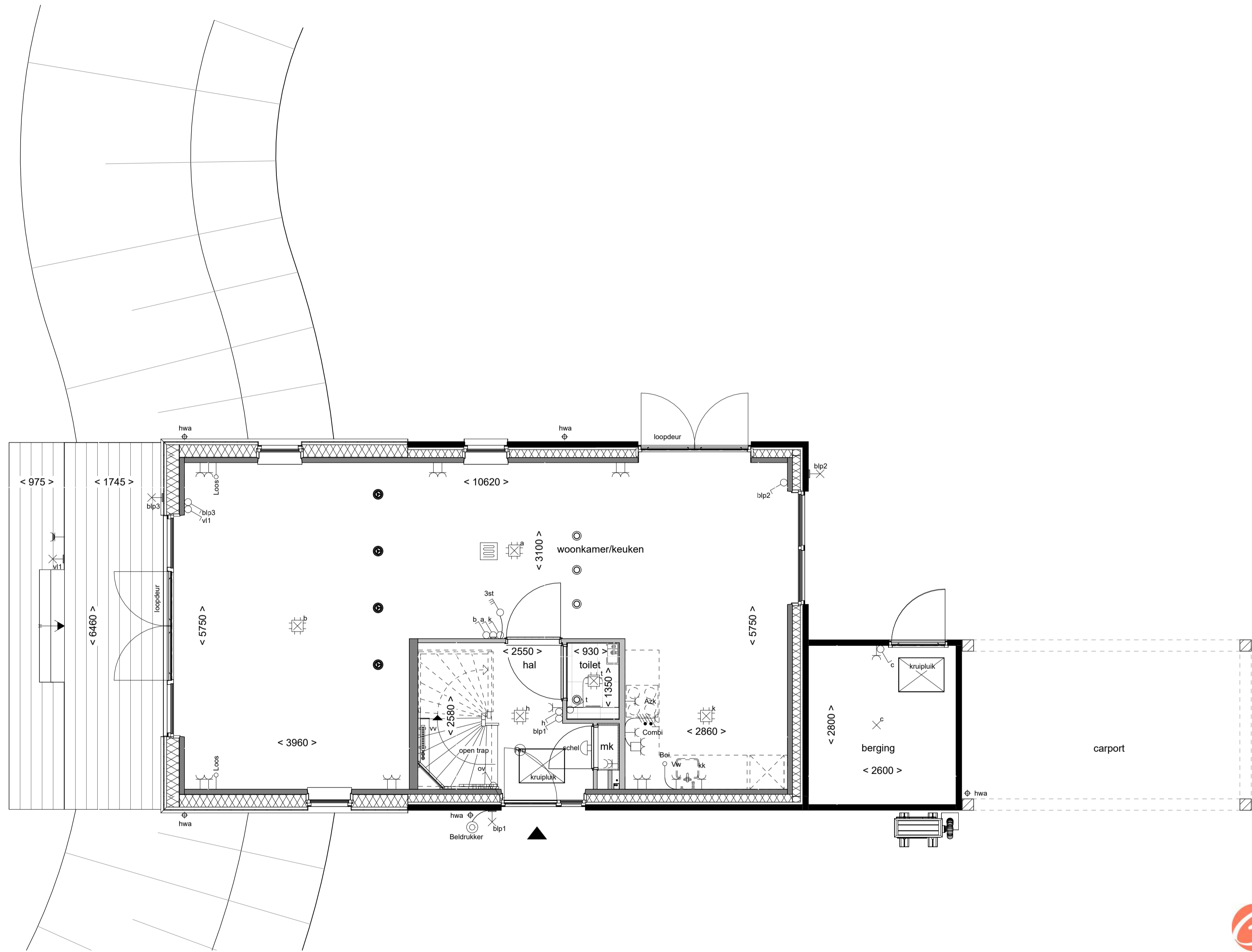

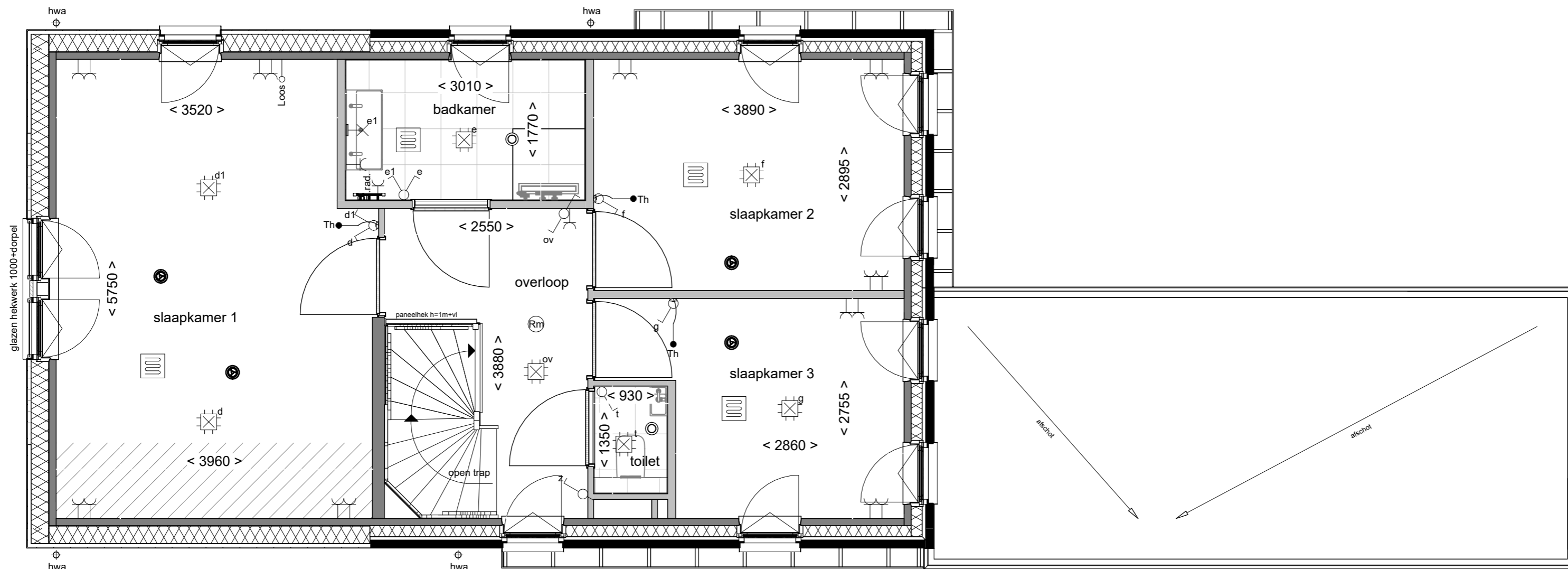

Tekening: **Eerste verdieping**

Woningtype: **F60s**

Bouwnummer: **23**

Bladnummer: **VT-17-23b**

Bladformaat: **A3**

Schaal: **1 : 50**

Datum: **21-04-2026**

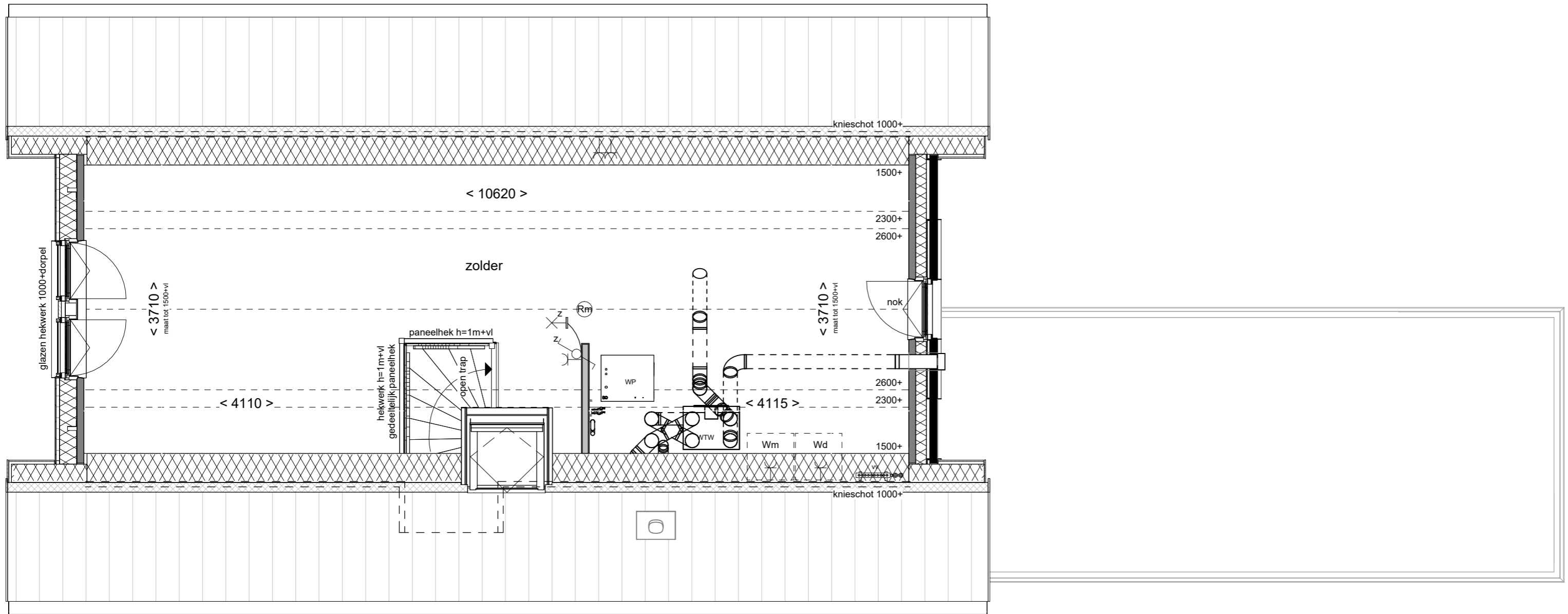

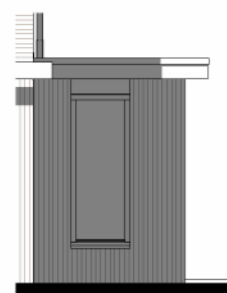
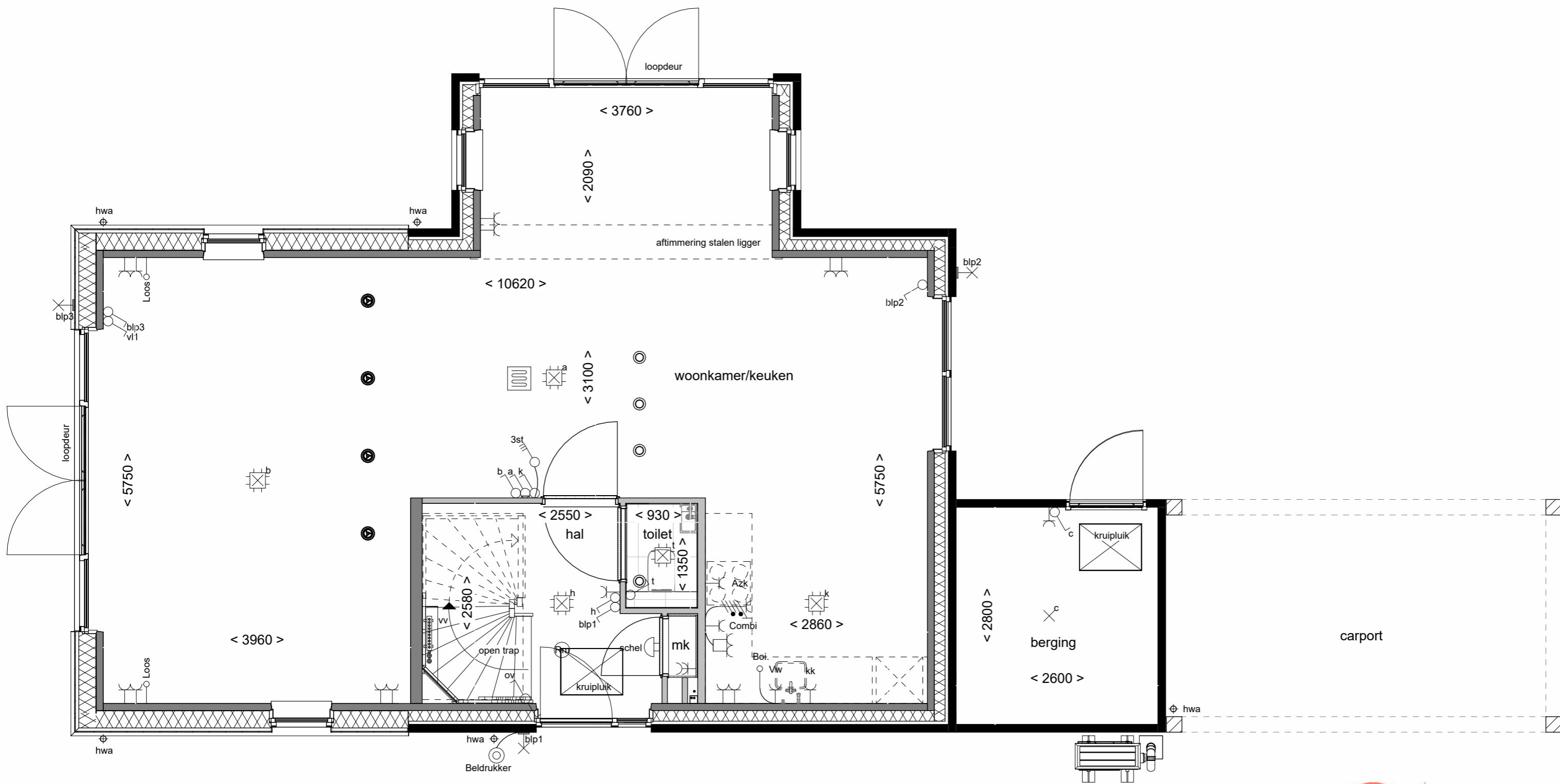

Vooraanzicht



Zijaanzicht schaal 1:100

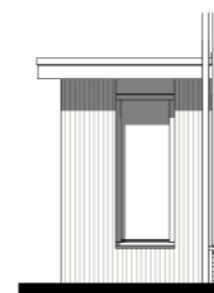

Achteraanzicht

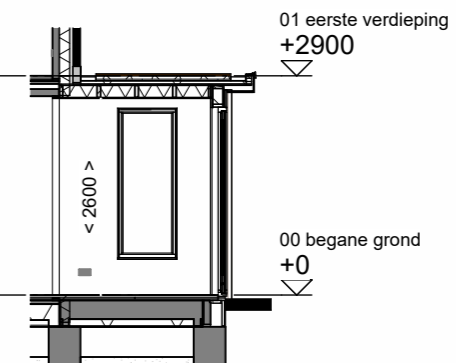

Doorsnede schaal 1:100



Tekening:	Erker
Woningtype:	F60-2
Bouwnummer:	21, 23 t/m 31
Optienummer:	1.A.X.48
Bladformaat:	A3
Schaal:	1:50 / 1:100
Datum:	21-04-2026

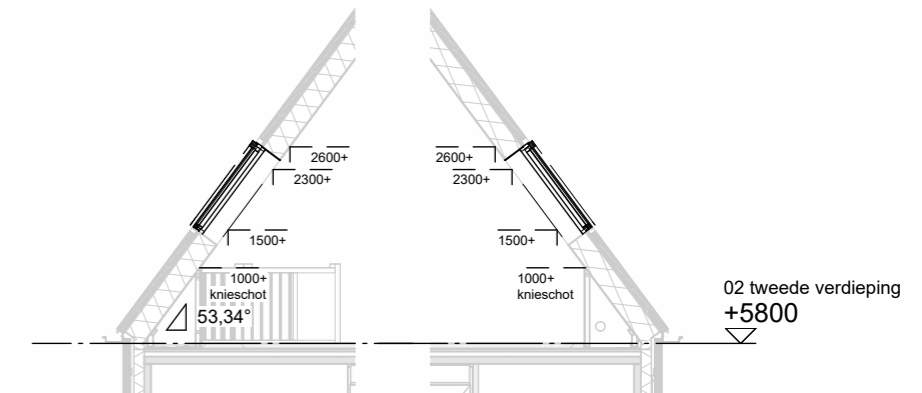
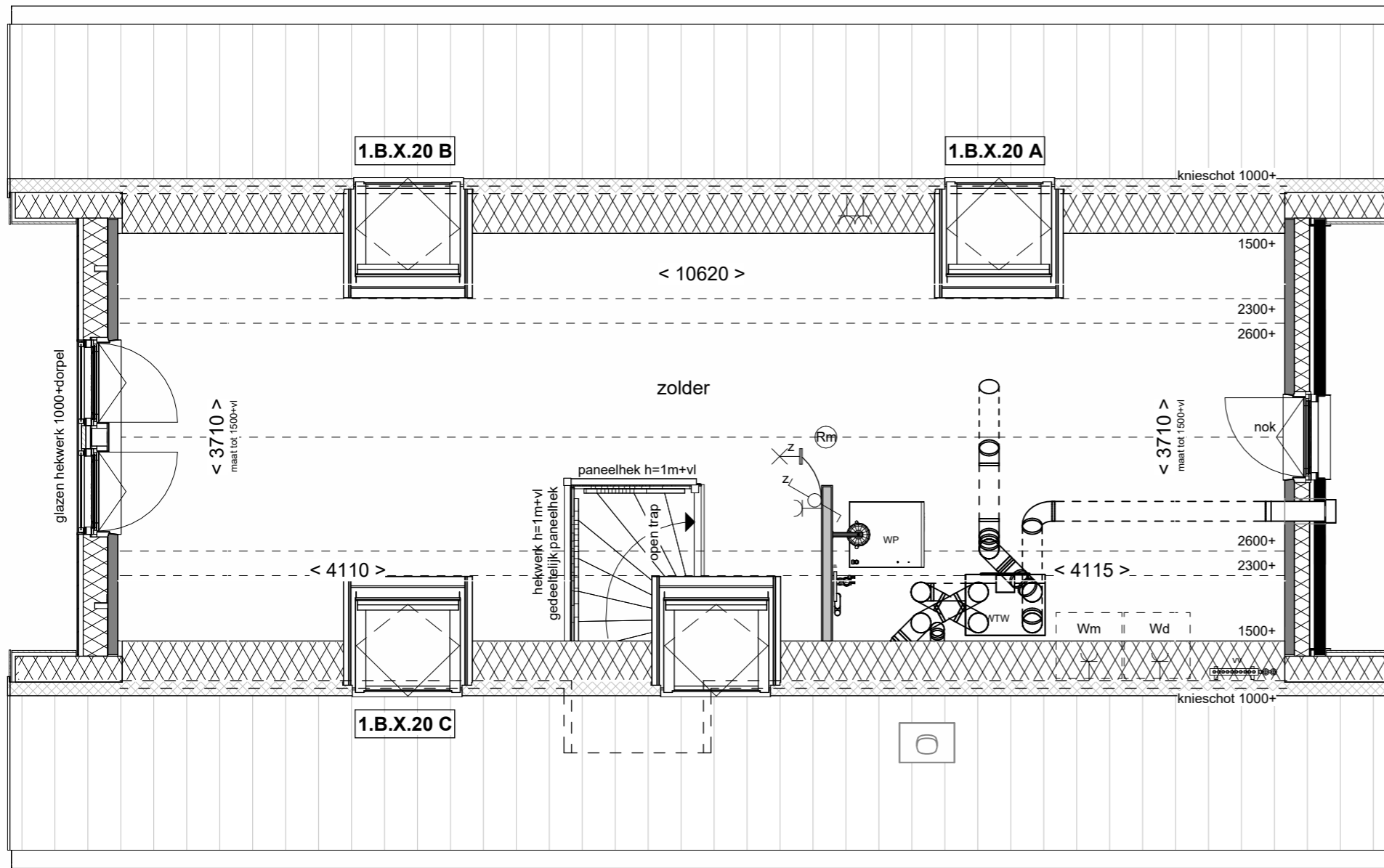

Doorsnedes schaal 1:100

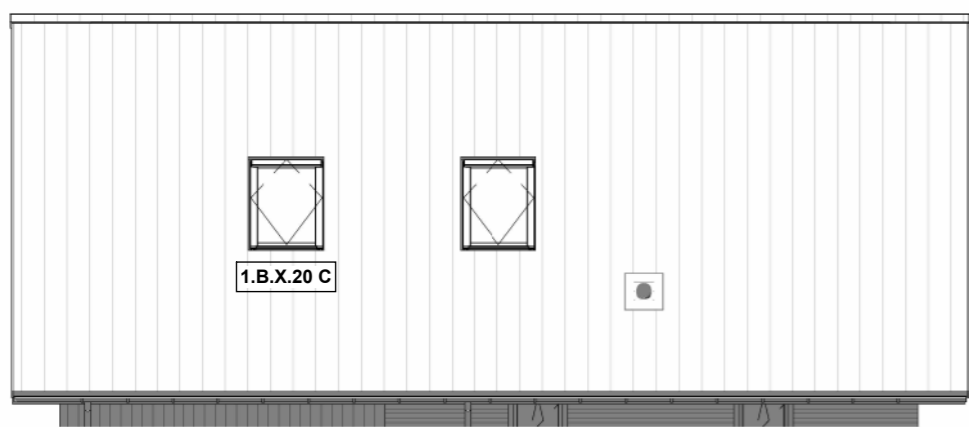

Linker zijaanzicht schaal 1:100

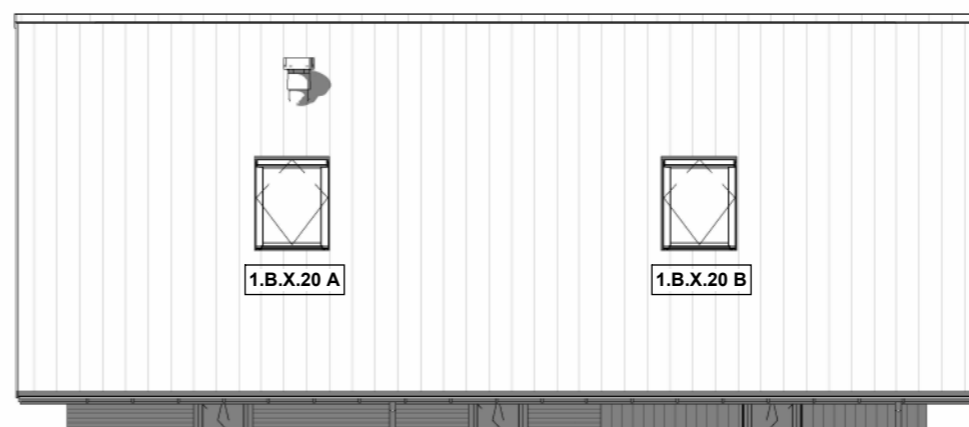

Rechter zijaanzicht schaal 1:100



Tekening: Dakramen zijgevel
 Woningtype: F60-2
 Bouwnummer: 21 t/m 31
 Optienummer: 1.B.X.20
 Bladformaat: A3
 Schaal: 1:50 / 1:100
 Datum: 21-04-2026

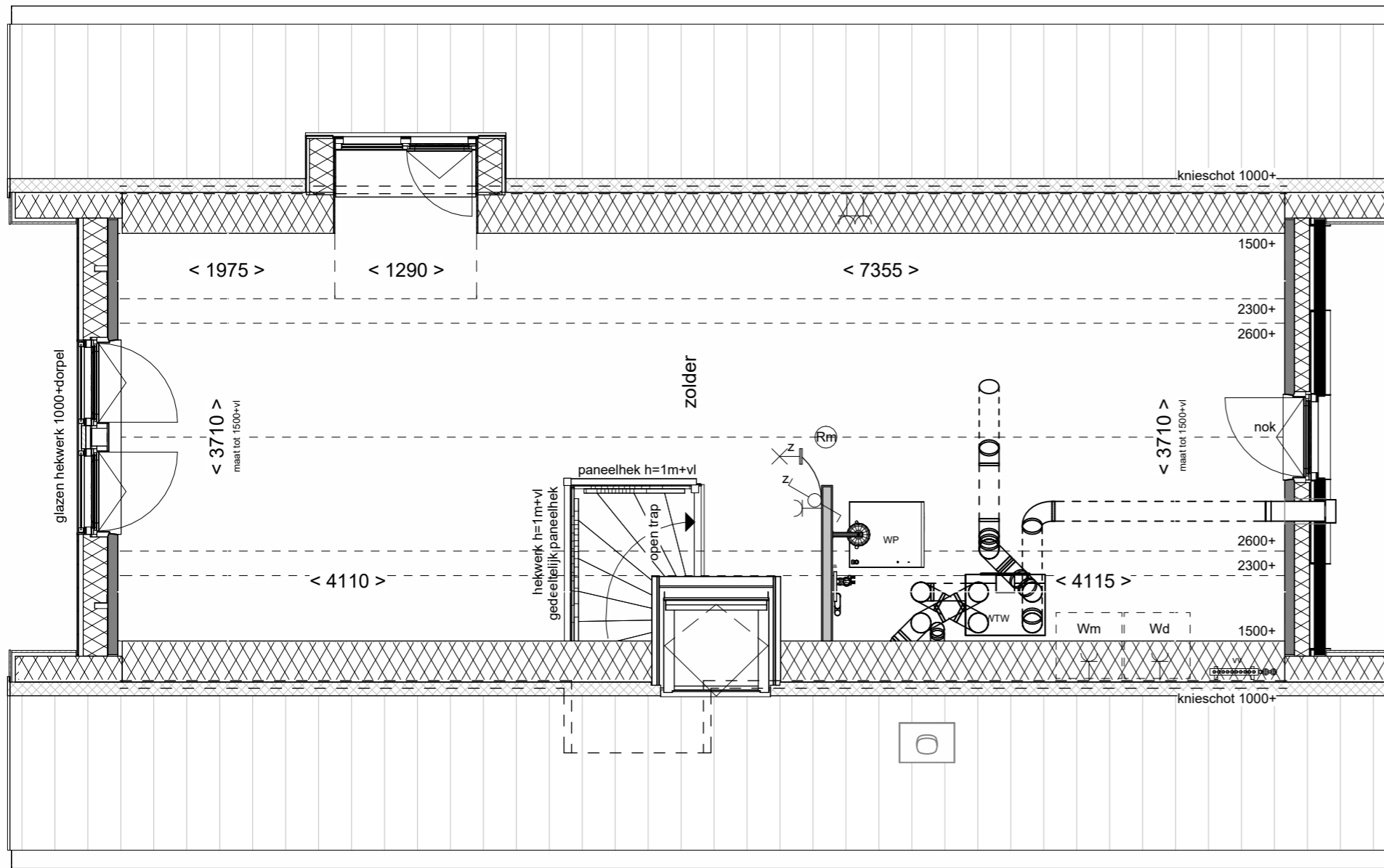

Rechter zijaanzicht schaal 1:100

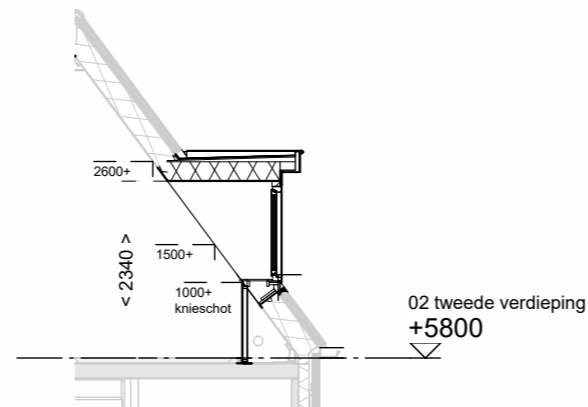

Doorsnede schaal 1:100



Dakkapel
zijgevel 130cm

Tekening:

Woningtype: F60-2

Bouwnummer: 22 t/m 30

Optienummer: 1.B.X.36

Bladformaat: A3

Schaal: 1:50 / 1:100

Datum: 21-04-2026

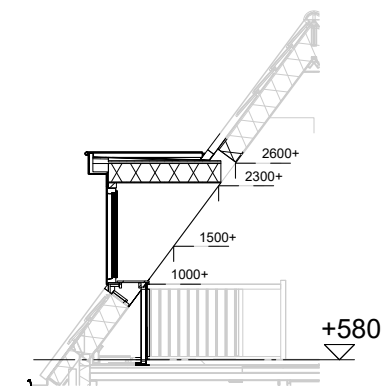
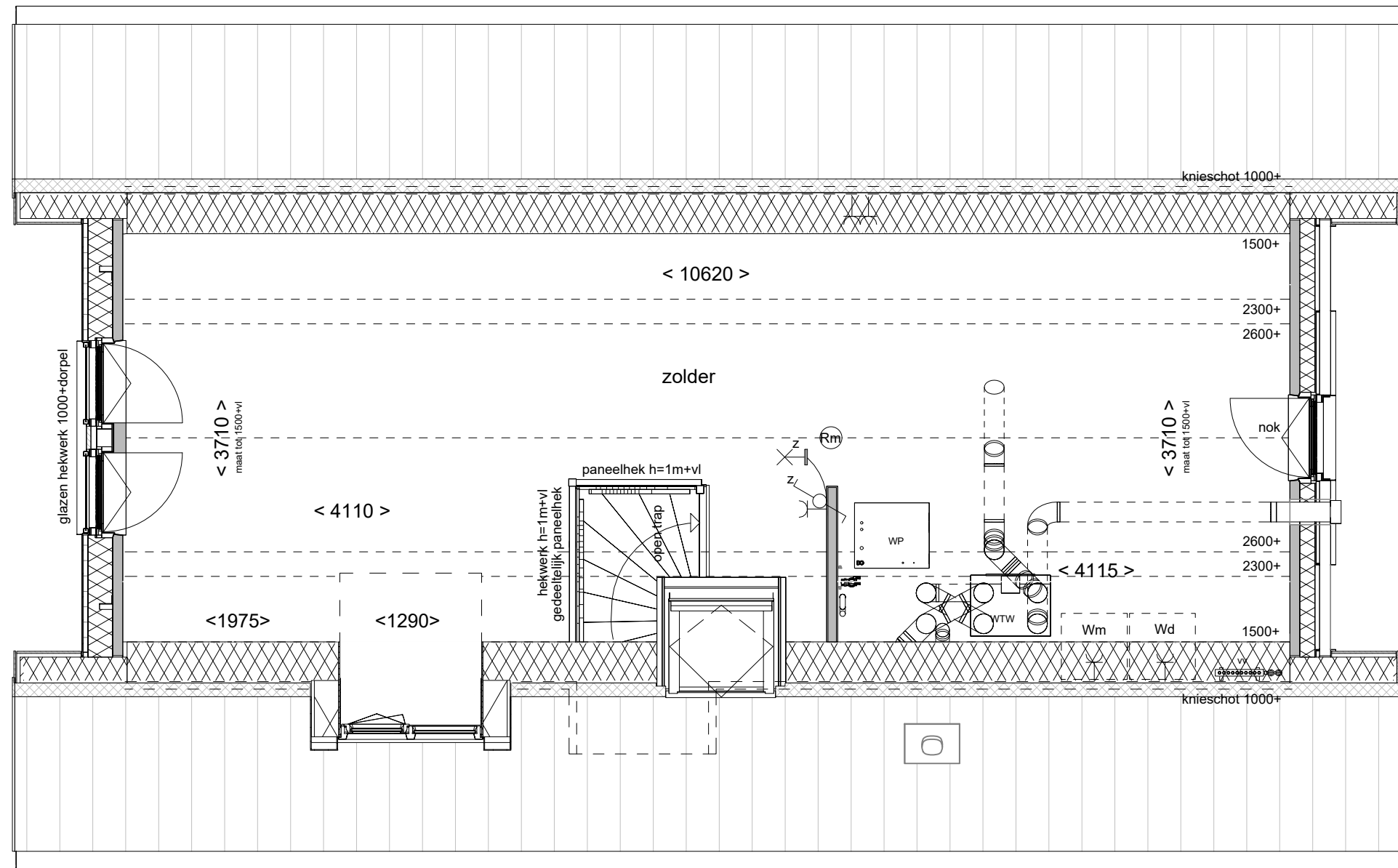

Doorsnede schaal 1:100



Dakkapel zijgevel

Tekening: 130cm

Woningtype: F60-2

Bouwnummer: 21-25 en 28-31

Optienummer: 1.B.X.36

Bladformaat: A3

Schaal: 1:50 / 1:100

Datum: 21-04-2026

02 tweede verdieping

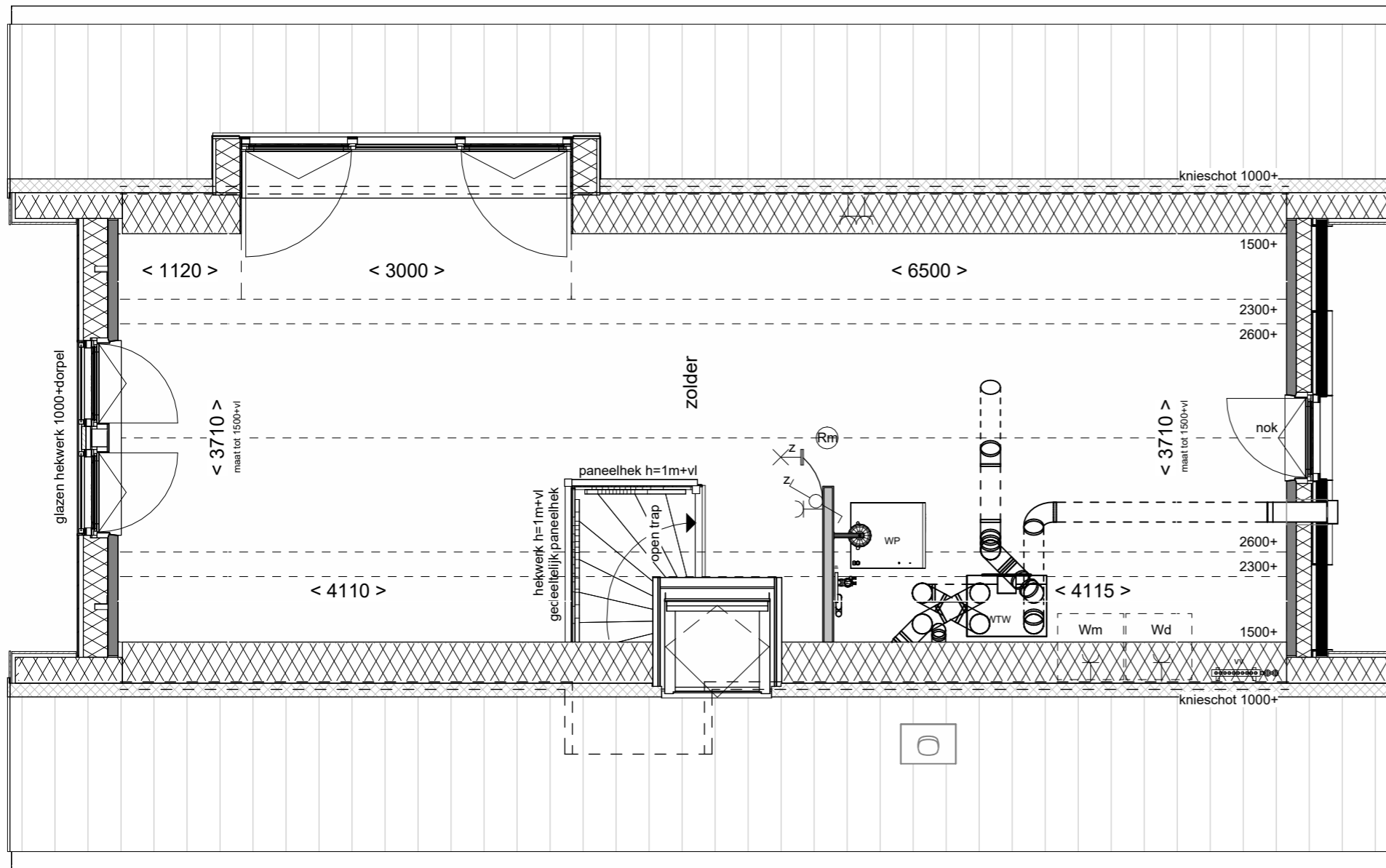

Rechter zijaanzicht schaal 1:100

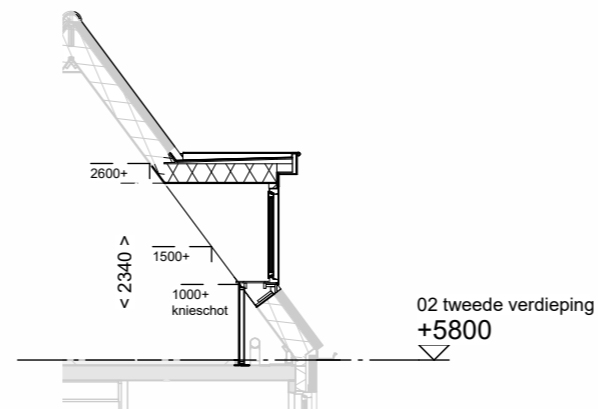

Doorsnede schaal 1:100



Dakkapel
zijgevel 300cm

Tekening:

Woningtype: F60-2

Bouwnummer: 22 t/m 30

Optienummer: 1.B.X.38

Bladformaat: A3

Schaal: 1:50 / 1:100

Datum: 21-04-2026

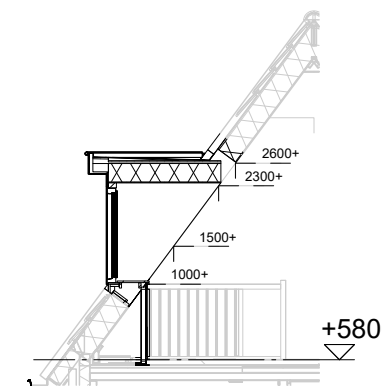
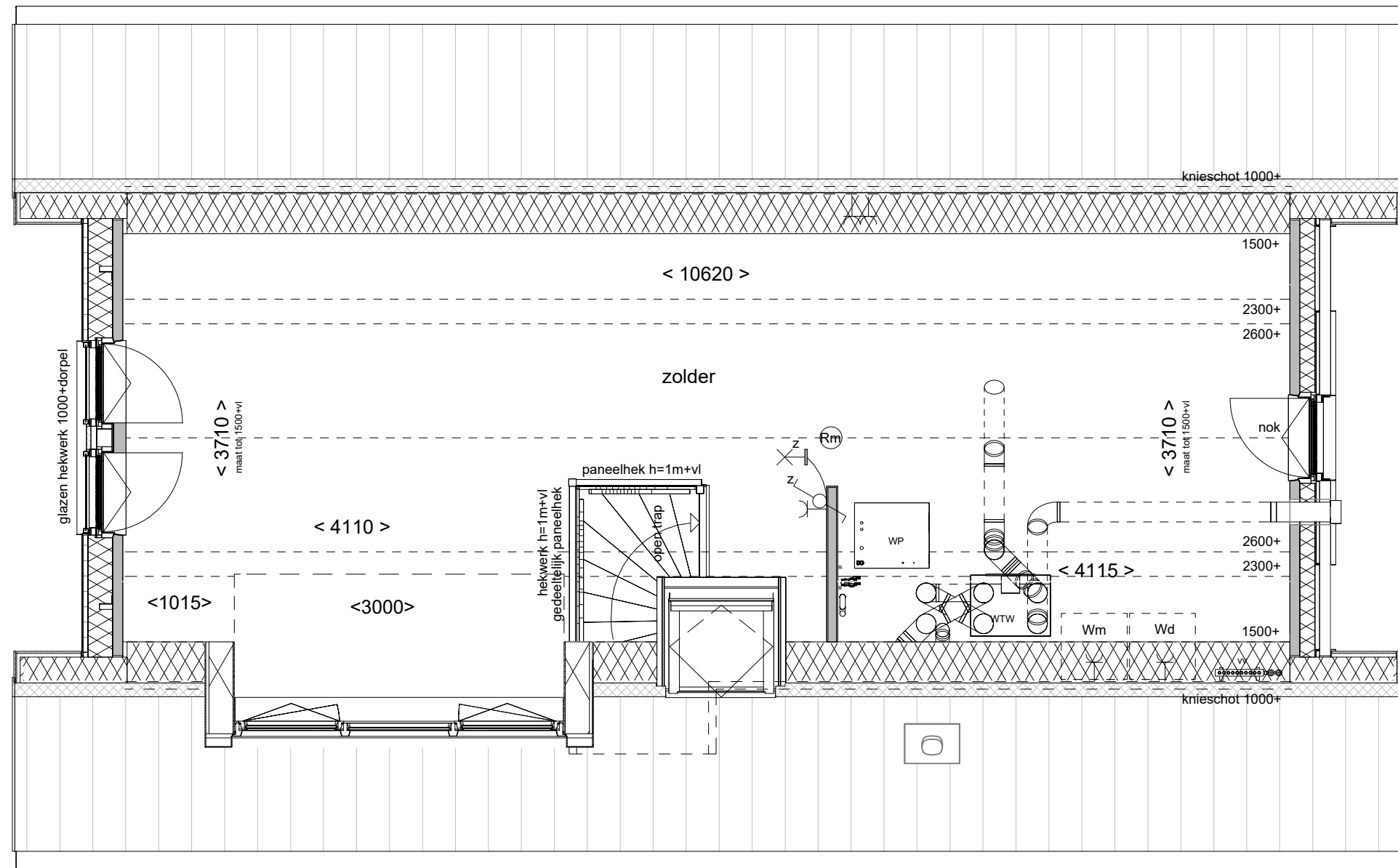

Doorsnede schaal 1:100



Dakkapel zijgevel
300cm

Tekening:

Woningtype: F60-2

Bouwnummer: 21-25 en 28-31

Optienummer: 1.B.X.38

Bladformaat: A3

Schaal: 1:50 / 1:100

Datum: 21-04-2026

02 tweede verdieping

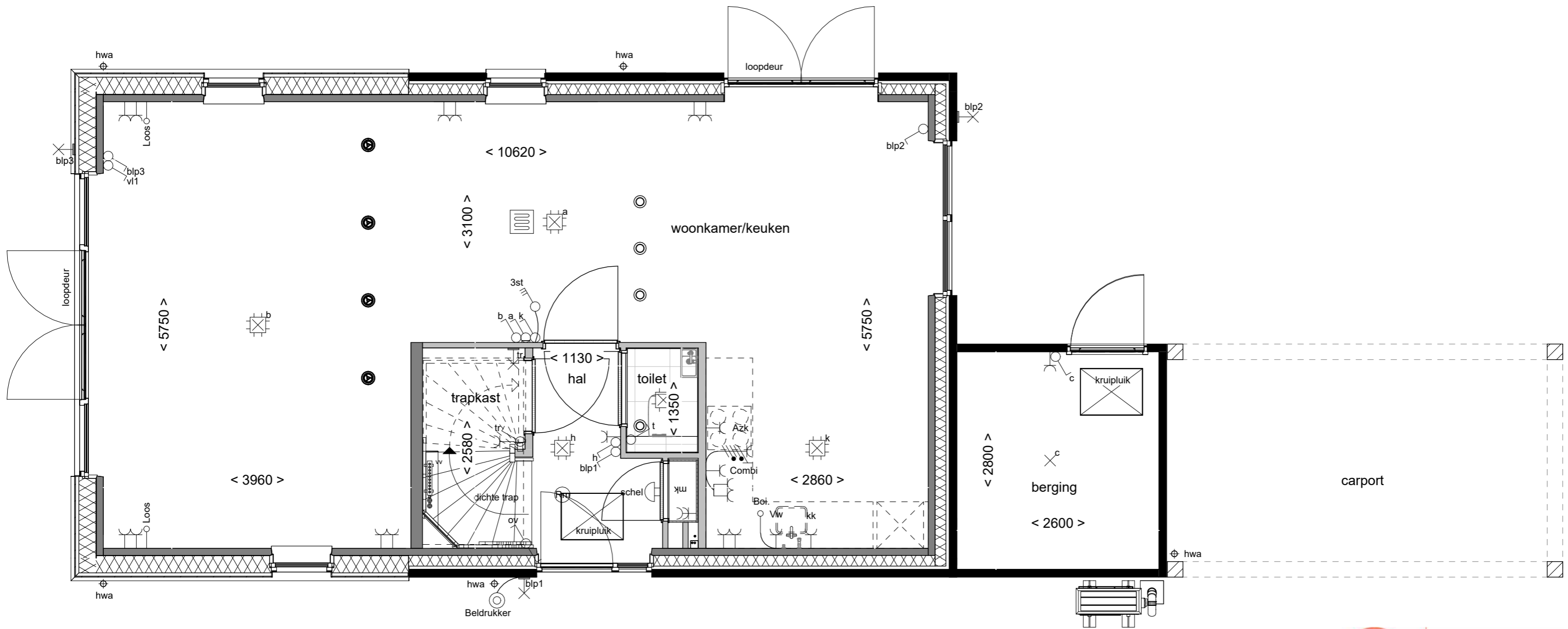

Tekening: Trapkast

Woningtype: F60-2

Bouwnummer: 21 t/m 31

Optienummer: 1.C.F.10

Bladformaat: A3

Schaal: 1 : 50

Datum: 21-04-2026

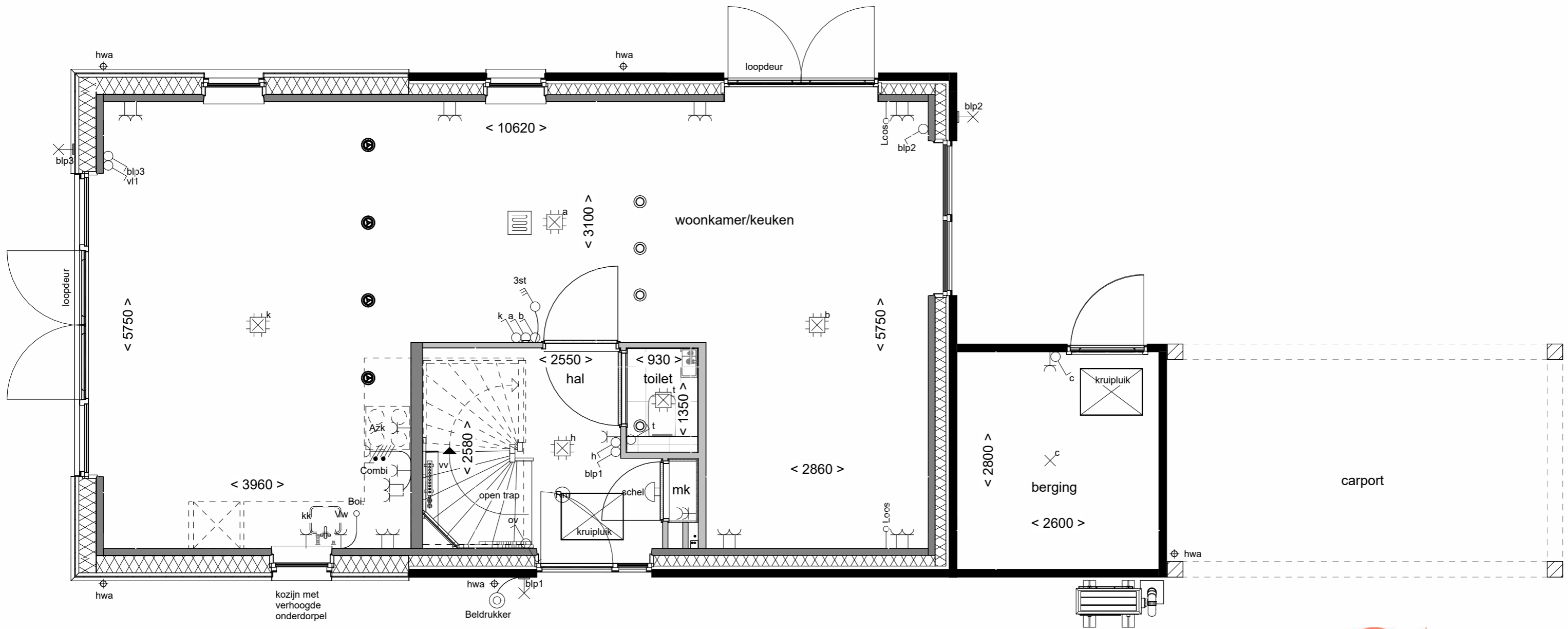

Tekening: **Keuken achterzijde**

Woningtype: **F60-2**

Bouwnummer: **21 t/m 31**

Optienummer: **1.C.F2.12**

Bladformaat: **A3**

Schaal: **1:50 / 1:100**

Datum: **21-04-2026**

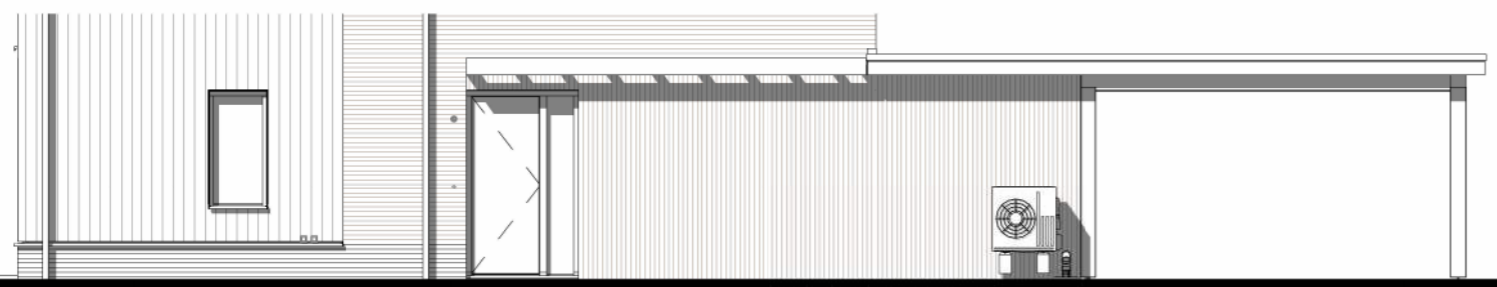

kozijn met verhoogde onderdorpel t.b.v. keuken

Zijaanzicht schaal 1:100

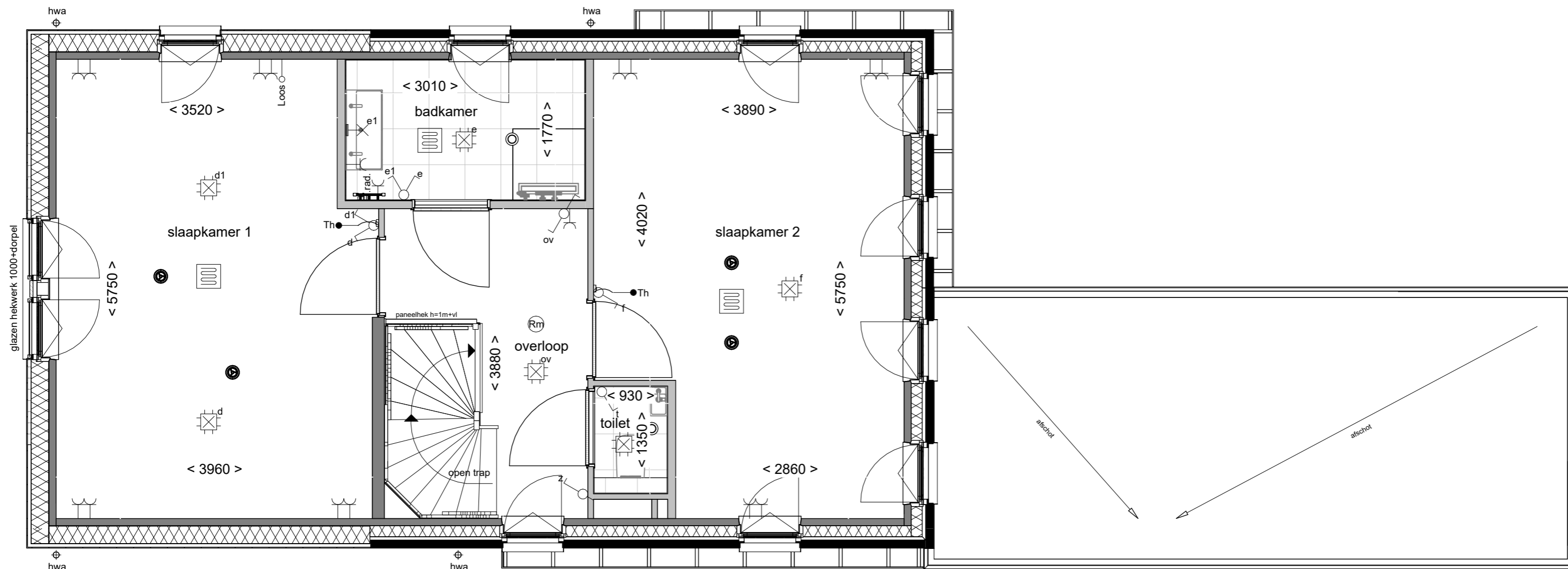

Samenvoegen
slaapkamers voor

Tekening:

Woningtype: F60-2

Bouwnummer: 21 t/m 31

Optienummer: 1.C.F.30

Bladformaat: A3

Schaal: 1 : 50

Datum: 21-04-2026

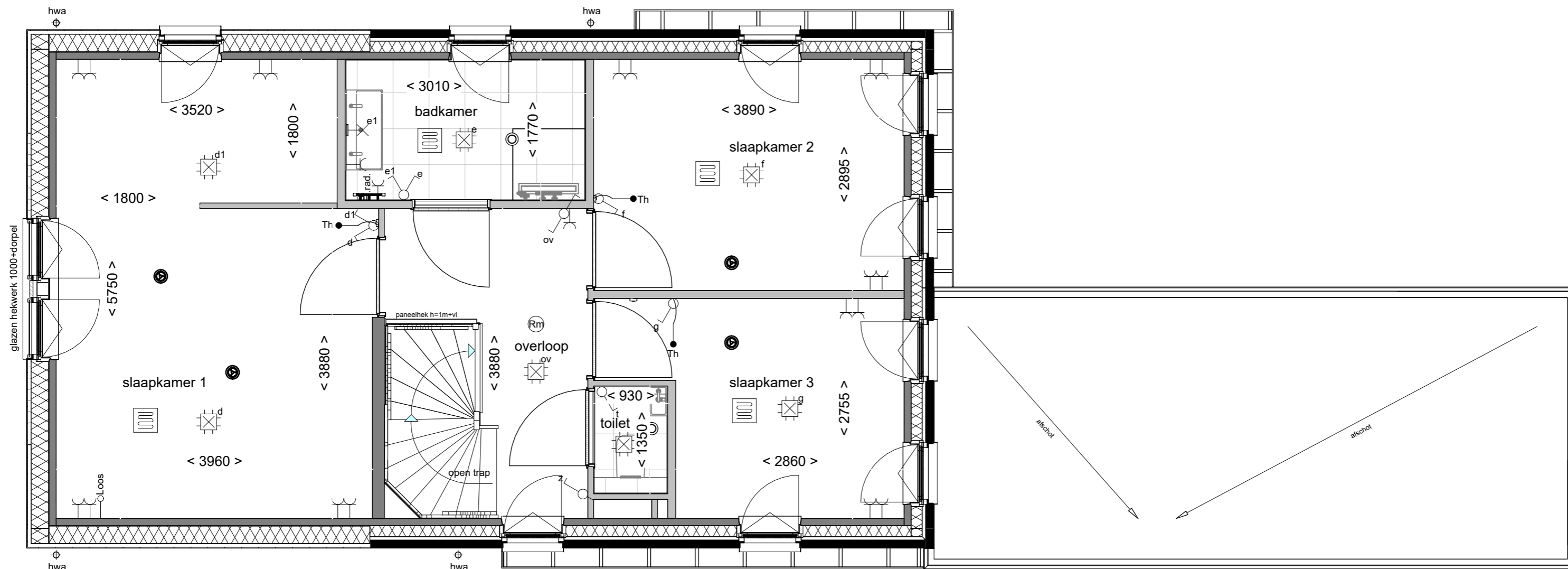

**Wonen aan
de Gantel**

Samenvoegen slpk
voor met inloopkast

Tekening:

Woningtype: F60-2

Bouwnummer: 21 t/m 31

Optienummer: 1.C.F.32

Bladformaat: A3

Schaal: 1 : 50

Datum: 21-04-2026

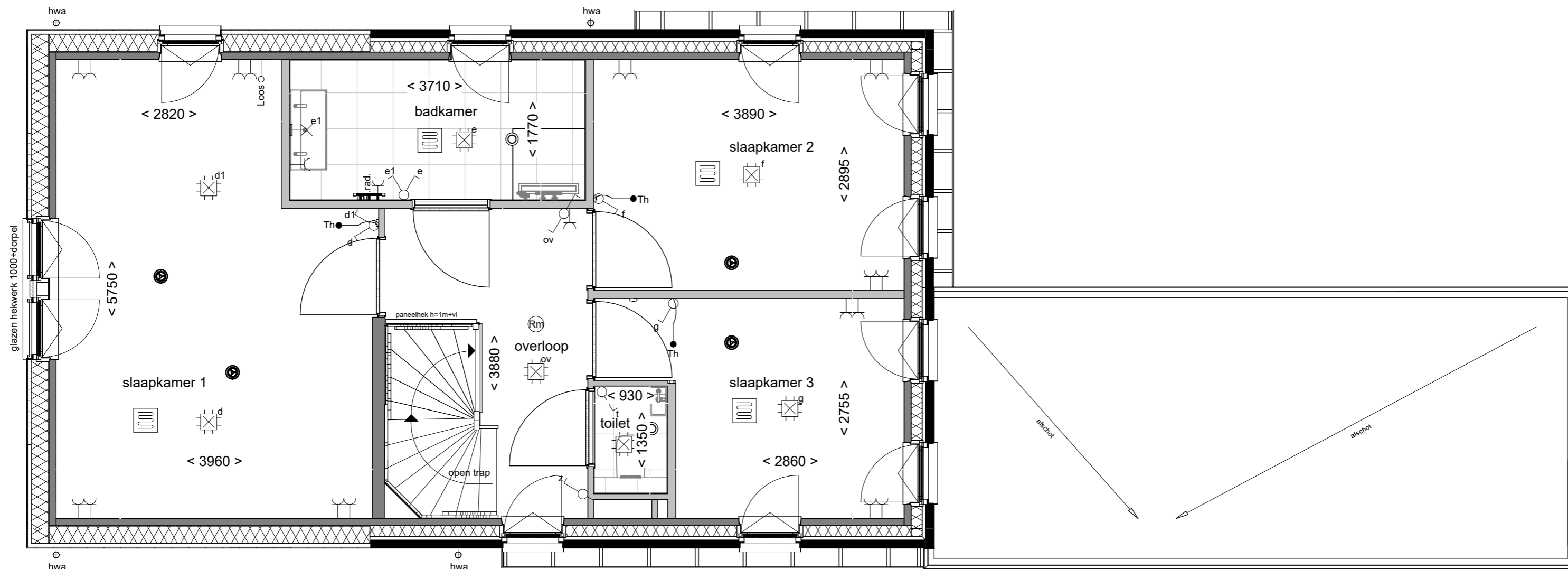

Tekening: **Badkamer vergroten**

Woningtype: **F60-2**

Bouwnummer: **21 t/m 31**

Optienummer: **1.C.F.42**

Bladformaat: **A3**

Schaal: **1 : 50**

Datum: **21-04-2026**

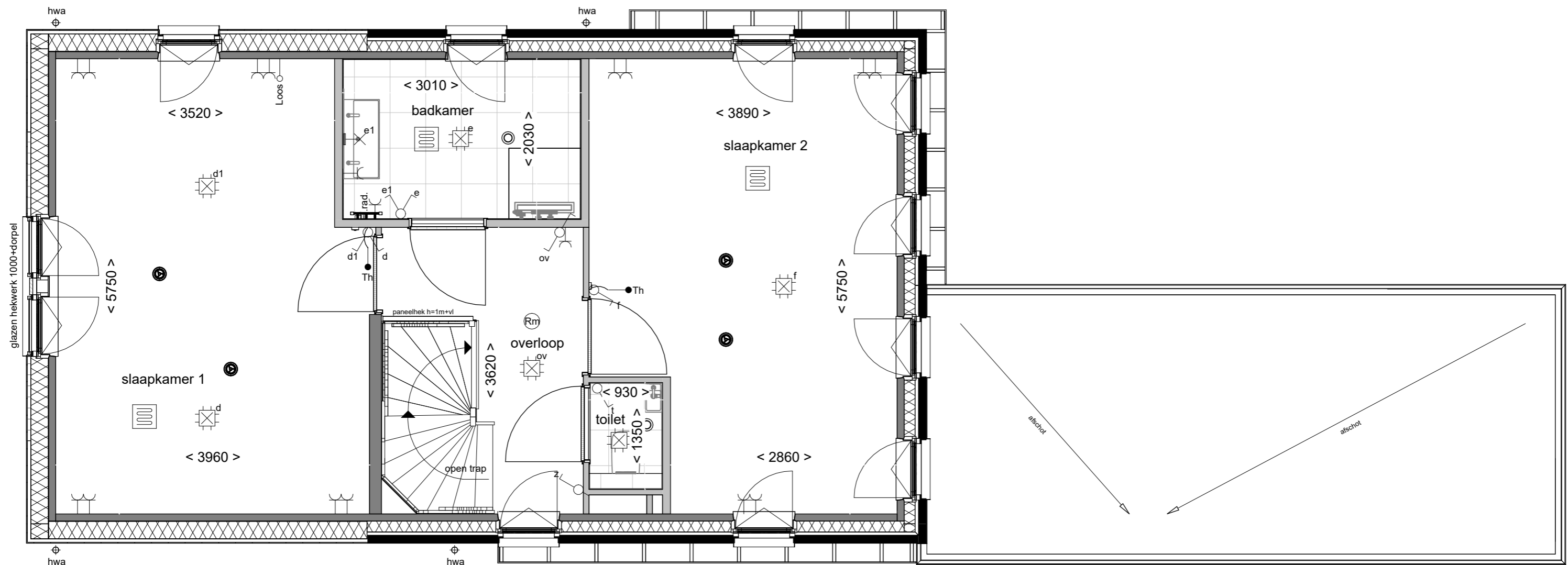

alleen i.c.m. optie 1.C.F.30



Tekening: **Badkamer verbreden**

Woningtype: **F60-2**

Bouwnummer: **21 t/m 31**

Optienummer: **1.C.F.44**

Bladformaat: **A3**

Schaal: **1 : 50**

Datum: **21-04-2026**

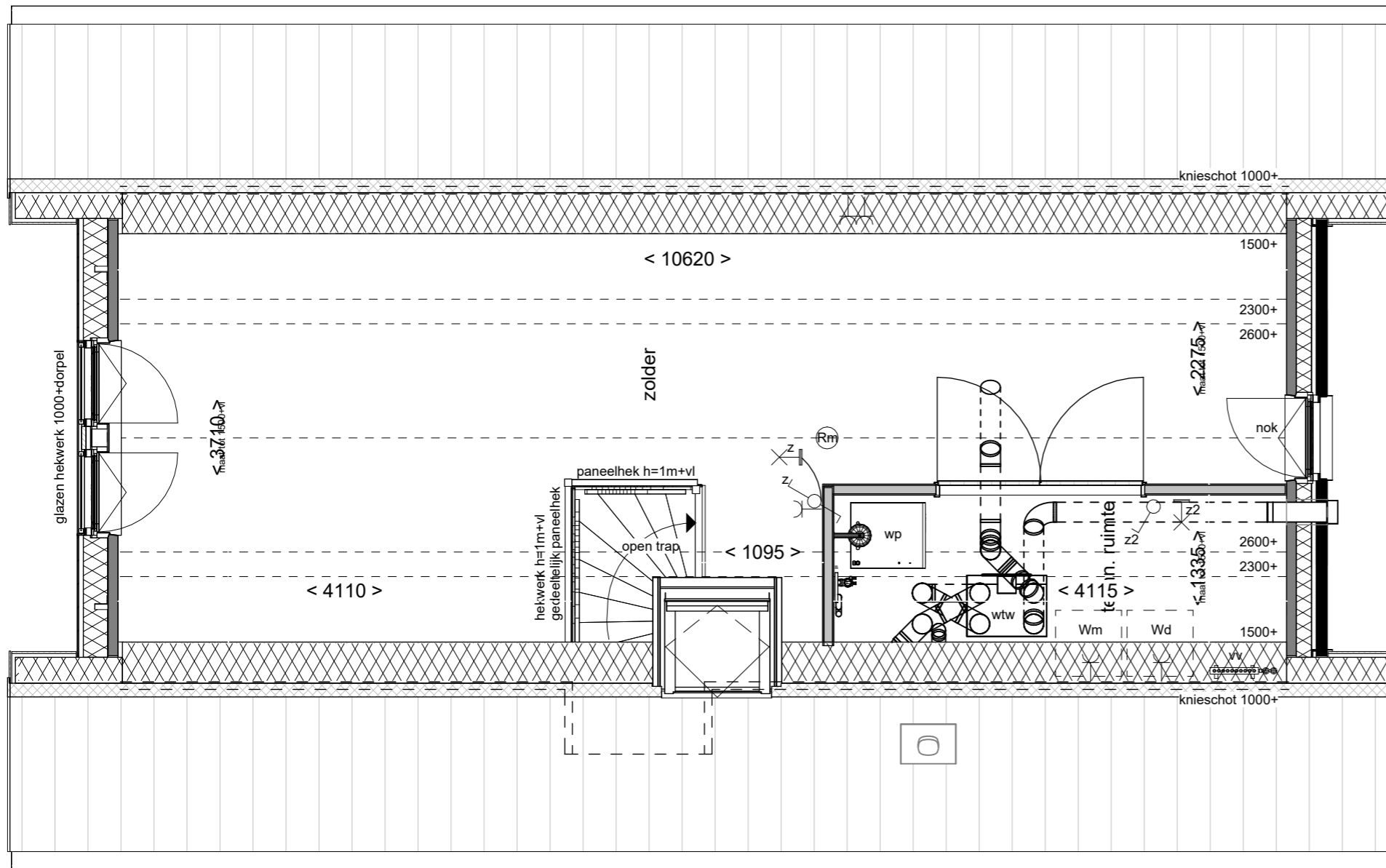

Indeling met
techniekkast

Tekening:

Woningtype: F60-2

Bouwnummer: 21 t/m 31

Optienummer: 1.C.F.70

Bladformaat: A3

Schaal: 1 : 50

Datum: 21-04-2026

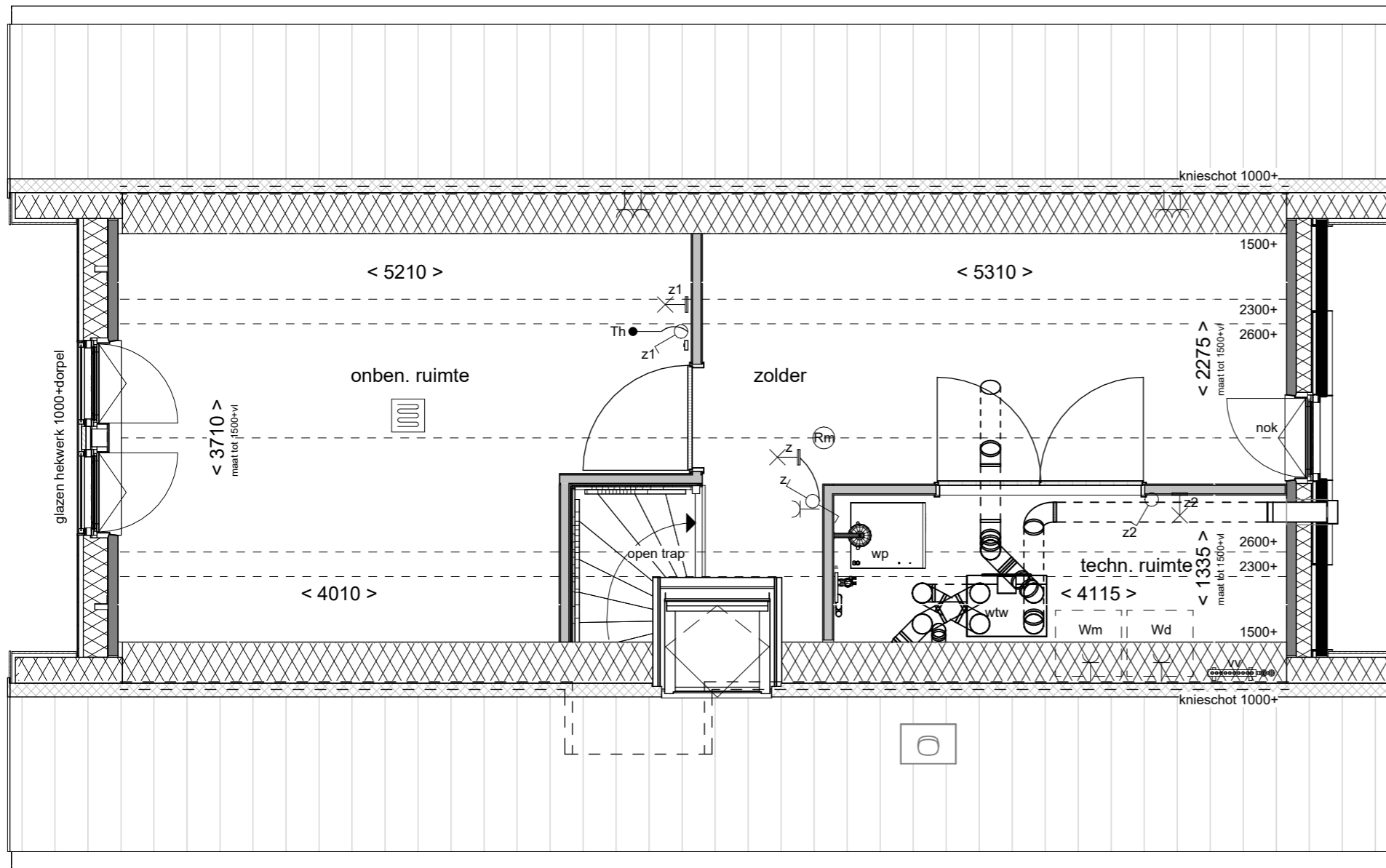

Indeling met één onbenoemde ruimte

Tekening:

Woningtype: F60-2

Bouwnummer: 21 t/m 31

Optienummer: 1.C.F.72

Bladformaat: A3

Schaal: 1 : 50

Datum: 21-04-2026

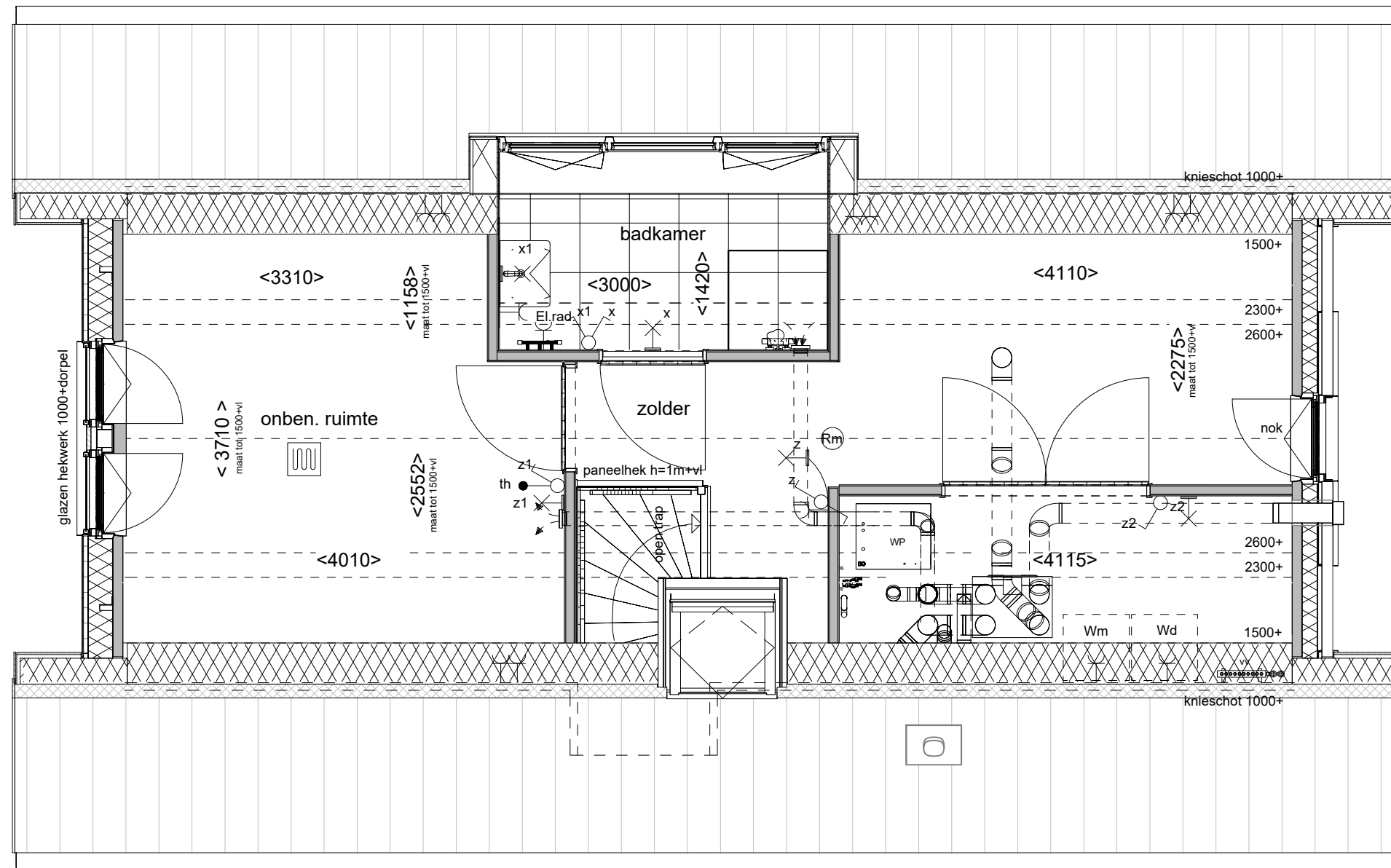

**Wonen aan
de Gantel**

Indeling met 1 onb.
ruimte + badkamer

Tekening:

Woningtype: F60-2

Bouwnummer: 22 t/m 30

Optienummer: 1.C.F.74B

Bladformaat: A3

Schaal: 1:50

Datum: 21-04-2026

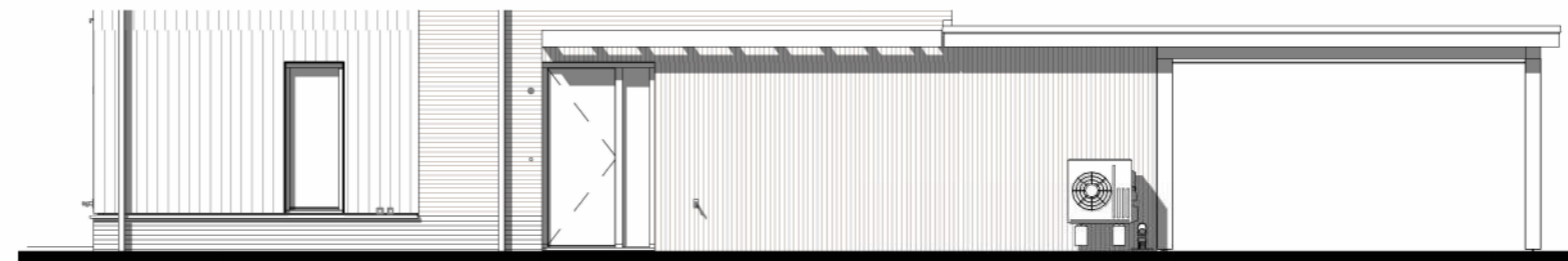
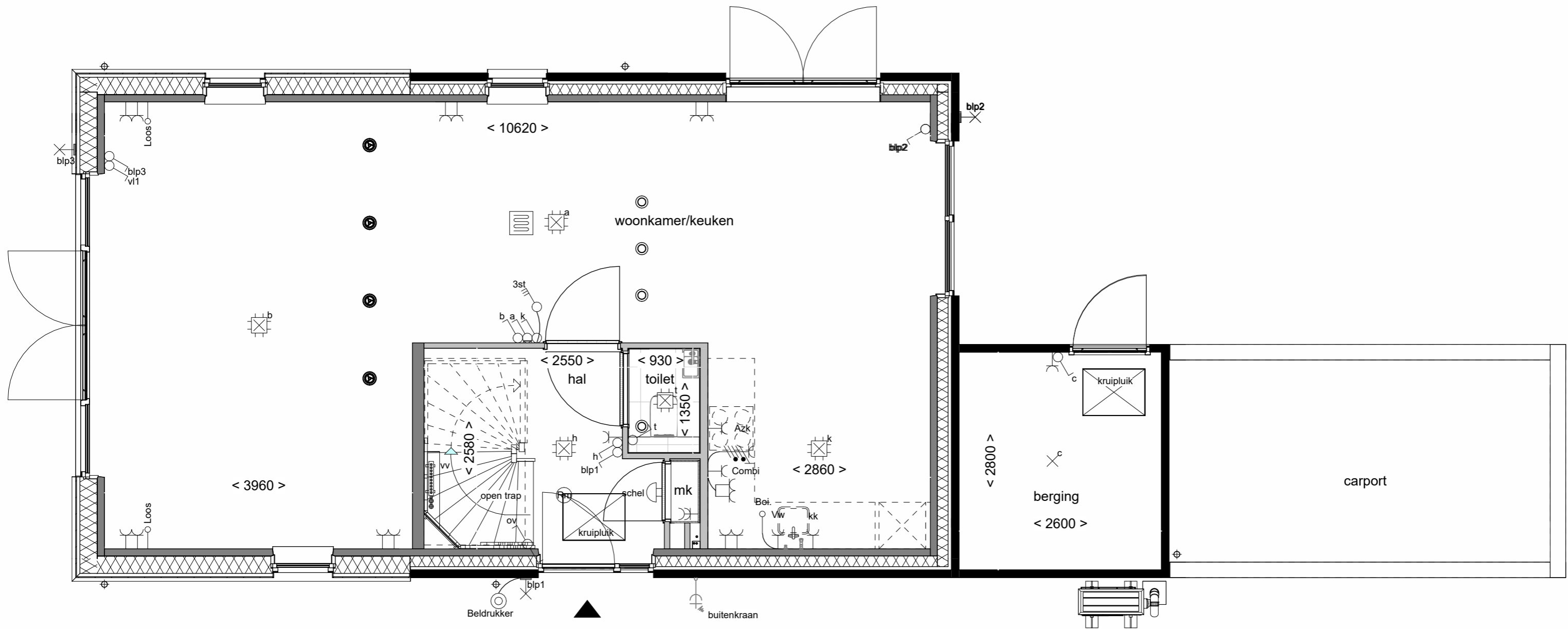

Linkerzijgevel schaal 1:100



vorstvrij buitenkraan
naast voordeur

Tekening:	
Woningtype:	F60-2
Bouwnummer:	21 t/m 31
Optienummer:	2.K.0.40
Bladformaat:	A3
Schaal:	1:50 / 1:100
Datum:	21-04-2026

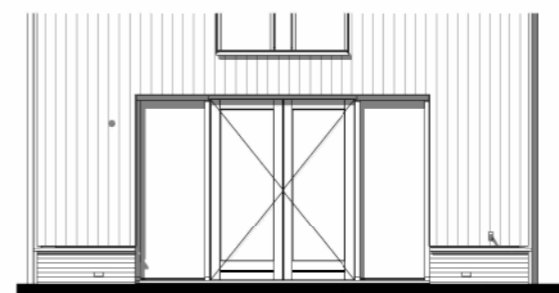
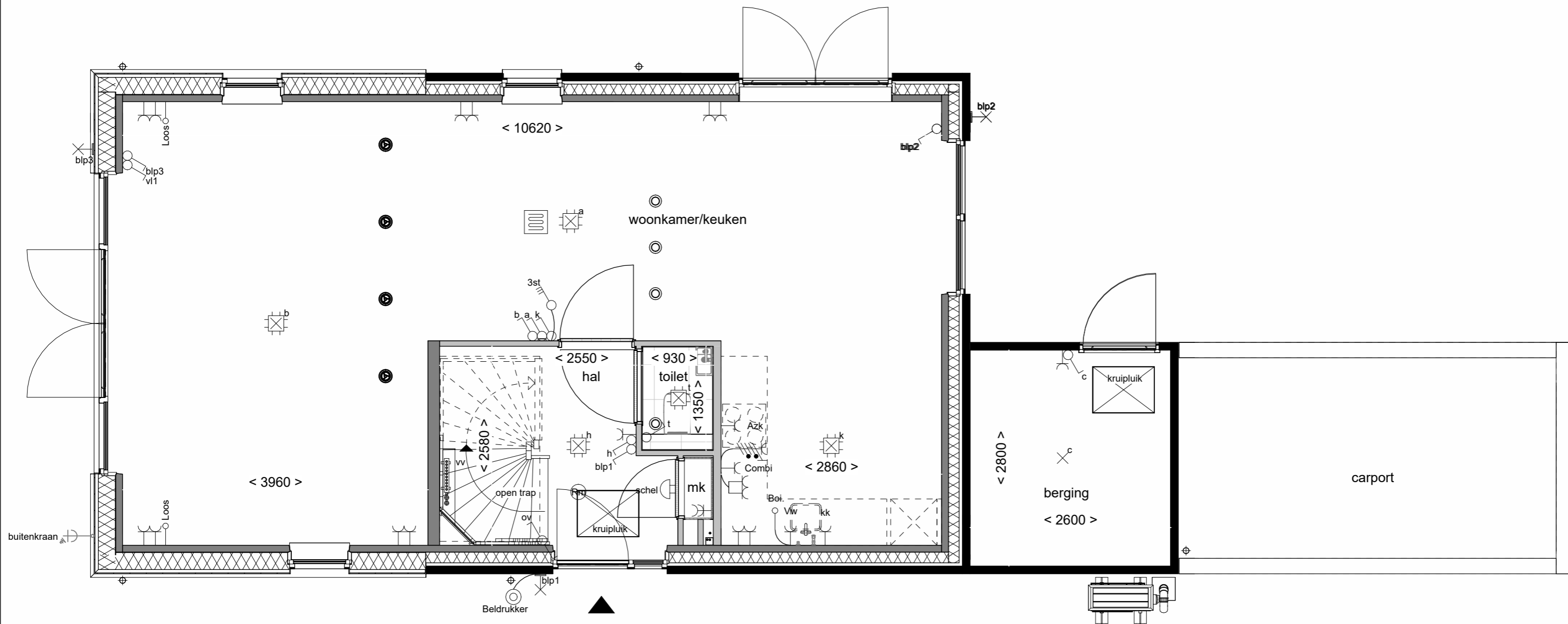

Achtergevel schaal 1:100



vorstvrije
buitenkraan achter

Tekening: vorstvrije buitenkraan achter

Woningtype: F60-2

Bouwnummer: 21 t/m 31

Optienummer: 2.K.0.44

Bladformaat: A3

Schaal: 1:50 / 1:100

Datum: 21-04-2026