

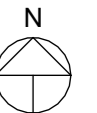

### Renvooi

-  - entree woongebouw
-  - erfgrans
-  - parkeervak eigen terrein
-  - parkeervak openbaar
-  - houten vlonder
-  - pergola
-  - haag laag
-  - haag hoog
-  - water
-  - openbaar groen
-  - wandelpad houtsnippers
-  - voetpad
-  - inrit
-  - straat
-  - talud
-  - boom, positie in overleg met koper
-  - indicatie positie riolering
-  - zone erfdienstbaarheid
-  - klinkerbestrating

### parkeerplekken en posities bomen indicatief



Tekening: **Situatie totaal**

---

Woningtype: **E60,E60D,F60,F60+**

---

Bouwnummer: **1 t/m 31**

---

Bladnummer: **VT-S-00**

---

Bladformaat: **A3**

---

Schaal: **1:750**

---

Datum: **21-04-2026**



### Renvooi

-  - entree woongebouw
-  - erfgrans
-  - parkeervak eigen terrein
-  - parkeervak openbaar
-  - houten vlonder
-  - pergola
-  - haag laag
-  - haag hoog
-  - water
-  - openbaar groen
-  - wandelpad houtsnippers
-  - voetpad
-  - inrit
-  - straat
-  - talud
-  - boom, positie in overleg met koper
-  - indicatie positie riolering
-  - zone erfdienstbaarheid
-  - klinkerbestrating

### parkeerplekken en posities bomen indicatief

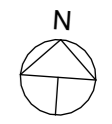

Tekening: **Situatie bnr. 16-19**

Woningtype: **E60, E60D, F60+**

Bouwnummer: **16, 17, 18, 19**

Bladnummer: **VT-S-05**

Bladformaat: **A3**









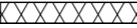

Schaal: **1:200**

Datum: **21-04-2026**

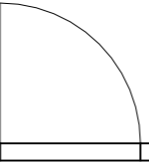
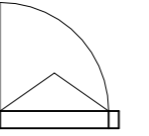
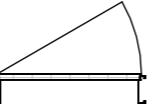
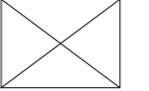



















## Renvooi materialen

	dakpan antracietgrijs
	metselwerk kleur grijswit gesinterd code A: EN1166 WF WS
	metselwerk kleur bruin nuance code B: HM1106 WF WS
	metselwerk kleur bruin caramel code C: EN1165 WF WS
	gevelbetimmering vuren vergrijsd

## Renvooi bouwkundig

	entree woning
	metselwerk
	isolatie
	dragende wand
	niet dragende binnenwand
	buitendeur
	draairaam
	binnendeurkozijn (met bovenlicht)
	kruipluik
	opstelplaats wasmachine
	opstelplaats wasdroger
	opstelplaats koelkast
	principe opstelling keukenblok
	onbenoemde ruimte volgens krijtstreepmethode

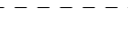
## Renvooi installaties

	aansluitpunt licht, wand
	centraaldoos met lichtpunt
	armatuur aan de wand
	rookmelder
	aansluitpunt niet bedraad / loos
	aansluitpunt bedraad data, niet afgemonteerd
	beldrukker
	schel
	schakelaar, 1-polig
	werkschakelaar tbv PV-panelen
	driestandenschakelaar tbv wtw
	schakelaar, wissel
	schakelaar, serie
	pulsschakelaar tbv warmteterugwinunit
	wandcontactdoos 1-voudig met beschermingscontact
	wandcontactdoos 2-voudig met beschermingscontact
	thermostaatleiding, bedraad
	wandcontactdoos tbv warmteterugwinunit
	wtw mechanische ventilatie-unit incl. warmteterugwinunit
	wp warmtepomp
	inblaasventiel mechanische ventilatie
	afzuigventiel mechanische ventilatie
	vv verdeler vloerverwarming
	ruimte vzv vloerverwarming
	rad elektrische radiator
	kanalen in het zicht
	doucheput
	lijngoot douche
	buitenkraan

### Disclaimer

De op deze tekeningen aangegeven maten zijn circa maten in millimeters en tussen de wanden / vloeren gemeten, waarbij geen rekening is gehouden met enige wandafwerking, plinten, aftimmering, etc. In verband met de nauwkeurige uitwerking van details, constructie, maatvoering, materialen e.d. kunnen er kleine afwijkingen ontstaan ten opzichte van de nu vermelde gegevens. Deze geringe afwijkingen geven geen aanleiding tot verrekening. Aan de op deze tekening aangegeven maten kunnen derhalve geen rechten worden ontleend. De op deze tekeningen aangegeven maatvoering is niet geschikt voor opdrachten aan derden door koper(s). De posities van aansluitingen en installatie onderdelen zijn indicatief op tekening aangegeven. De exacte aantallen en posities zullen na berekening in het werk door de installateurs worden bepaald en kunnen afwijken van deze tekening.



Tekening:	Renvooi
Woningtype:	E60 / F60 / F60+
Bouwnummer:	1 t/m 31
Bladnummer:	VT-0-00c
Bladformaat:	A3
Schaal:	1 : 50
Datum:	21-04-2026



Voorgevel

Type: F60+  
bnr: 18



Doorsnede



Achtergevel

Type: F60+  
bnr: 18



Tekening: Gevel/Drsn Blok 12

Woningtype: F60+

Bouwnummer: 18

Bladnummer: VT-12-00a

Bladformaat: A3

Schaal: 1 : 100

Datum: 21-04-2026



Linker zijgevel

Type: F60+  
bnr: 18



Rechter zijgevel

Type: F60+  
bnr: 18



Tekening: Zijgevels blok 12

Woningtype: F60+

Bouwnummer: 18

Bladnummer: VT-12-00b

Bladformaat: A3

Schaal: 1 : 100

Datum: 21-04-2026

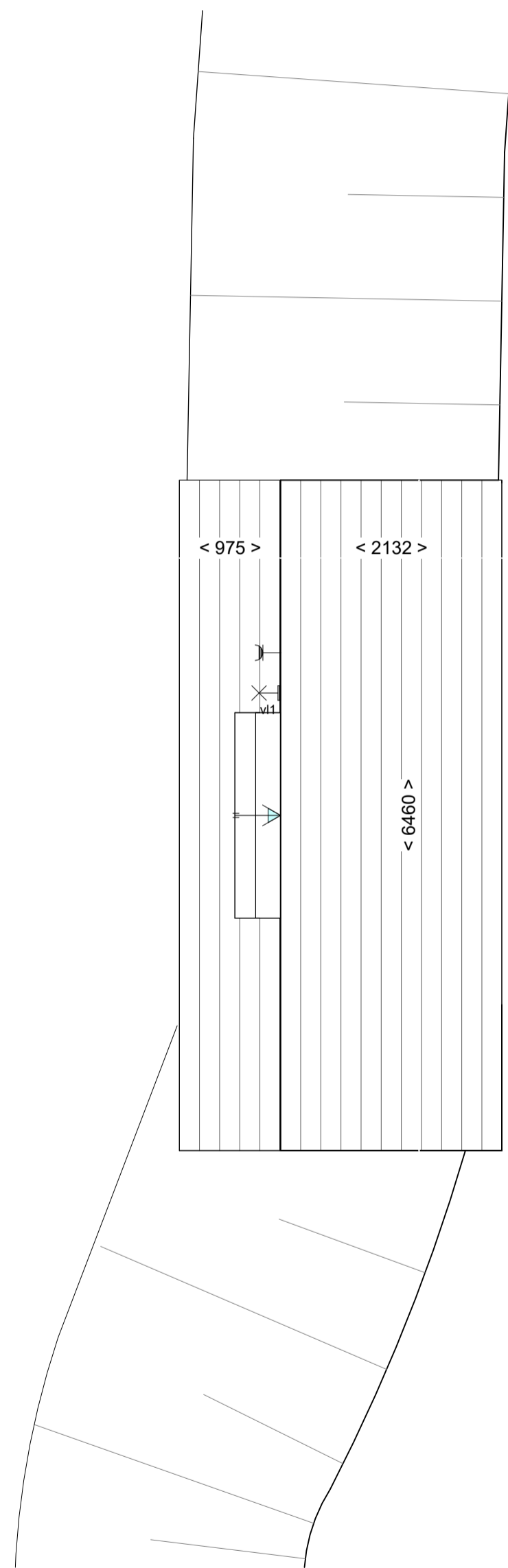

< ca. 5940 >

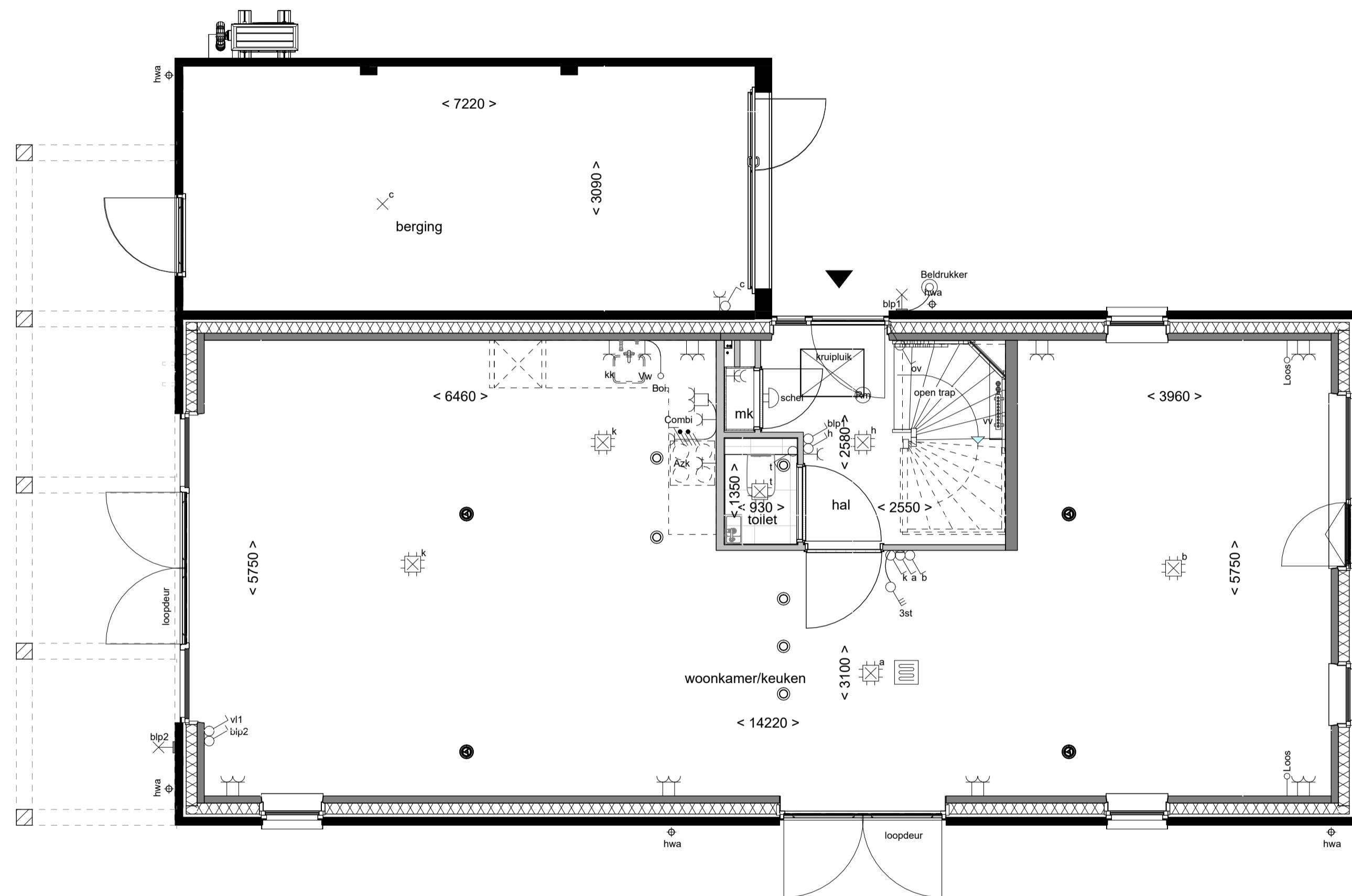

Tekening: Begane grond

Woningtype: F60+

Bouwnummer: 18

Bladnummer: VT-12-18a

Bladformaat: A2

Schaal: 1 : 50

Datum: 21-04-2026

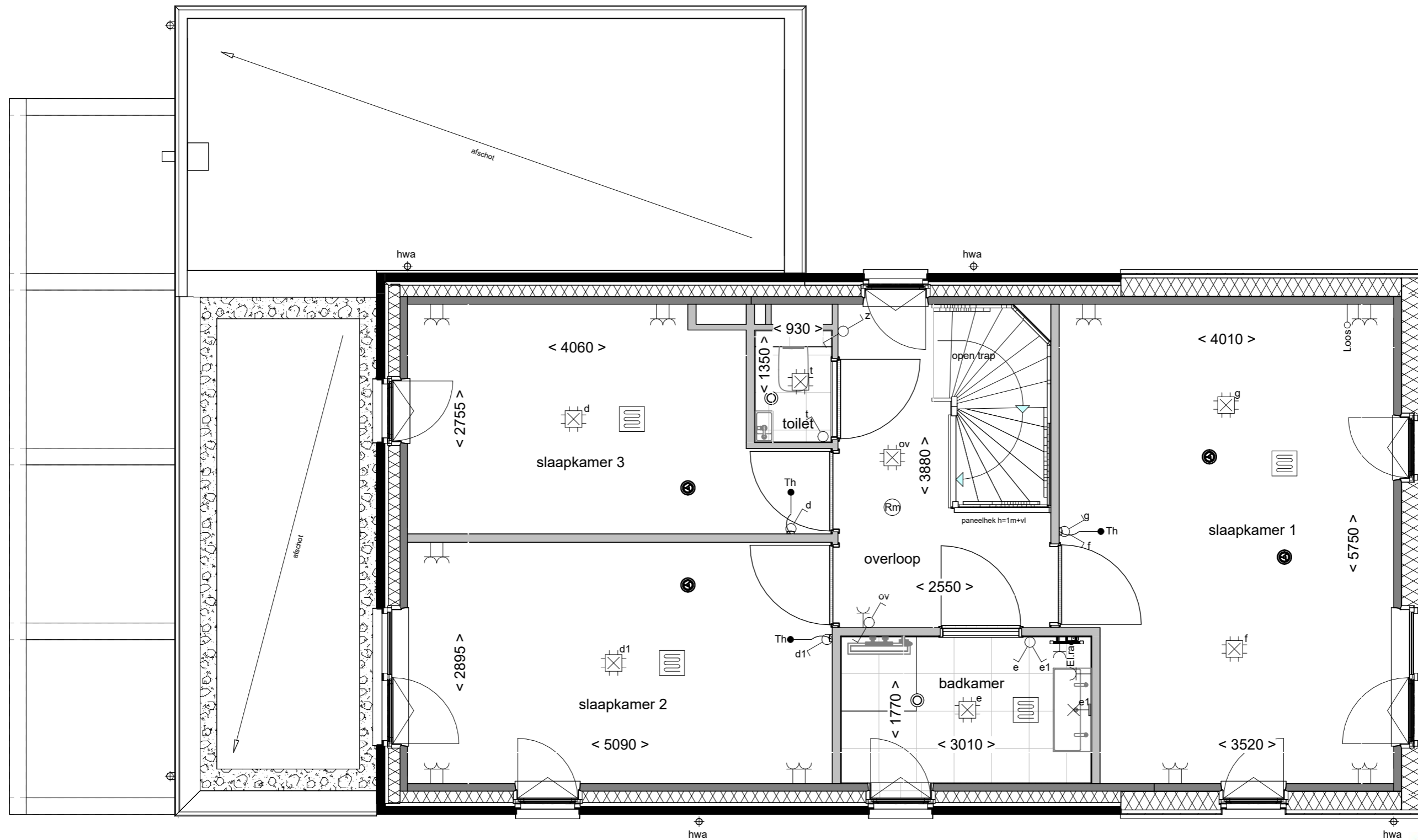

Tekening: **Eerste verdieping**

Woningtype: **F60+**

Bouwnummer: **18**

Bladnummer: **VT-12-18b**

Bladformaat: **A3**

Schaal: **1 : 50**

Datum: **21-04-2026**

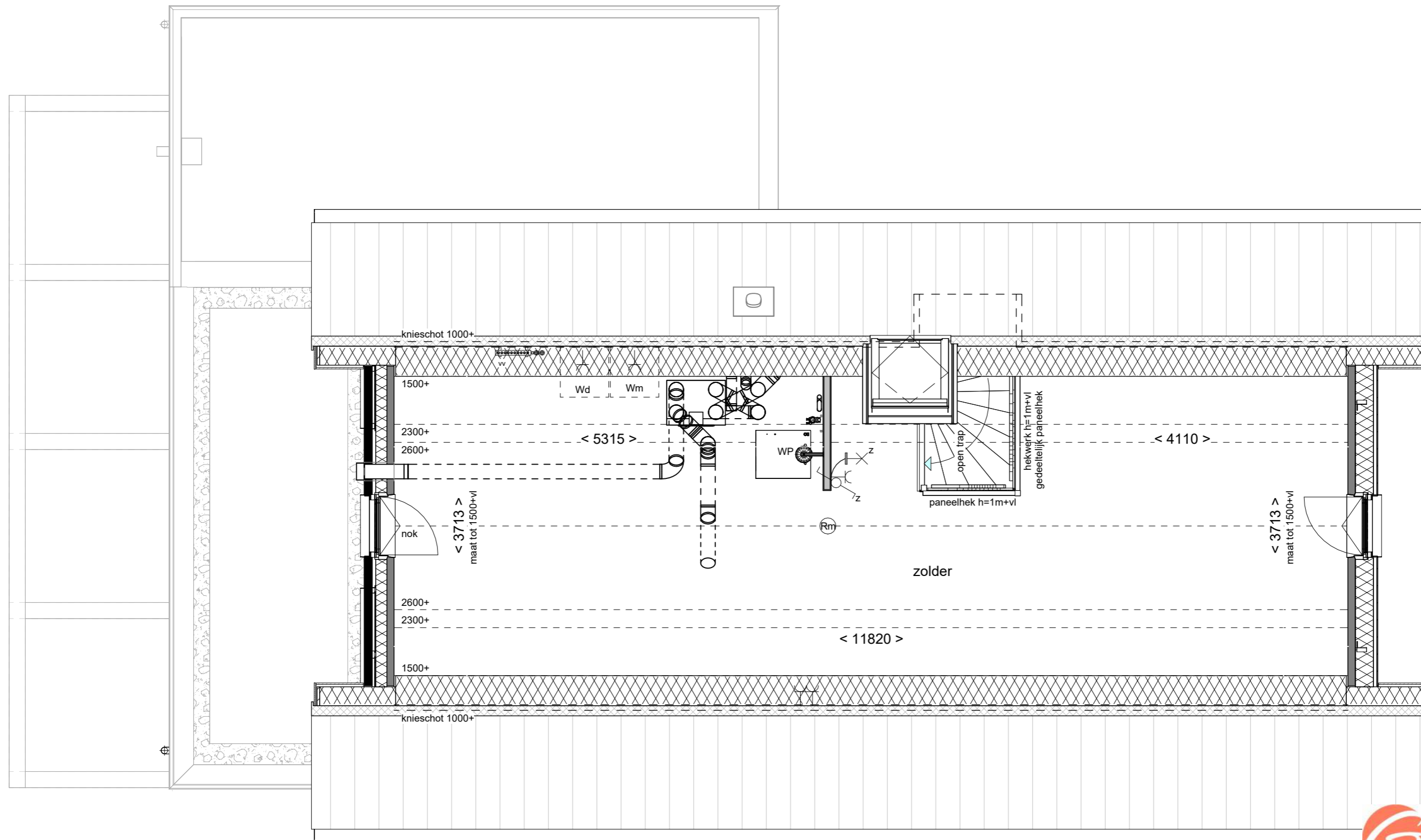

**Wonen aan  
de Gantel**

Tekening: **Tweede verdieping**

Woningtype: **F60+**

Bouwnummer: **18**

Bladnummer: **VT-12-18c**

Bladformaat: **A3**

Schaal: **1 : 50**

Datum: **21-04-2026**

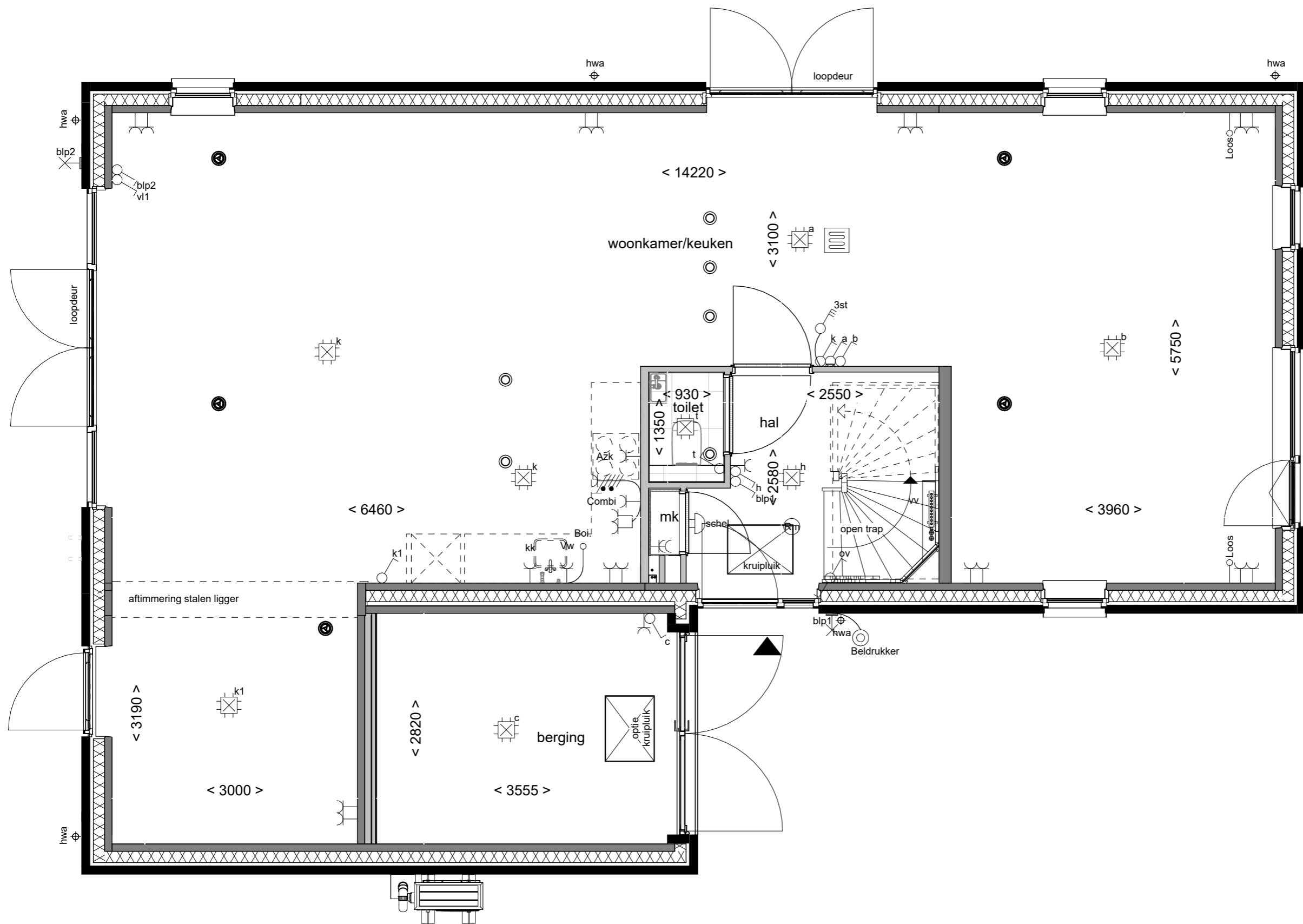

**Samenvoegen  
berging bij wnk**

Tekening:	
Woningtype:	F60+
Bouwnummer:	8/9/14/15/18/19
Optienummer:	1.A.F.15
Bladformaat:	A3
Schaal:	1 : 50
Datum:	21-04-2026

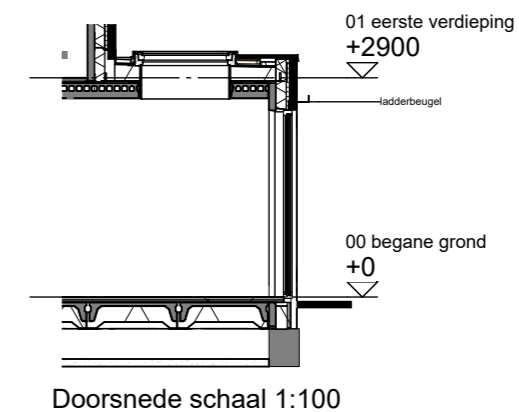
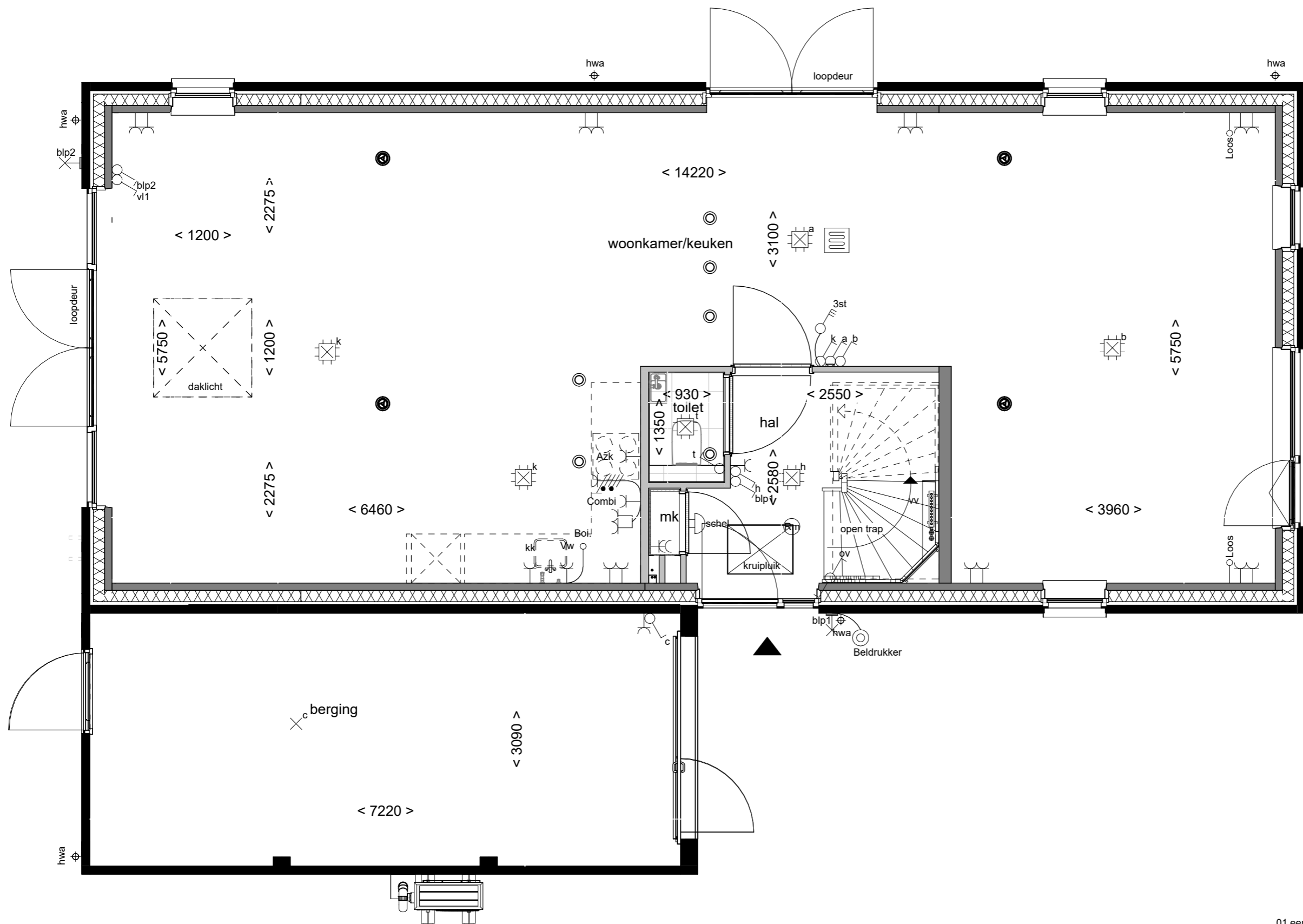

Lichtkoepel in  
uitbouw 240cm

Tekening: **Lichtkoepel in uitbouw 240cm**  
 Woningtype: **F60+**  
 Bouwnummer: **8/9/14/15/18/19**  
 Optienummer: **1.B.X.10**  
 Bladformaat: **A3**  
 Schaal: **1:50 / 1:100**  
 Datum: **21-04-2026**

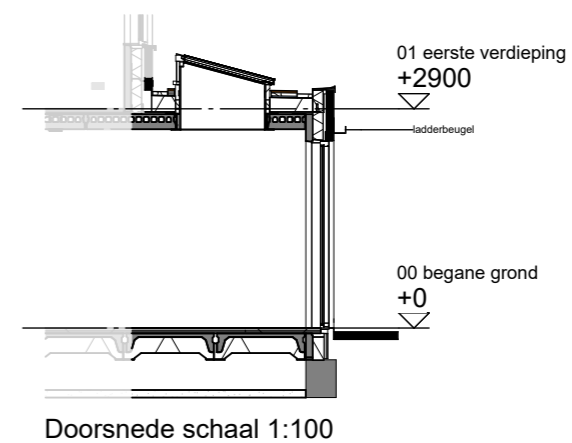
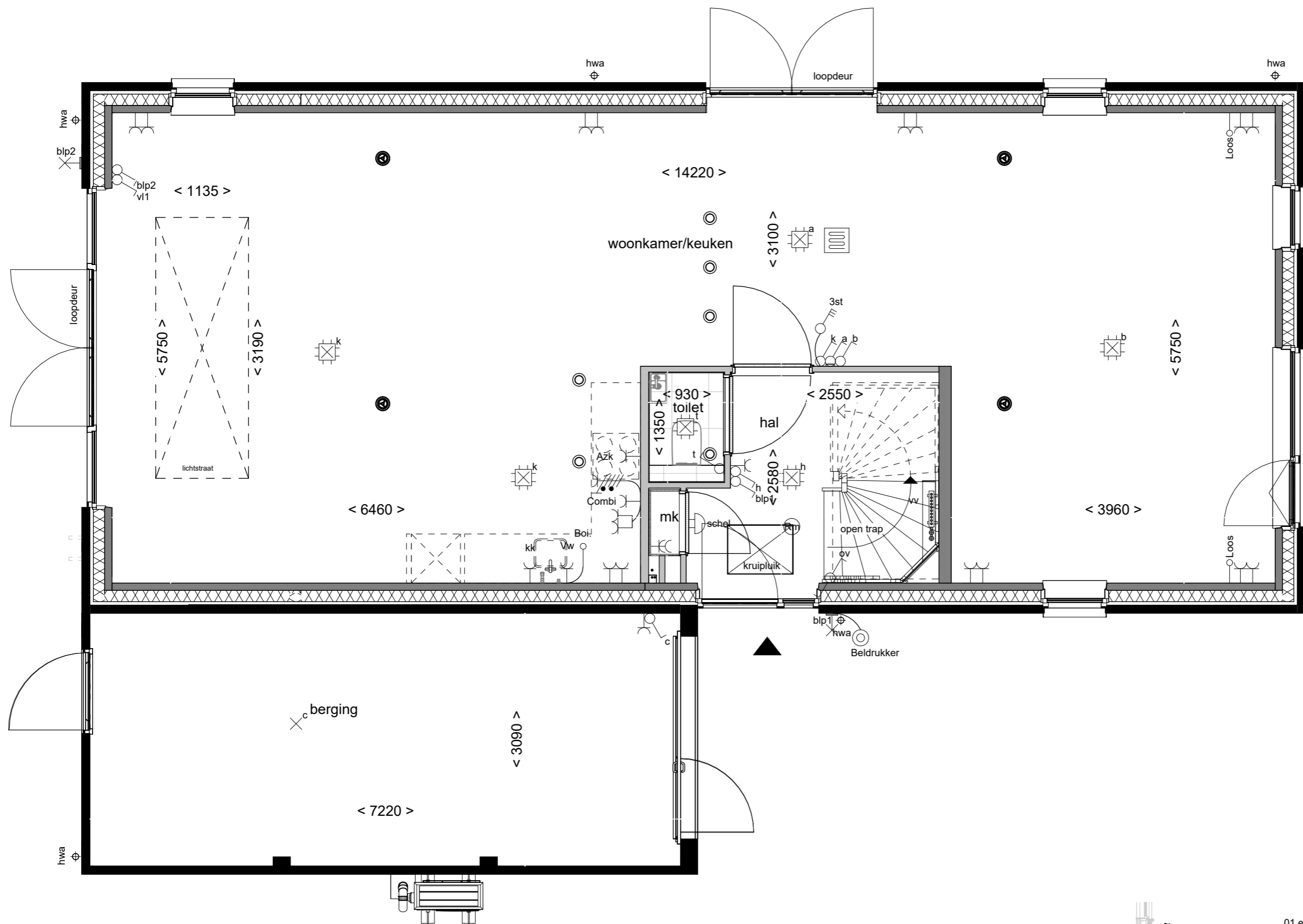

Lichtstraat in uitbouw 240cm

Tekening:

Woningtype: F60+

Bouwnummer: 8/9/14/15/18/19

Optienummer: 1.B.X.14

Bladformaat: A3

Schaal: 1:50 / 1:100

Datum: 21-04-2026

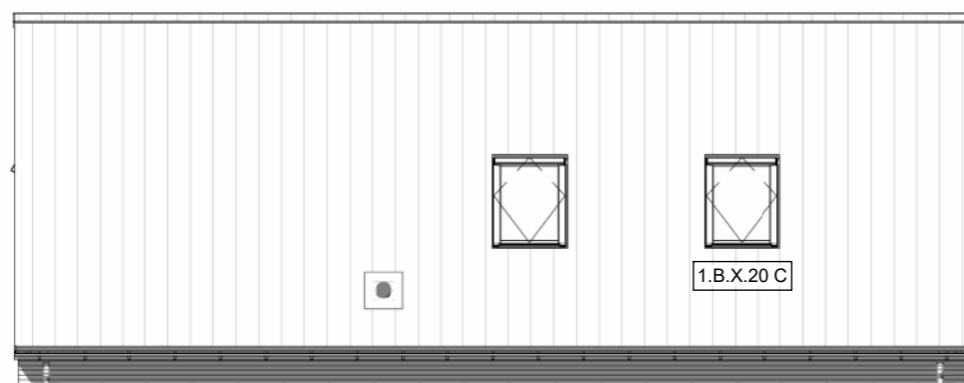
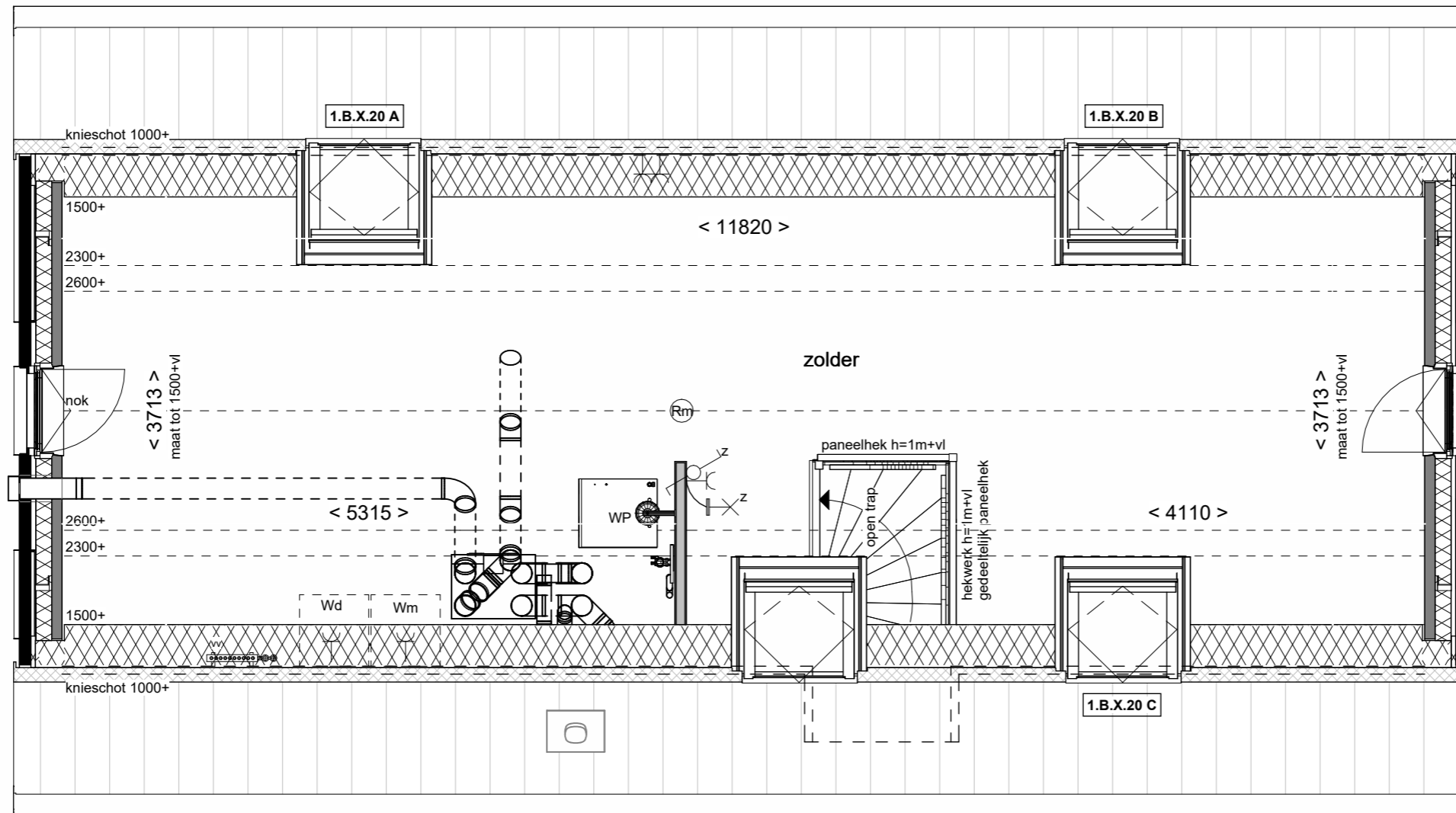

Linkerzijgevel schaal 1:100

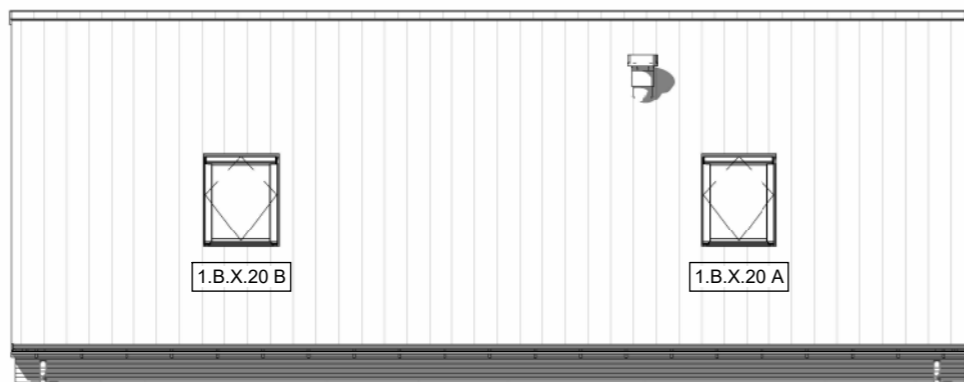

Rechterzijgevel schaal 1:100

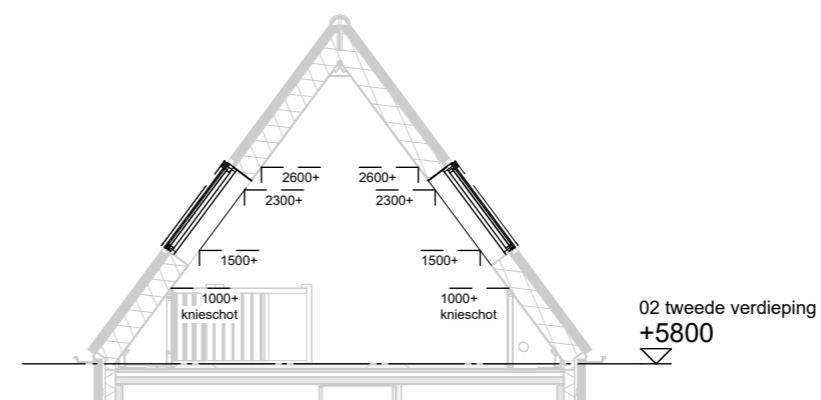

Doorsnede schaal 1:100



Tekening: Dakramen zijgevels

Woningtype: F60+

Bouwnummer: 8/9/14/15/18/19/20

Optienummer: 1.B.X.20

Bladformaat: A3

Schaal: 1:50 / 1:100

Datum: 21-04-2026

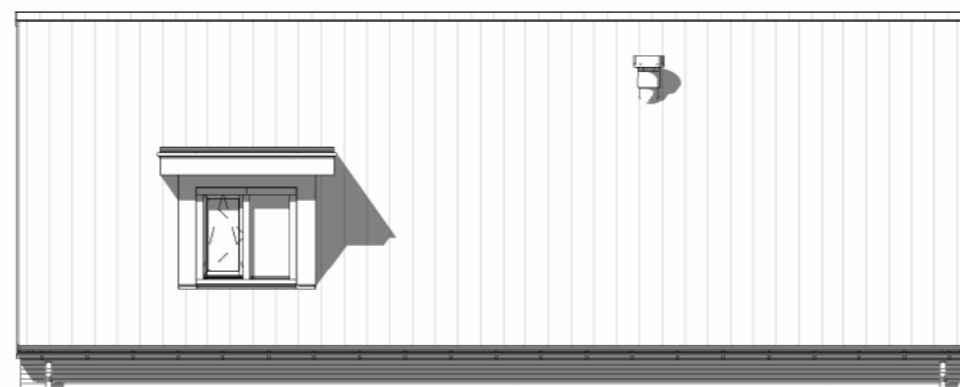
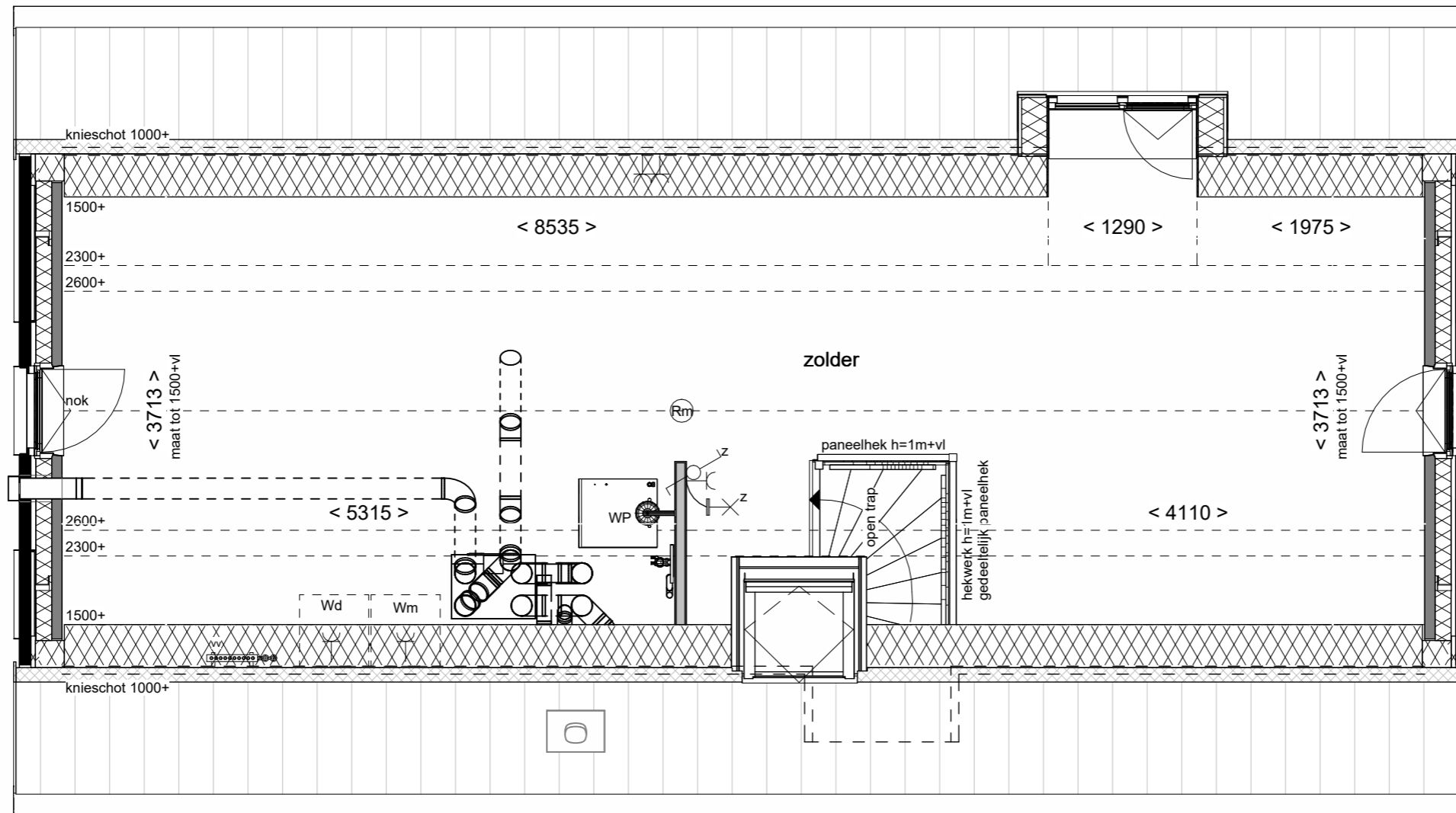

Rechterzijgevel schaal 1:100

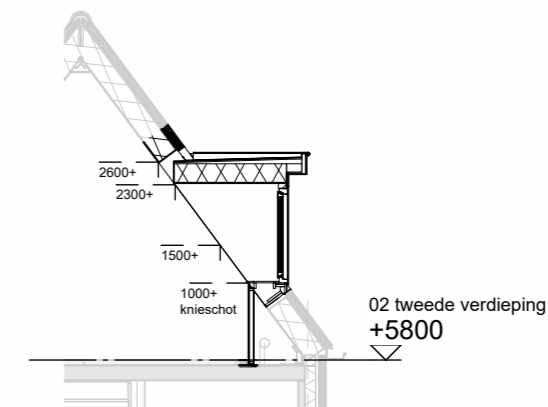

Doorsnede schaal 1:100



Dakkapel zijgevel  
130cm

Tekening:

Woningtype: F60+

Bouwnummer: 14/15/18/19/20

Optienummer: 1.B.X.36

Bladformaat: A3

Schaal: 1:50 / 1:100

Datum: 21-04-2026

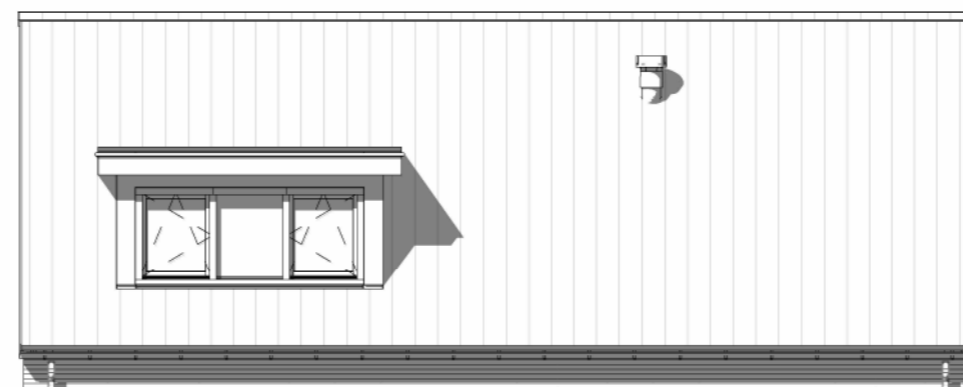
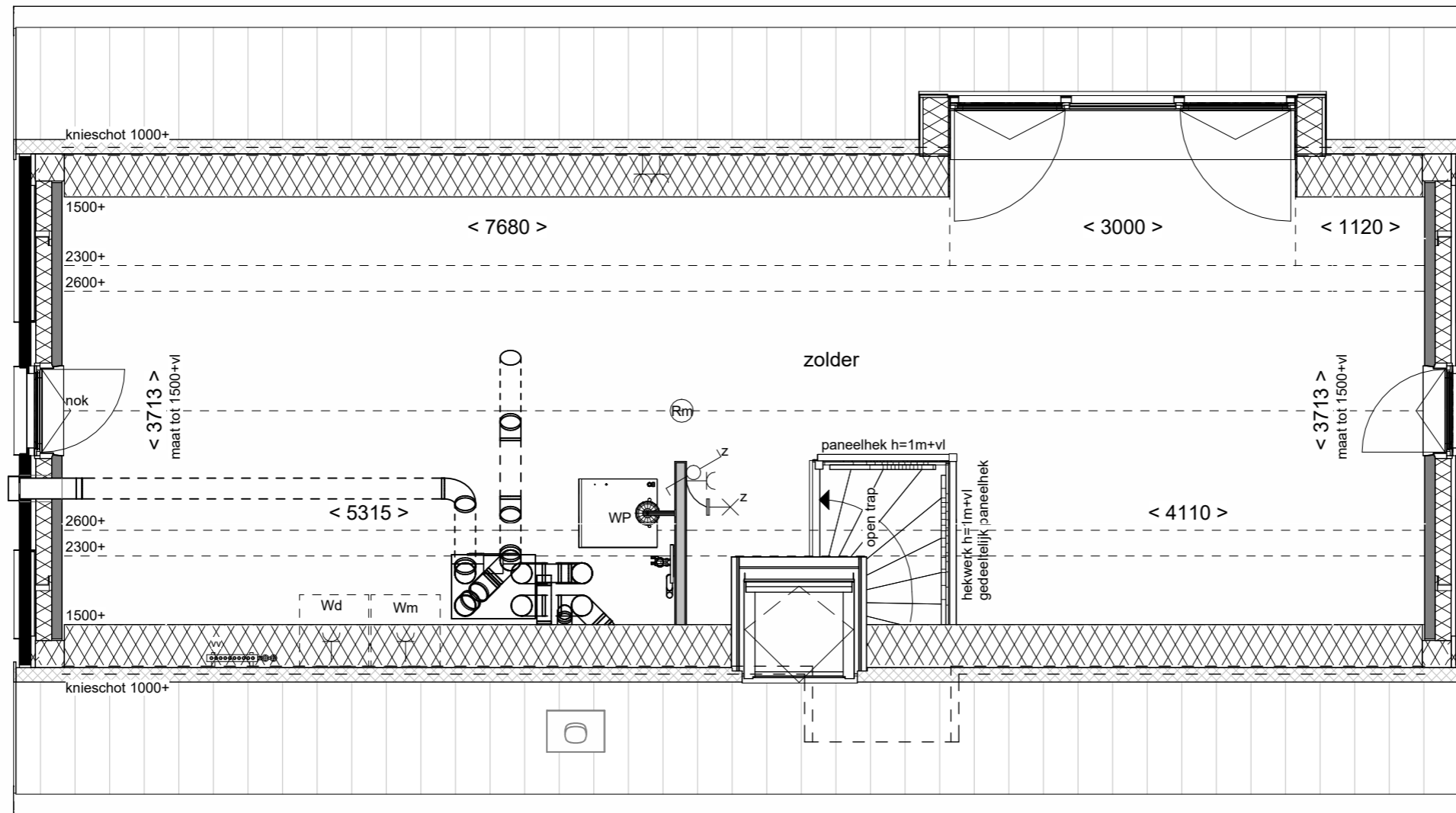

Rechterzijgevel schaal 1:100

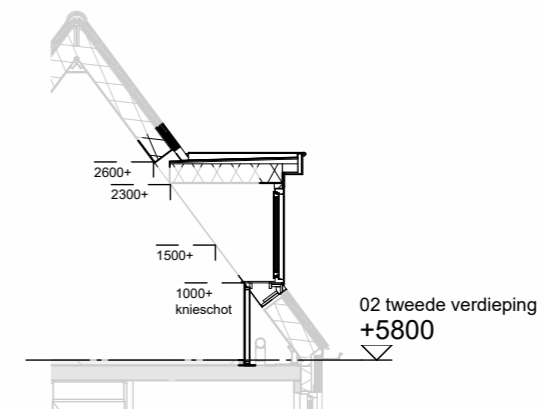

Doorsnede schaal 1:100



Dakkapel zijgevel  
300cm

Tekening:

Woningtype: F60+

Bouwnummer: 14/15/18/19/20

Optienummer: 1.B.X.38

Bladformaat: A3

Schaal: 1:50 / 1:100

Datum: 21-04-2026

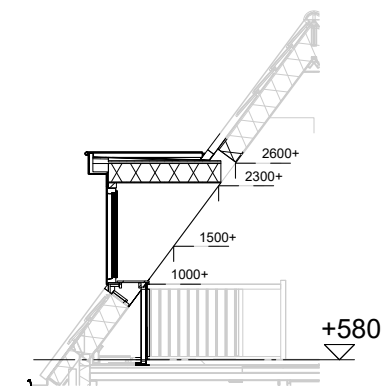
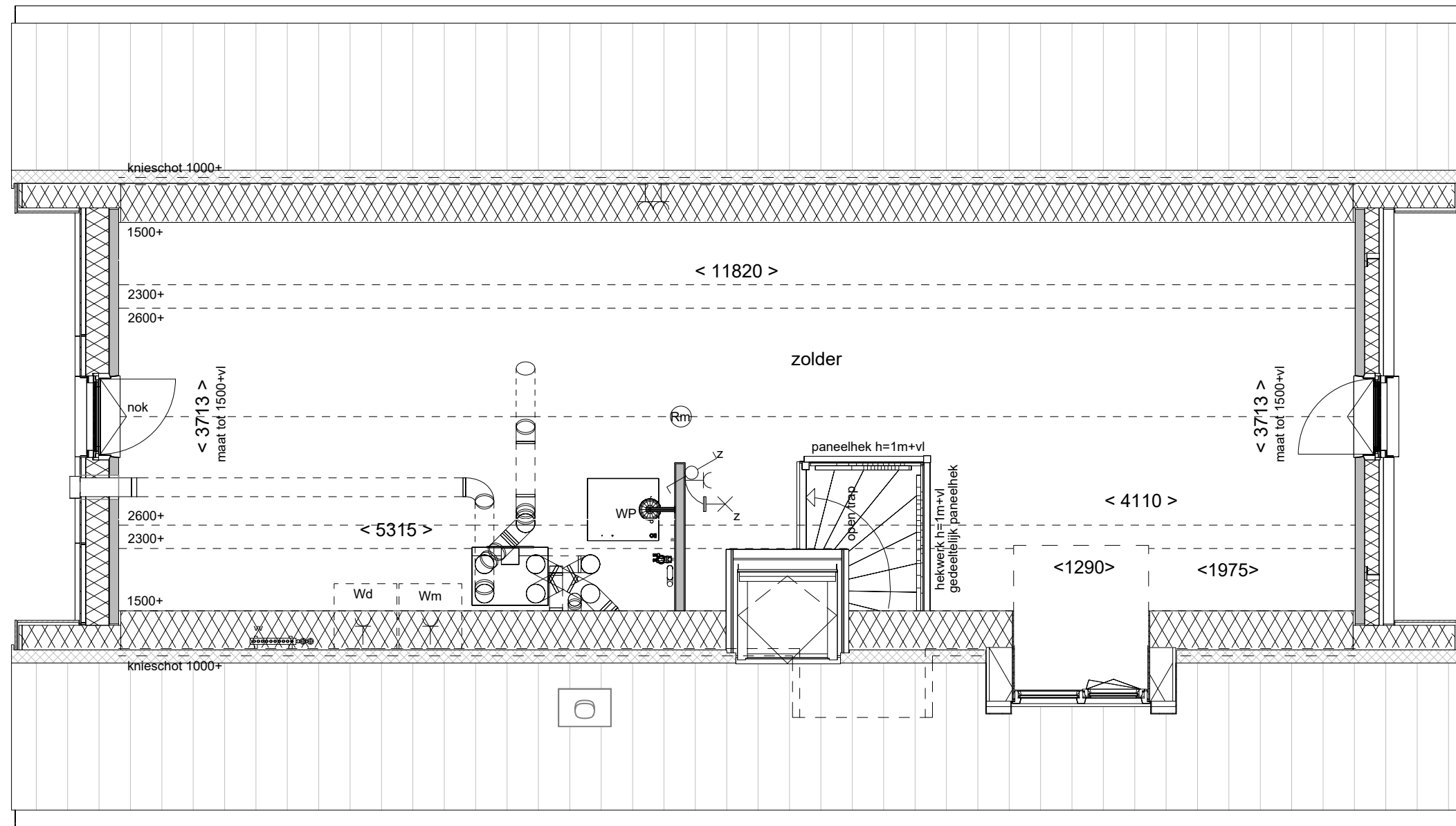

Doorsnede schaal 1:100



Dakkapel zijgevel

Tekening: 130cm

Woningtype: F60+

Bouwnummer: 8/9/14/15/18/19

Optienummer: 1.B.X.36

Bladformaat: A3

Schaal: 1:50 / 1:100

Datum: 21-04-2026





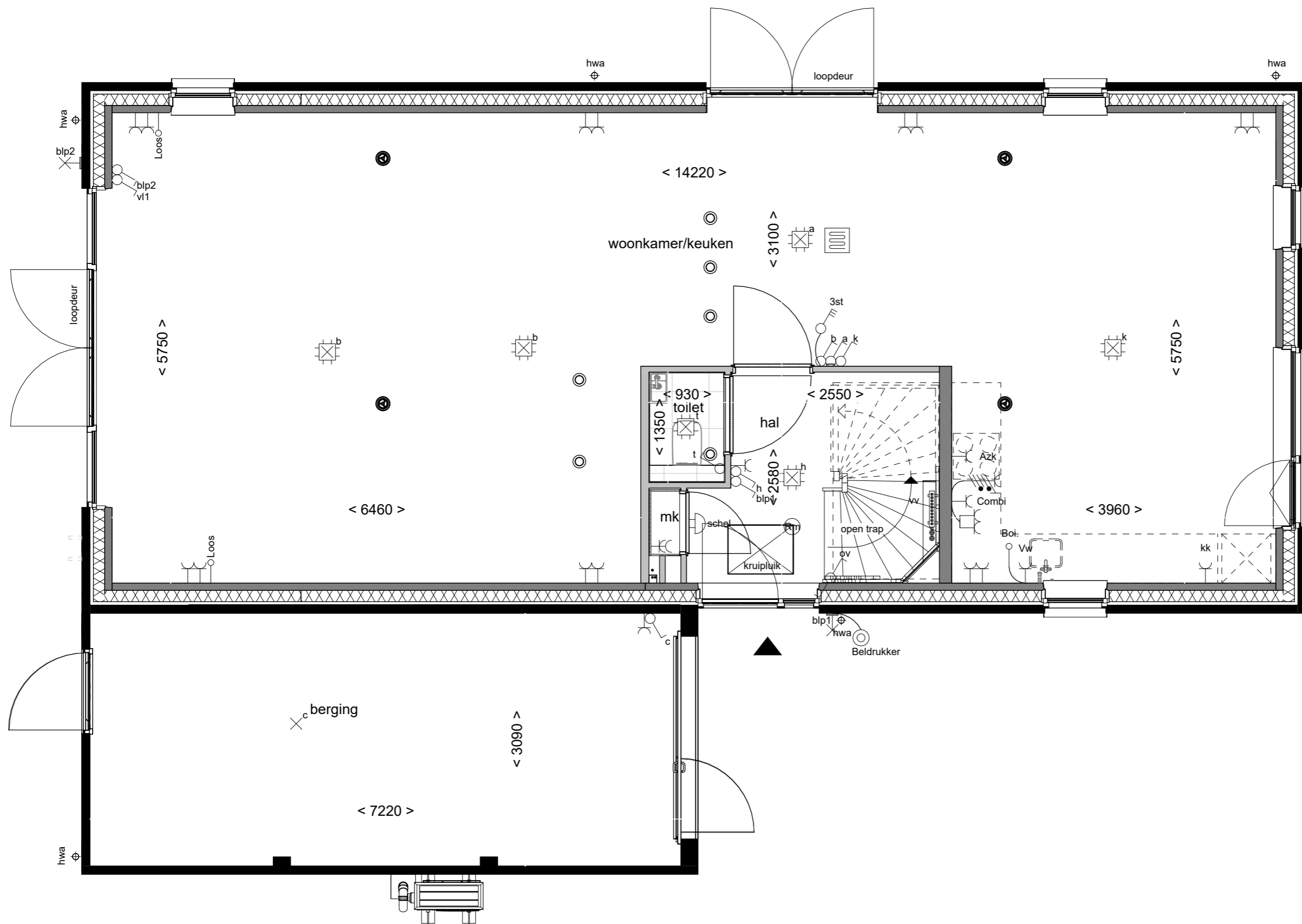

Tekening: Tuingericht wonen

Woningtype: F60+

Bouwnummer: 8/9/14/15/18/19/20

Optienummer: 1.C.F.13

Bladformaat: A3

Schaal: 1:50

Datum: 21-04-2026

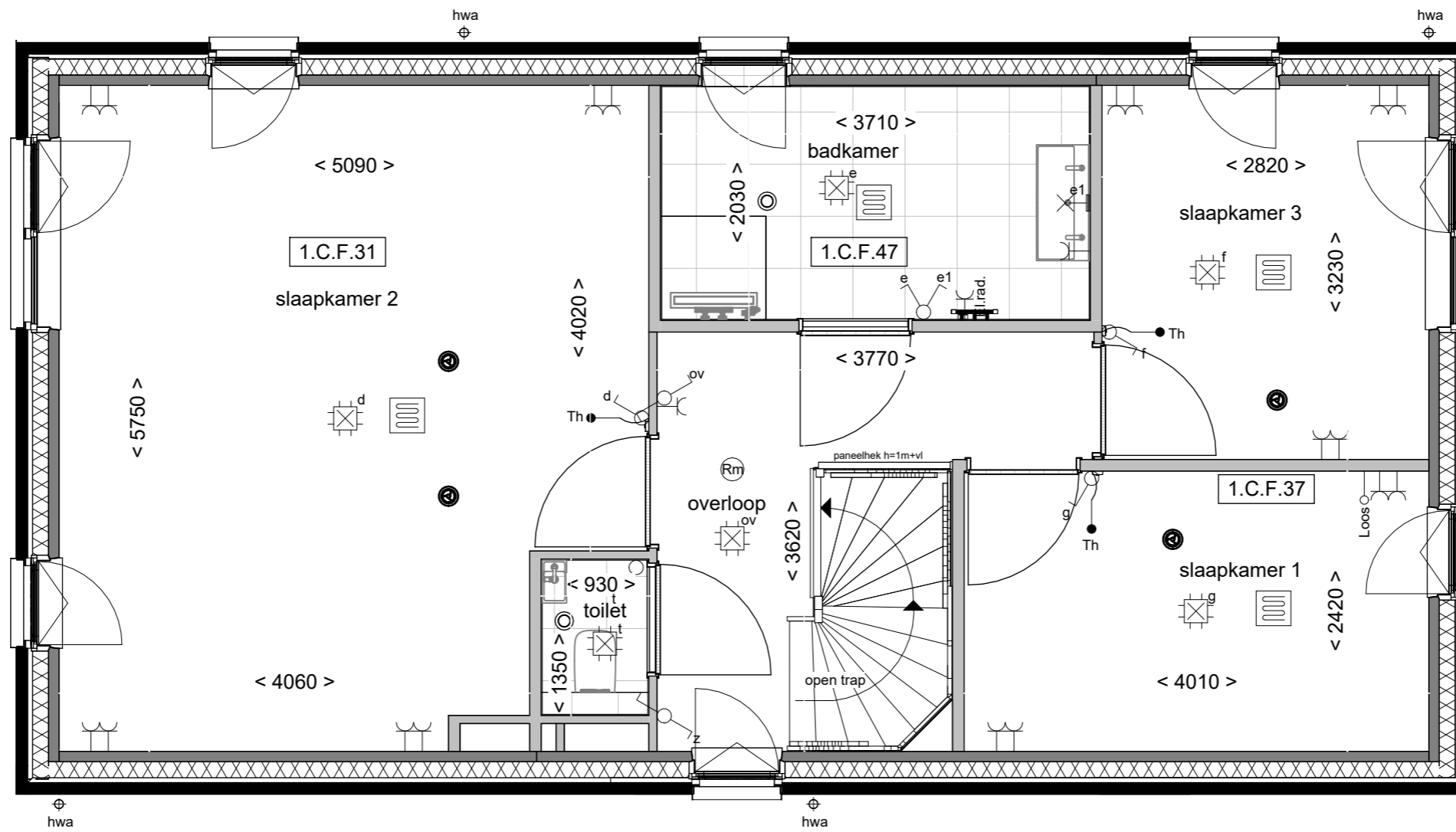

**Wonen aan de Gantel**  
 Vergroten badk.  
 indeling 2 slpk voor

Tekening:	Vergroten badk. indeling 2 slpk voor
Woningtype:	F60+
Bouwnummer:	8/9/14/15/18/19/20
Optienummer:	1.C.F.31/-37/-47
Bladformaat:	A3
Schaal:	1:50
Datum:	21-04-2026

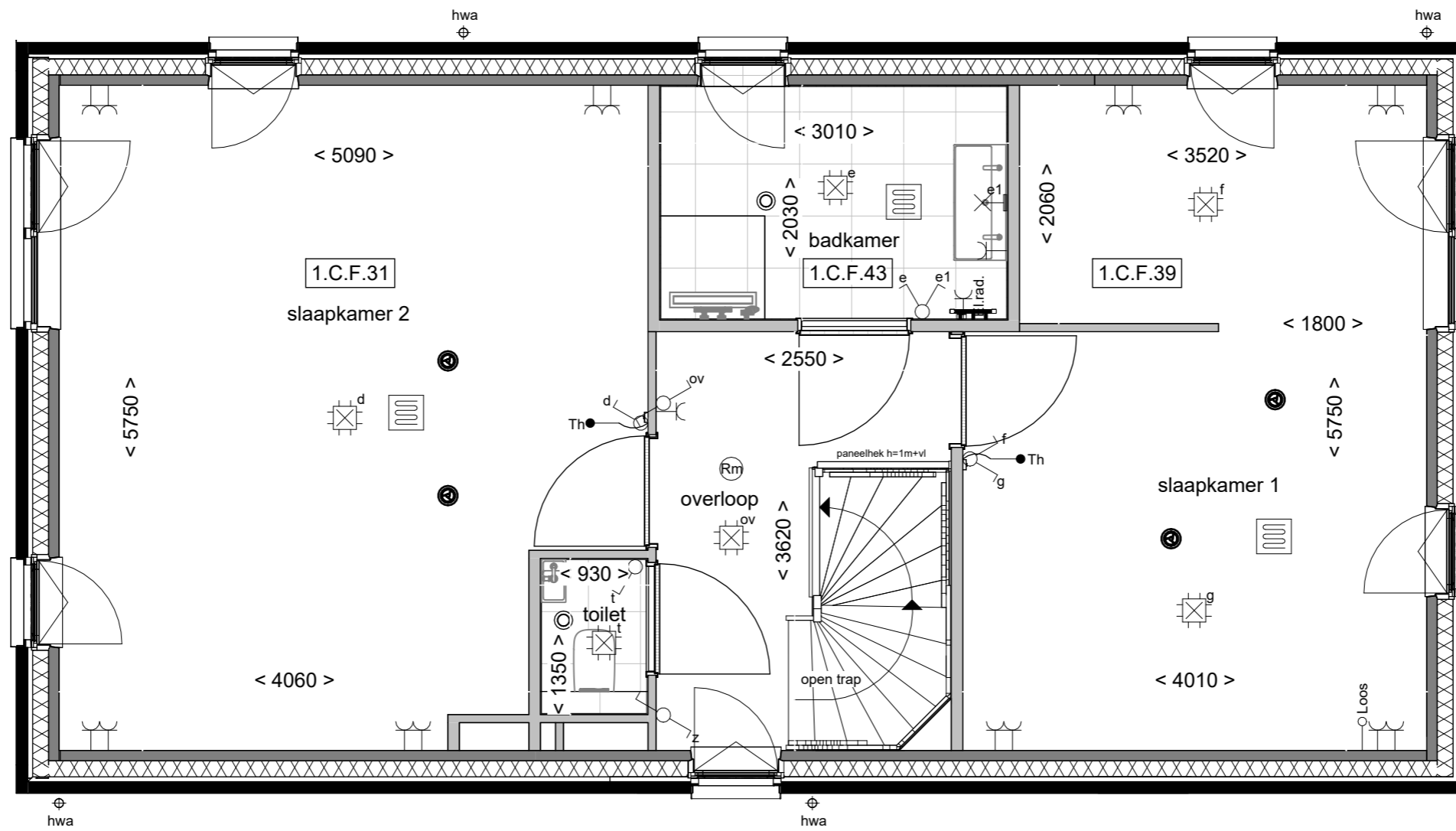

Wonen aan  
de Gantel

Tekening: Verbreden badk  
inloopk. slpk voor

Woningtype: F60+

Bouwnummer: 8/9/14/15/18/19/20

Optienummer: 1.C.F.31/-39/-43

Bladformaat: A3

Schaal: 1:50

Datum: 21-04-2026

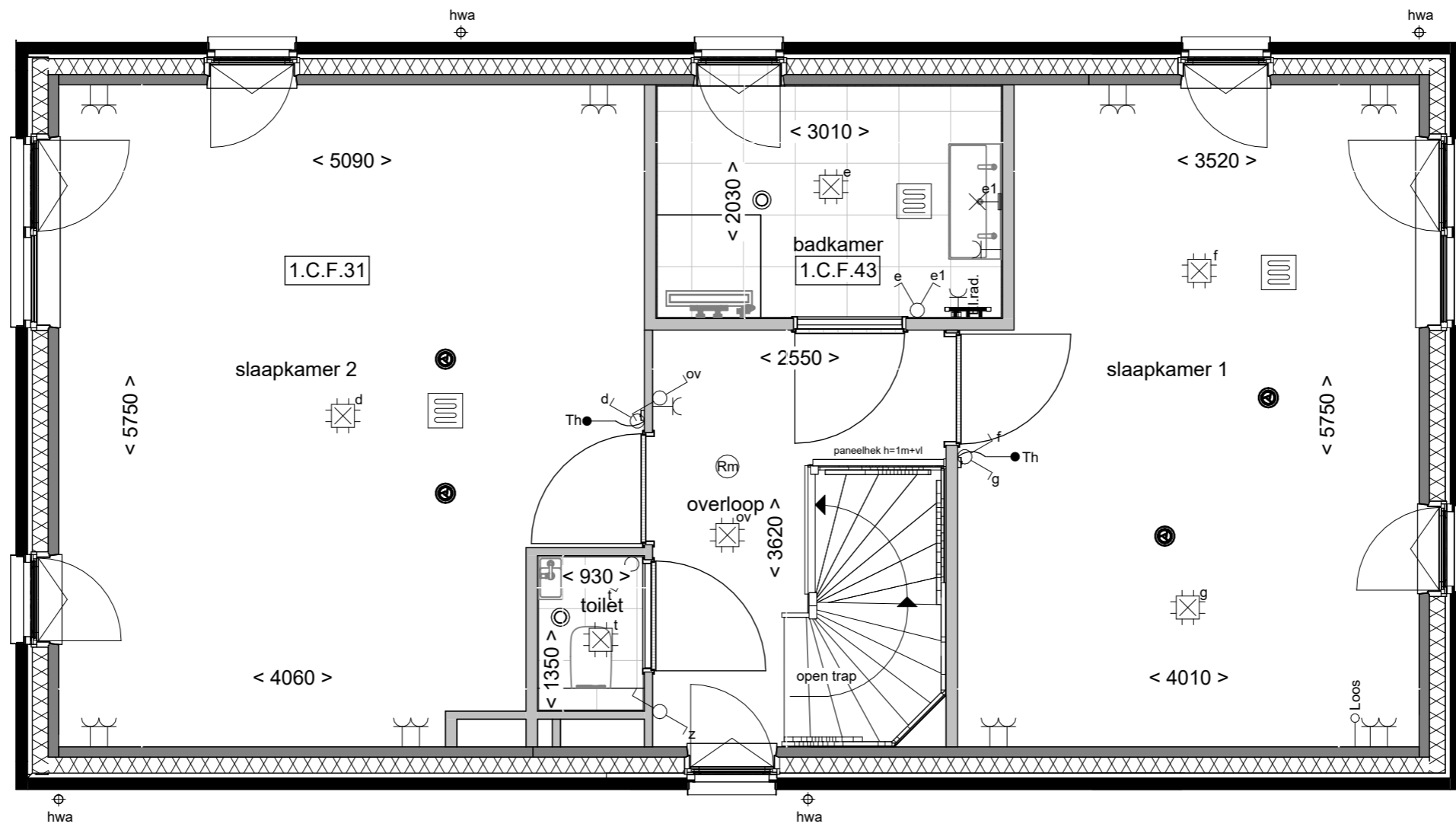

Wonen aan  
de Gantel

Tekening: Verbreden badk  
samenv.slpk achter

Woningtype: F60+

Bouwnummer: 8/9/14/15/18/19/20

Optienummer: 1.C.F.31/-43

Bladformaat: A3

Schaal: 1:50

Datum: 21-04-2026

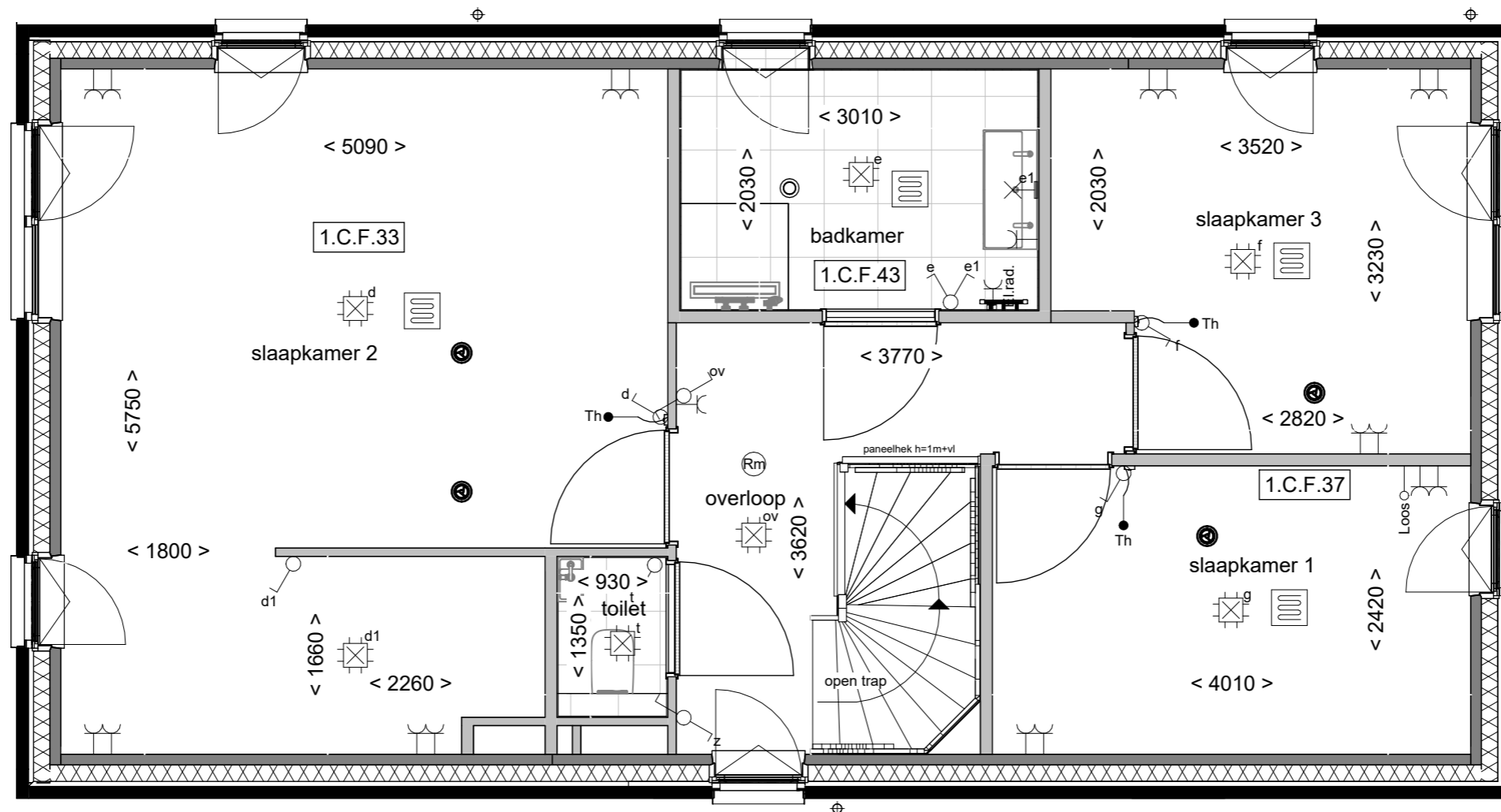

Inloopk. slpk achter  
indeling 2 slpk voor

Tekening:

Woningtype: F60+

Bouwnummer: 8/9/14/15/18/19/20

Optienummer: 1.C.F.33/-37/-43

Bladformaat: A3

Schaal: 1:50

Datum: 21-04-2026

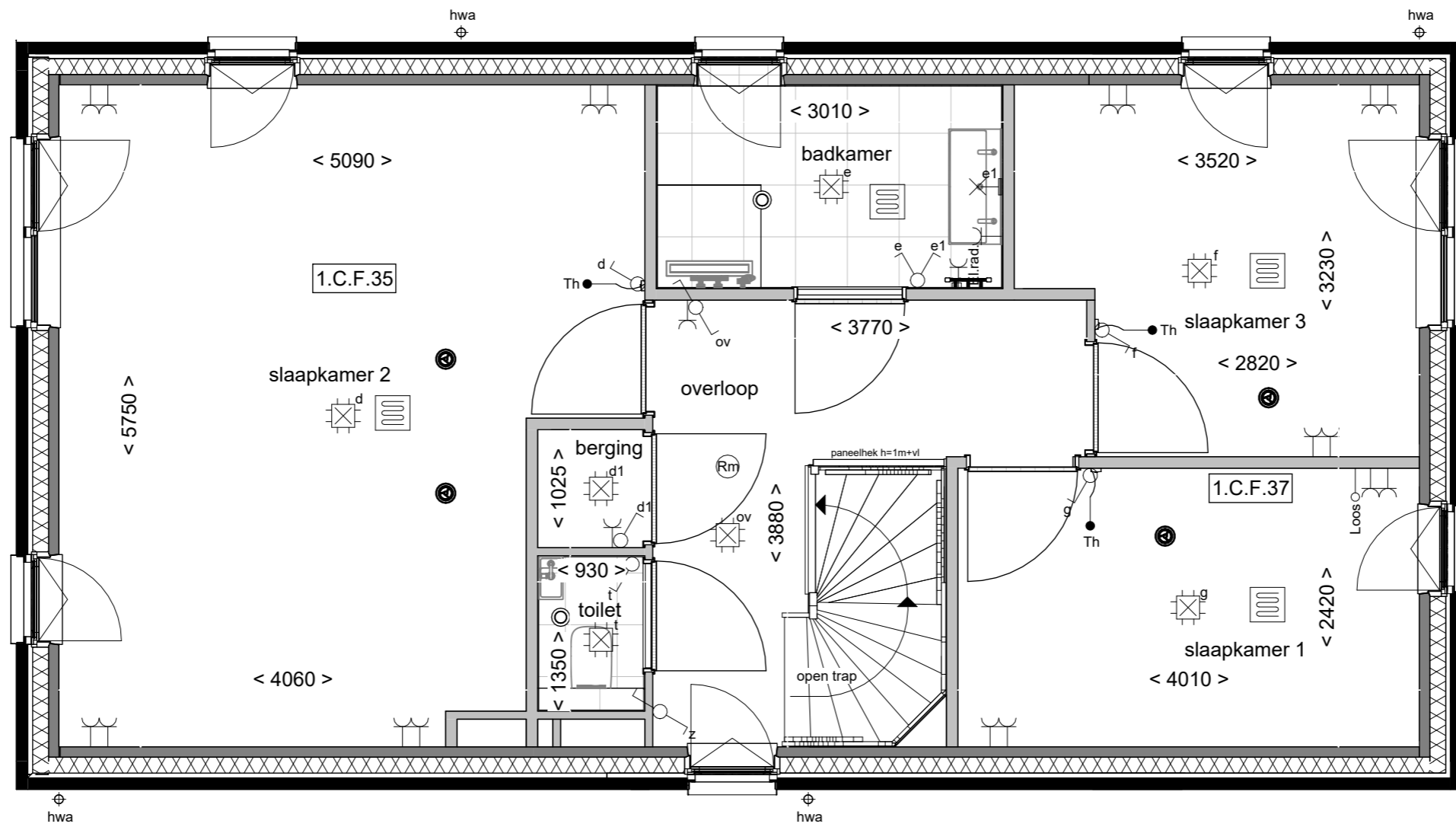

**Wonen aan  
de Gantel**

Vaste kast en 2 slpk.  
voor

Tekening: voor

Woningtype: F60+

Bouwnummer: 8/9/14/15/18/19/20

Optienummer: 1.C.F.35/-37

Bladformaat: A3

Schaal: 1:50

Datum: 21-04-2026

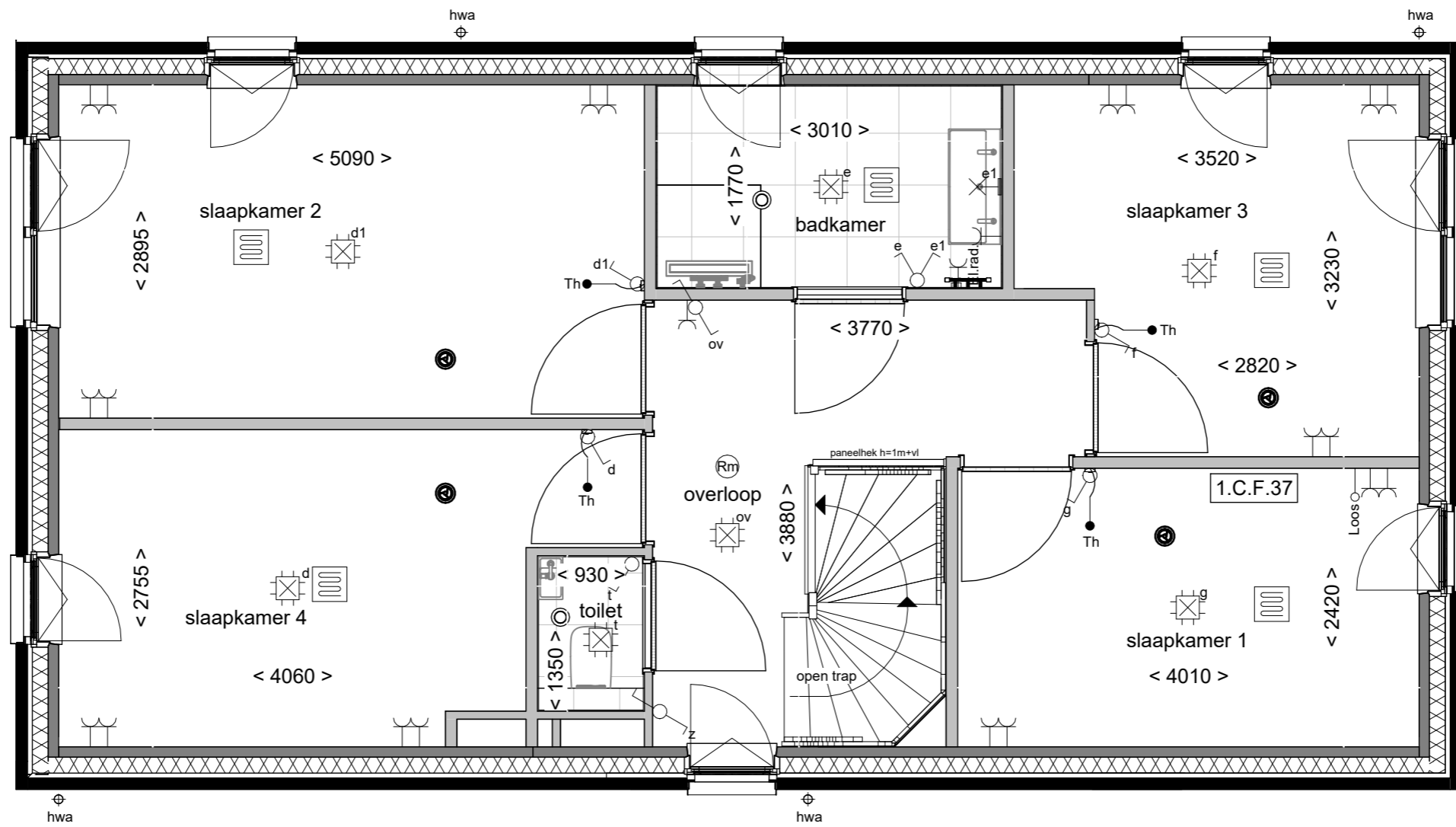

Indeling met 2  
slaapkamers voor

Tekening:

Woningtype: F60+

Bouwnummer: 8/9/14/15/18/19/20

Optienummer: 1.C.F.37

Bladformaat: A3

Schaal: 1:50

Datum: 21-04-2026



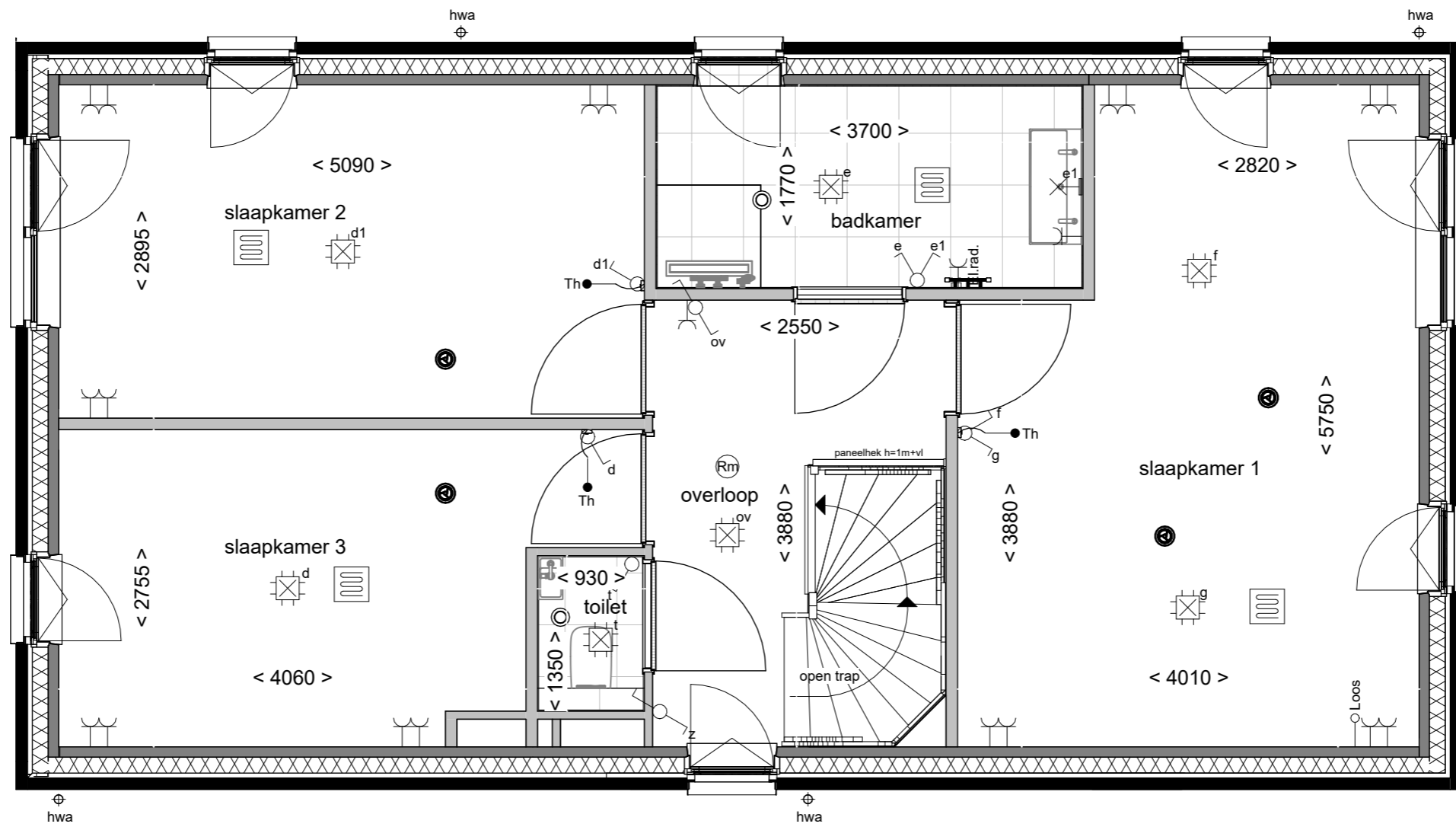

Tekening: Verlengen badkamer

Woningtype: F60+

Bouwnummer: 8/9/14/15/18/19/20

Optienummer: 1.C.F.45

Bladformaat: A3

Schaal: 1:50

Datum: 21-04-2026

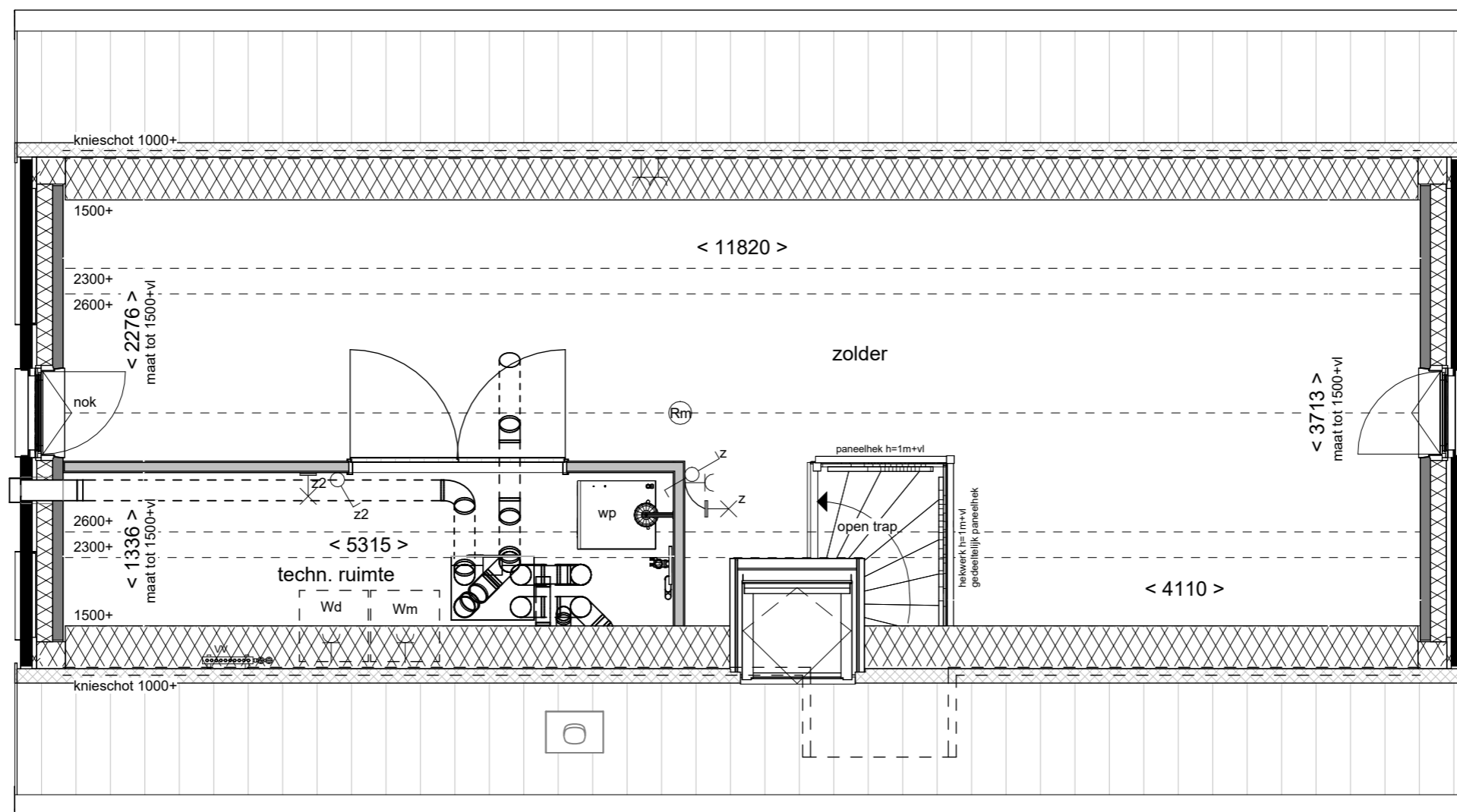

**Indeling met  
techniekkast**

Tekening: **Indeling met techniekkast**

---

Woningtype: **F60+**

---

Bouwnummer: **8/9/14/15/18/19/20**

---

Optienummer: **1.C.F.70**

---

Bladformaat: **A3**

---

Schaal: **1:50**

---

Datum: **21-04-2026**

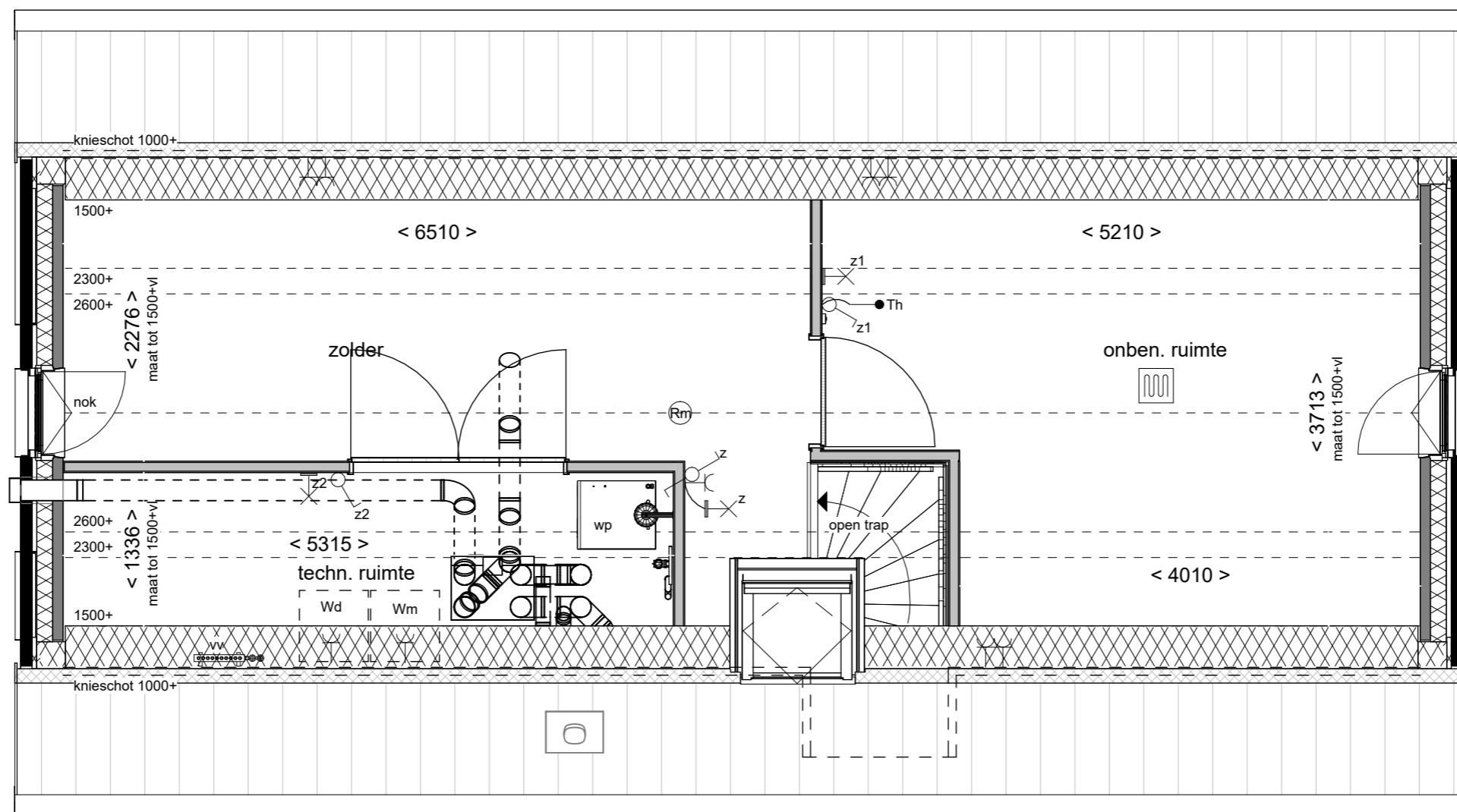

**Wonen aan  
de Gantel**

Indeling met één  
onbenoemde ruimte

Tekening:

Woningtype: F60+

Bouwnummer: 8/9/14/15/18/19/20

Optienummer: 1.C.F.72

Bladformaat: A3

Schaal: 1:50

Datum: 21-04-2026

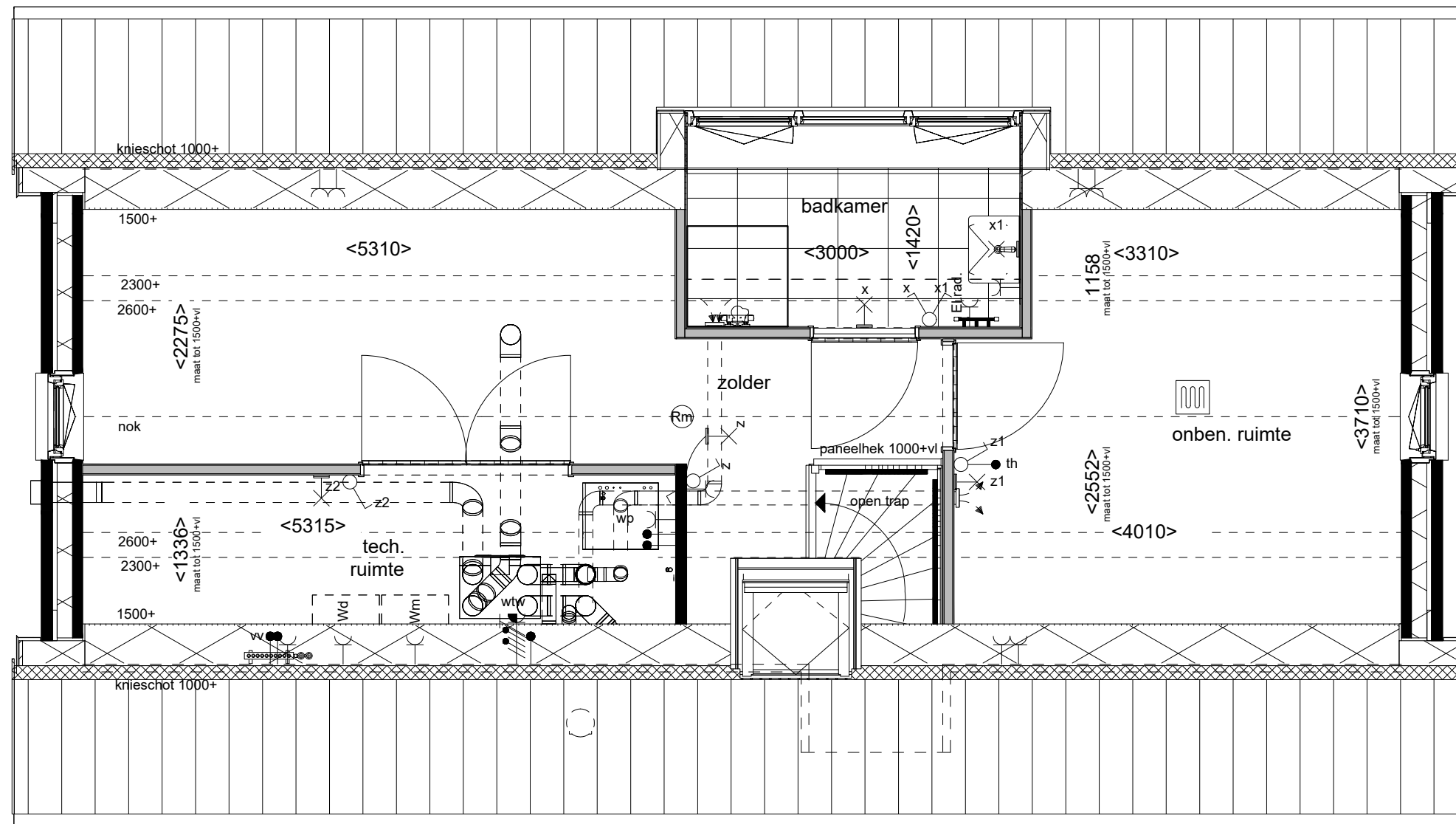

Indeling met 1 onb. ruimte + badkamer

Tekening:

Woningtype: F60+

Bouwnummer: 14, 15, 18, 19 en 20

Optienummer: 1.C.F.74A

Bladformaat: A3

Schaal: 1:50

Datum: 21-04-2026

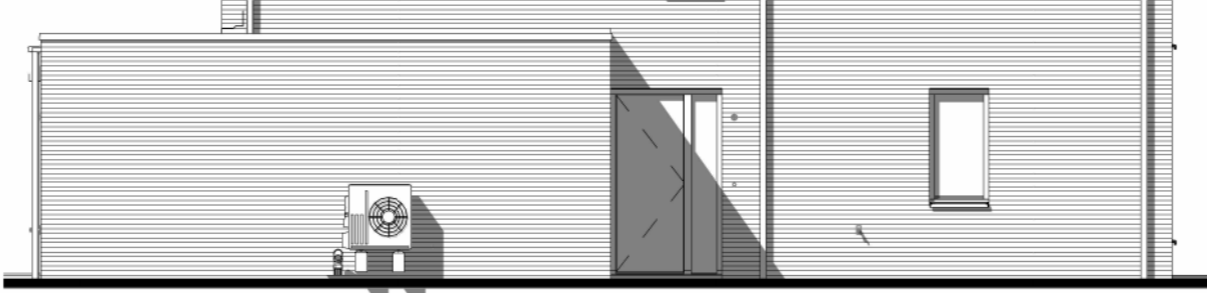
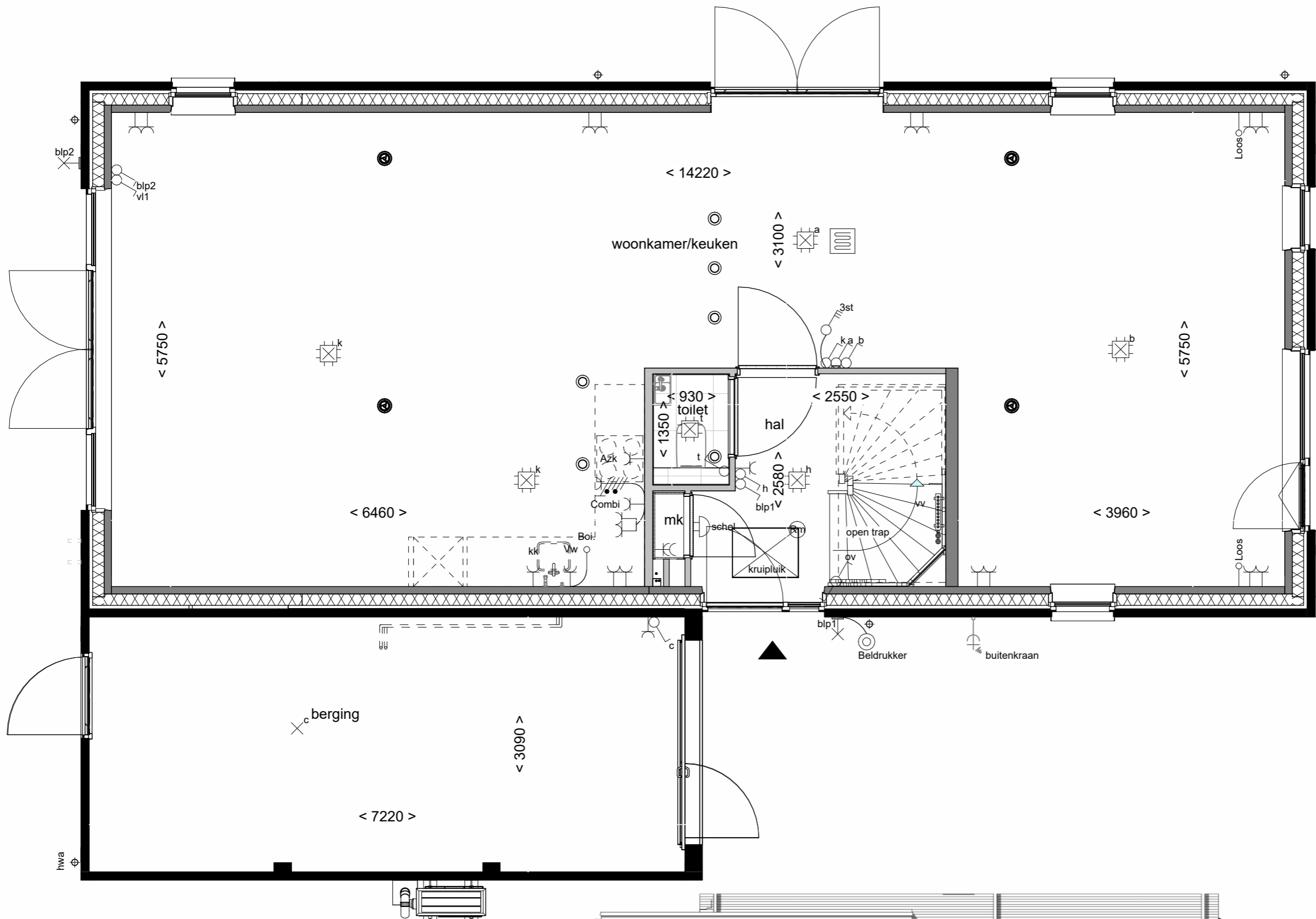

Linkerzijgevel schaal 1:100



vorstvrij buitenkraan  
naast voordeur

Tekening:	
Woningtype:	F60+
Bouwnummer:	8/9/14/15/18/19/20
Optienummer:	2.K.0.40
Bladformaat:	A3
Schaal:	1:50 / 1:100
Datum:	21-04-2026

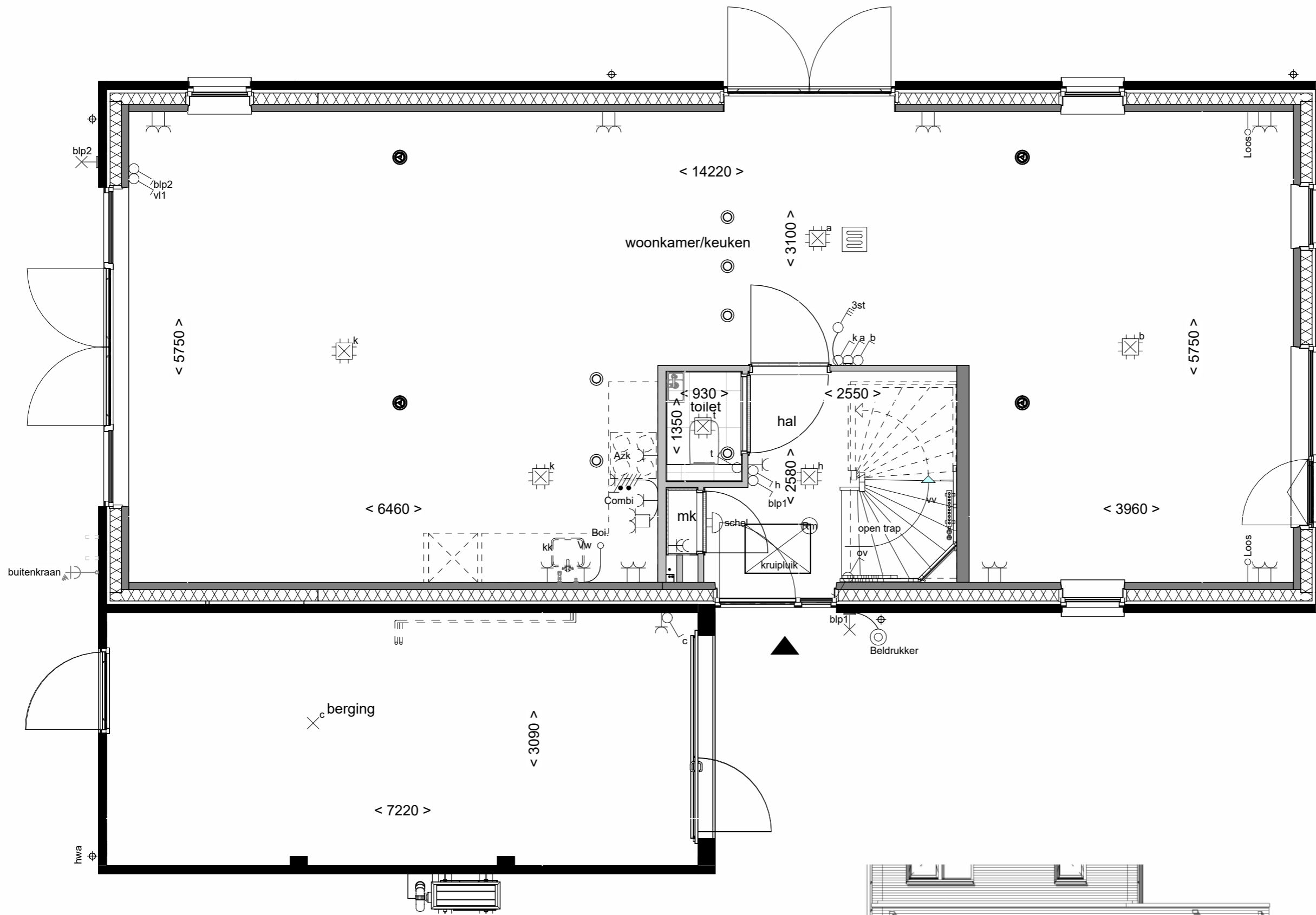

Achtergevel schaal 1:100



vorstvrij buitenkraan  
achter

Tekening:	
Woningtype:	F60+
Bouwnummer:	8/9/14/15/18/19
Optienummer:	2.K.0.44
Bladformaat:	A3
Schaal:	1:50 / 1:100
Datum:	21-04-2026

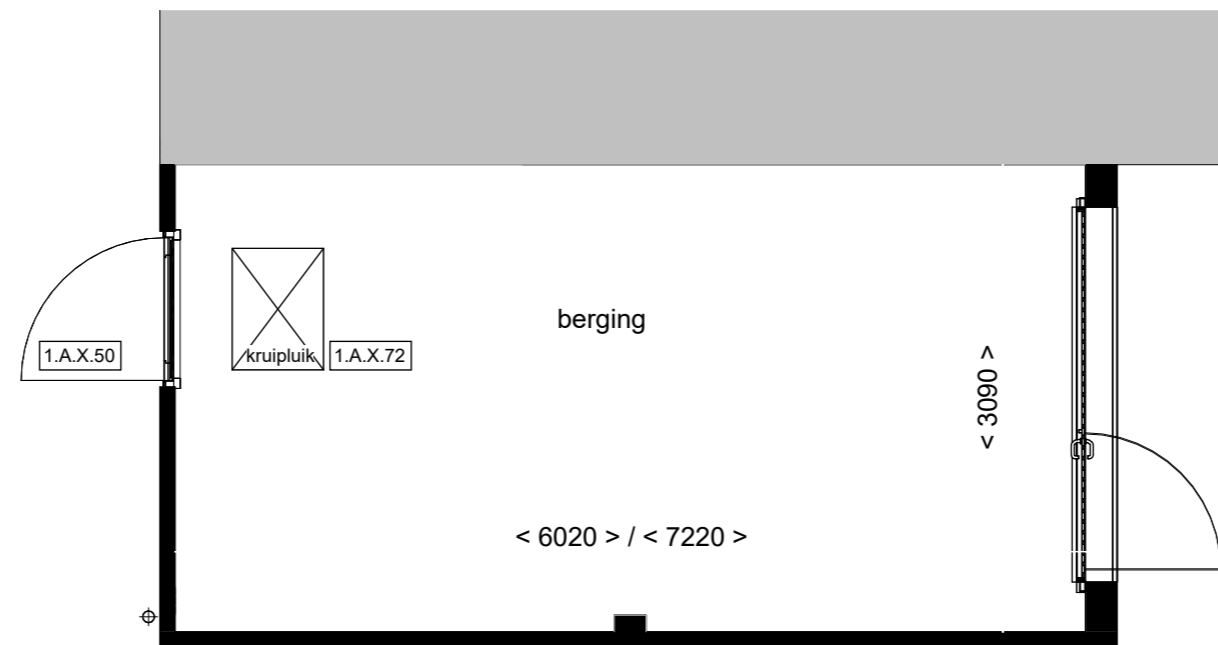

**Wonen aan  
de Gantel**

**Kruipluik in de  
berging**

Tekening:

Woningtype: E60/F60/F60+/F60D

Bouwnummer: 1 t/m 20

Optienummer: 1.A.X.50 / 1.A.X.72

Bladformaat: A3

Schaal: 1 : 50

Datum: 21-04-2026

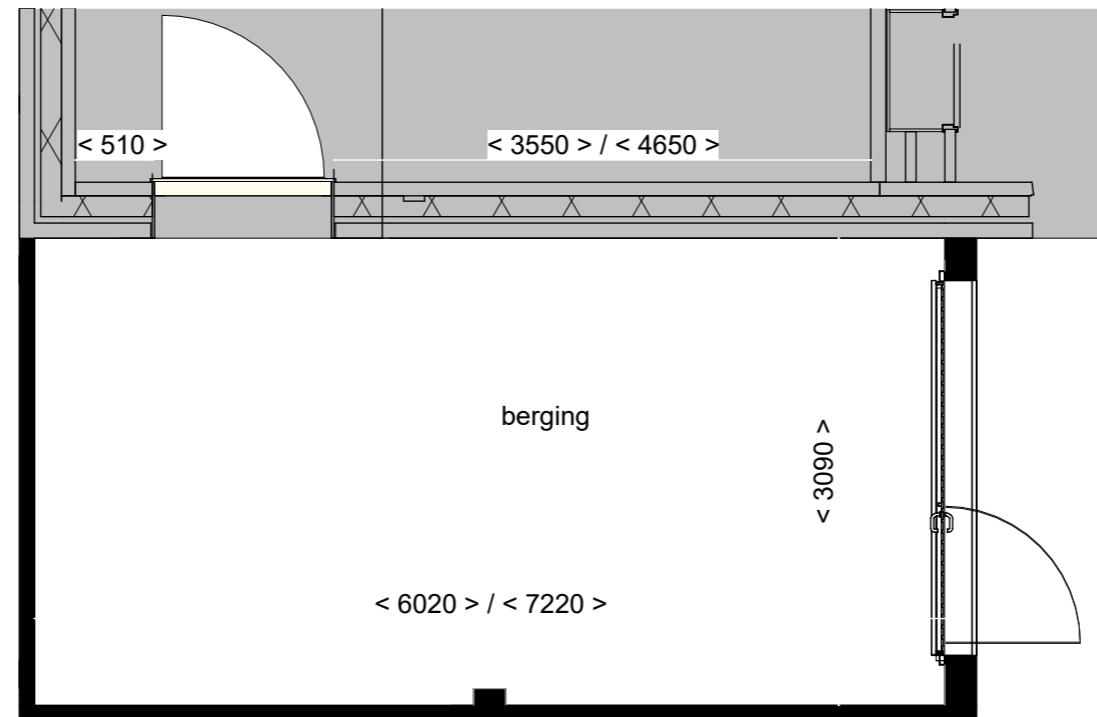

Tekening: Buitendeur tussen woning en berging

Woningtype: E60/F60/F60+

Bouwnummer: 1 t/m 19

Optienummer: 1.A.X.74 B

Bladformaat: A3

Schaal: 1 : 50

Datum: 21-04-2026

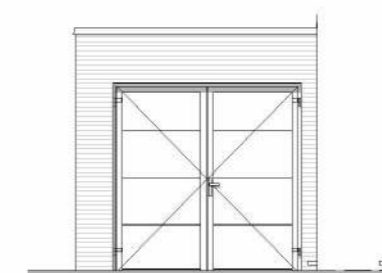
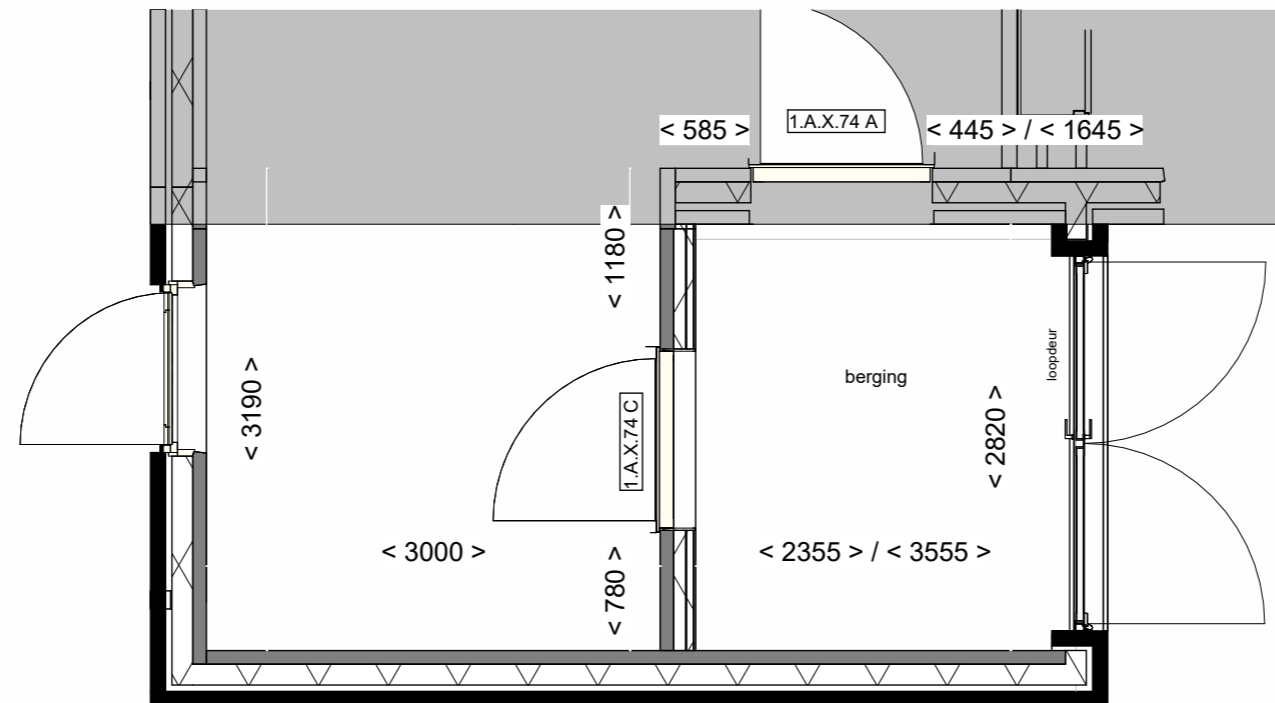

Voorgevel schaal 1:100



**Wonen aan  
de Gantel**

Tekening: Buitendeur tussen woning en berging

Woningtype: E60/F60/F60+

Bouwnummer: 1 t/m 19

Optienummer: 1.A.X.74 C

Bladformaat: A3

Schaal: 1:50

Datum: 21-04-2026

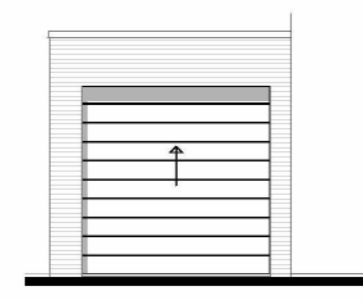
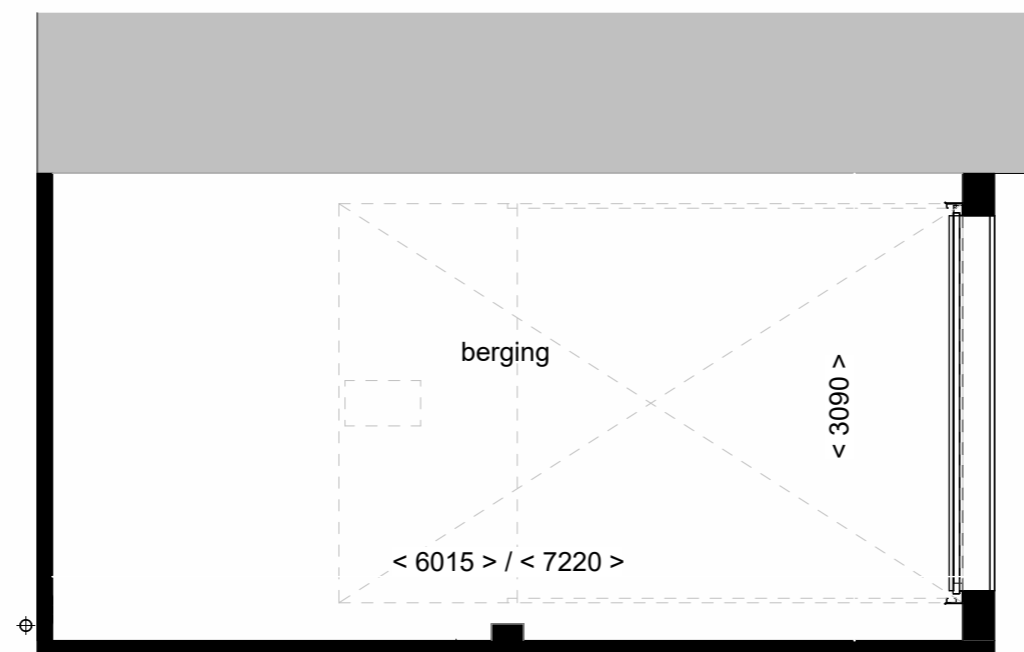

Voorgevel schaal 1:100



**Wonen aan  
de Gantel**

Sectionaaldeur ipv  
kanteldeur

Tekening:

Woningtype: E60/F60/F60+/F60D

Bouwnummer: 1 t/m 20

Optienummer: 1.A.X.80

Bladformaat: A3

Schaal: 1:50

Datum: 21-04-2026

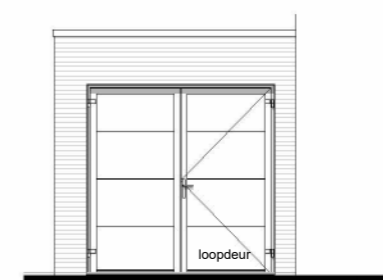
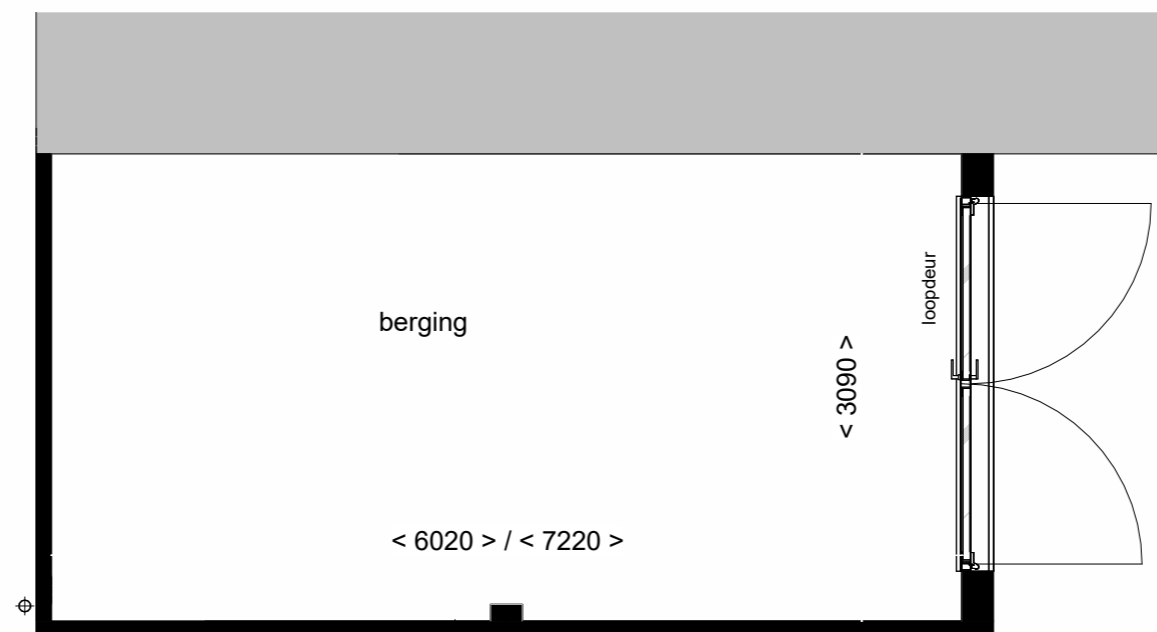

Voorgevel schaal 1:100



**Wonen aan  
de Gantel**

Dubbele

Tekening: openslaande deuren

Woningtype: E60/F60/F60+/F60D

Bouwnummer: 1 t/m 20

Optienummer: 1.A.X.84

Bladformaat: A3

Schaal: 1:50

Datum: 21-04-2026

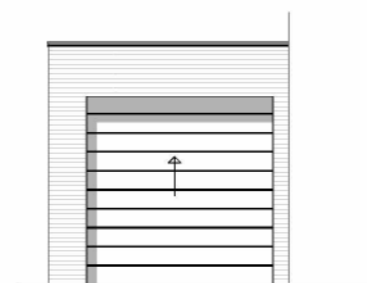
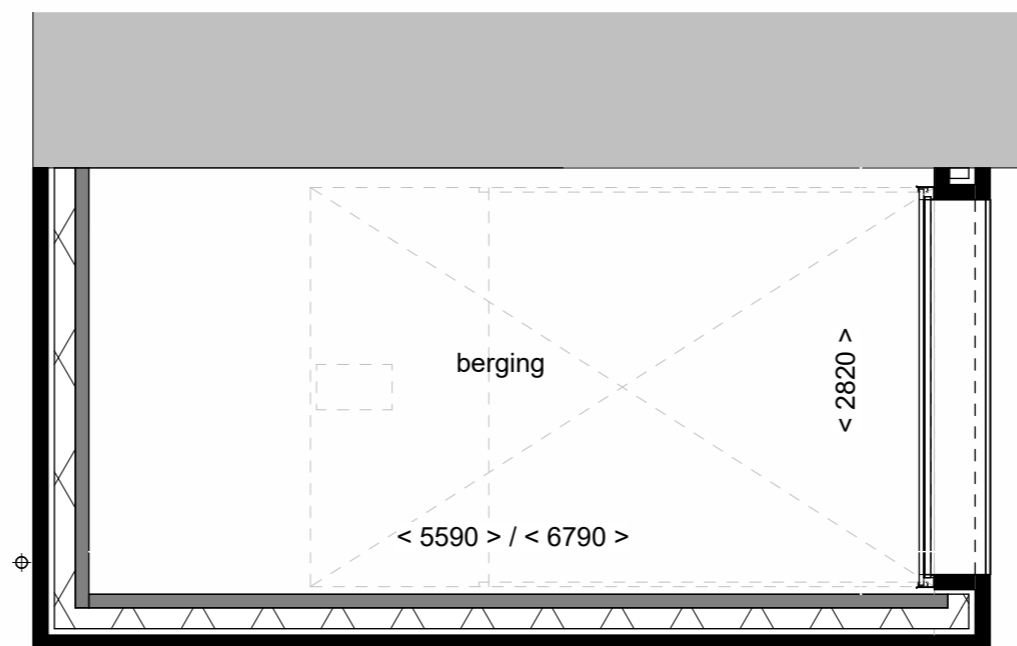

Voorgevel schaal 1:100



Achtergevel schaal 1:100



Tekening: Isoleren berging

Woningtype: E60/F60/F60+/F60D

Bouwnummer: 01 t/m 20

Optienummer: 1.A.X.86

Bladformaat: A3

Schaal: 1:50

Datum: 21-04-2026

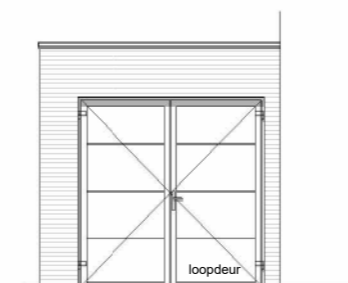
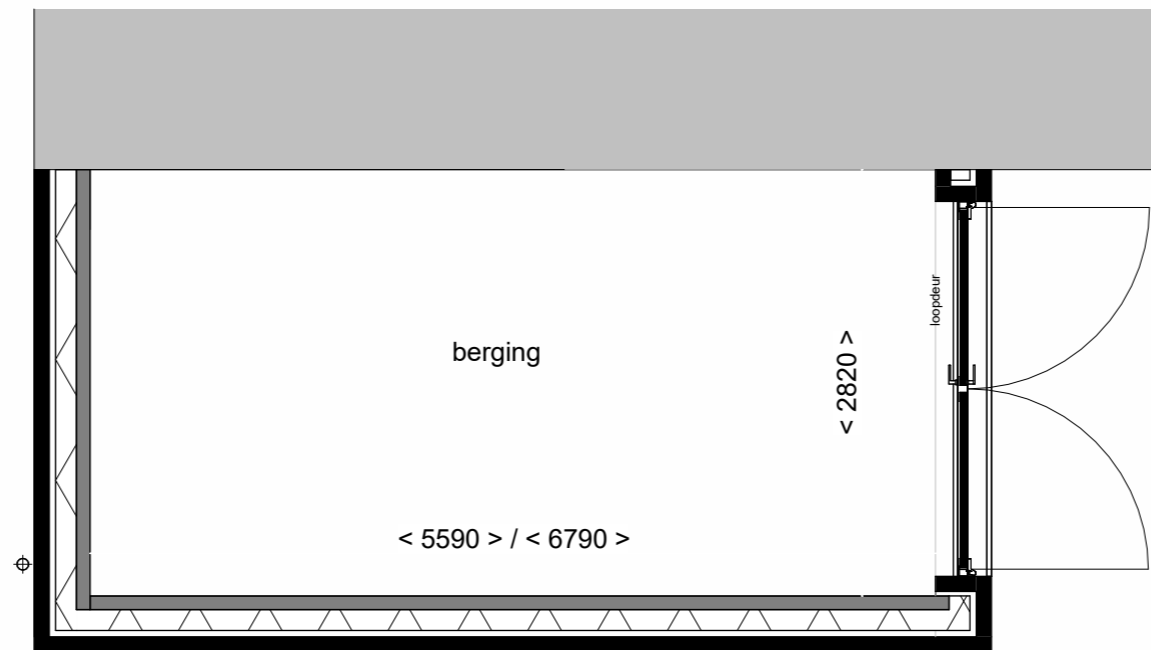

Voorgevel schaal 1:100



Achtergevel schaal 1:100



**Wonen aan  
de Gantel**

Dubbele deuren,  
isoleren

Tekening:

Woningtype: E60/F60/F60+/F60D

Bouwnummer: 1 t/m 20

Optienummer: 1.A.X.94

Bladformaat: A3

Schaal: 1:50

Datum: 21-04-2026