

Renvooi

-  - entree woongebouw
-  - erfgrans
-  - parkeervak eigen terrein
-  - parkeervak openbaar
-  - houten vlonder
-  - pergola
-  - haag laag
-  - haag hoog
-  - water
-  - openbaar groen
-  - wandelpad houtsnippers
-  - voetpad
-  - inrit
-  - straat
-  - talud
-  - boom, positie in overleg met koper
-  - indicatie positie riolering
-  - zone erfdienstbaarheid
-  - klinkerbestrating

parkeerplekken en posities bomen indicatief

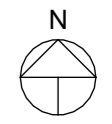

Tekening: **Situatie totaal**

Woningtype: **E60,E60D,F60,F60+**

Bouwnummer: **1 t/m 31**

Bladnummer: **VT-S-00**

Bladformaat: **A3**

Schaal: **1:750**

Datum: **21-04-2026**

Grote Gantel

Renvooi

-  - entree woongebouw
-  - erfgrans
-  - parkeervak eigen terrein
-  - parkeervak openbaar
-  - houten vlonder
-  - pergola
-  - haag laag
-  - haag hoog
-  - water
-  - openbaar groen
-  - wandelpad houtsnippers
-  - voetpad
-  - inrit
-  - straat
-  - talud
-  - boom, positie in overleg met koper
-  - indicatie positie riolering
-  - zone erfdienstbaarheid
-  - klinkerbestrating

parkeerplekken en posities bomen indicatief



Tekening: Situatie bnr. 12-15

Woningtype: E60, E60D, F60+

Bouwnummer: 12, 13, 14, 15

Bladnummer: VT-S-04

Bladformaat: A3

Schaal: 1:200

Datum: 21-04-2026

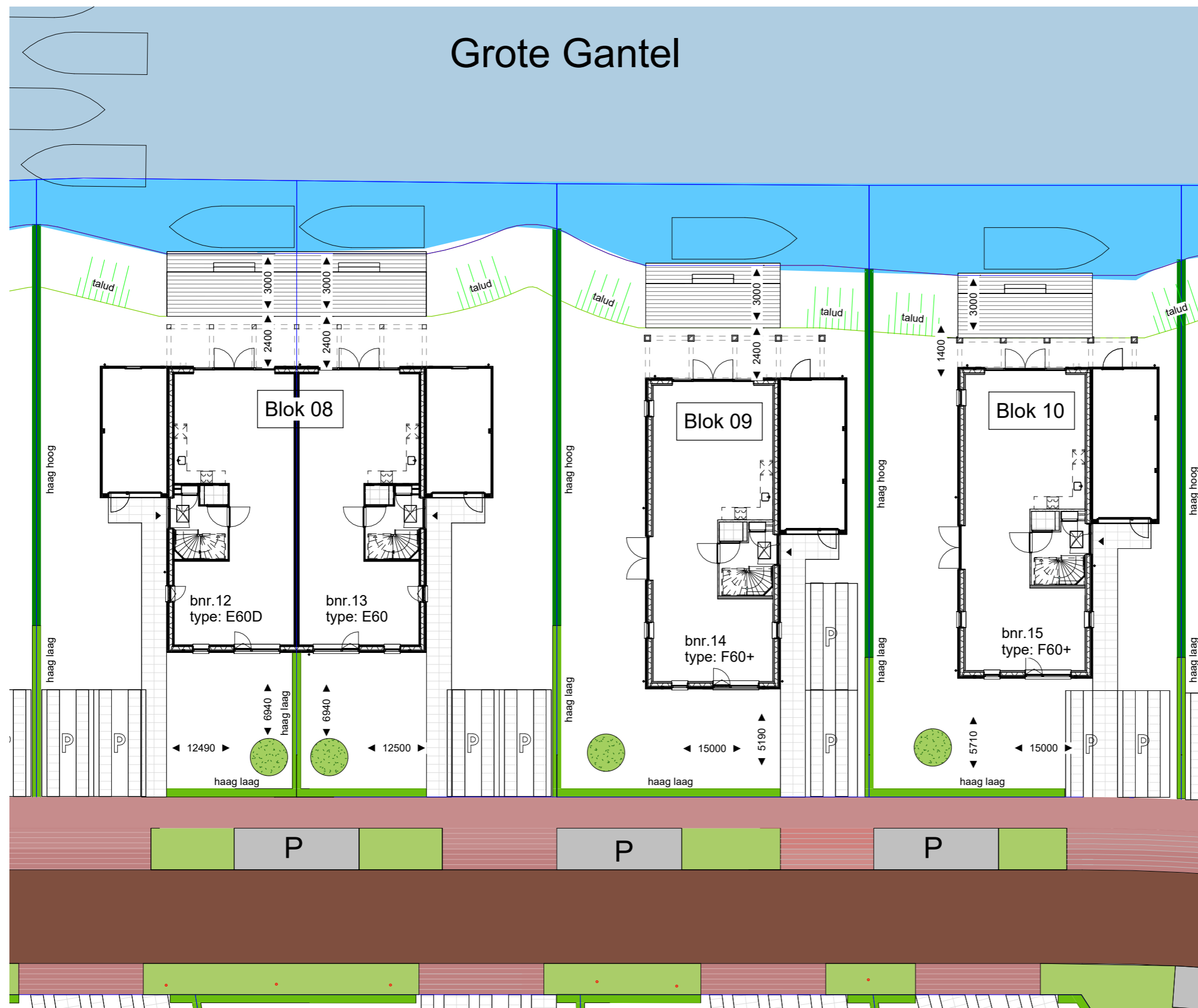

Renvooi materialen



dakpan antracietgrijs



metselwerk kleur grijswit gesinterd
code A: EN1166 WF WS



metselwerk kleur bruin nuance
code B: HM1106 WF WS



metselwerk kleur bruin caramel
code C: EN1165 WF WS



gevelbetimmering vuren vergrijsd

Renvooi bouwkundig



entree woning



metselwerk



isolatie



dragende wand



niet dragende binnenwand

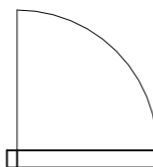

buitendeur

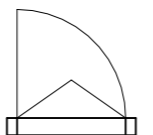

draairaam

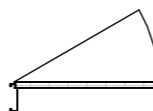

binnendeurkozijn (met bovenlicht)

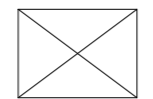

kruipluik

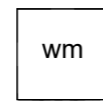

wm opstelplaats wasmachine

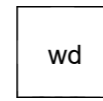

wd opstelplaats wasdroger



kk opstelplaats koelkast

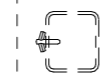

principe opstelling keukenblok

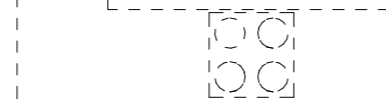

onbenoemde ruimte volgens krijtstreepmethode

Renvooi installaties



aansluitpunt licht, wand



centraaldoos met lichtpunt



armatuur aan de wand



rookmelder



aansluitpunt niet bedraad / loos



aansluitpunt bedraad data, niet afgemonteerd



beldrukker



schel



schakelaar, 1-polig



werkschakelaar tbv PV-panelen



driestandenschakelaar tbv wtw



schakelaar, wissel



schakelaar, serie



pulsschakelaar tbv warmteterugwinunit



wandcontactdoos 1-voudig met beschermingscontact



wandcontactdoos 2-voudig met beschermingscontact



thermostaatleiding, bedraad



wandcontactdoos tbv warmteterugwinunit



wtw mechanische ventilatie-unit incl. warmteterugwinunit



wp warmtepomp



inblaasventiel mechanische ventilatie



afzuigventiel mechanische ventilatie



verdelersysteem vloerverwarming



ruimte vzw vloerverwarming



elektrische radiator



kanalen in het zicht



doucheput



lijngoot douche



buitenkraan



Disclaimer

De op deze tekeningen aangegeven maten zijn circa maten in millimeters en tussen de wanden / vloeren gemeten, waarbij geen rekening is gehouden met enige wandafwerking, plinten, aftimmering, etc. In verband met de nauwkeurige uitwerking van details, constructie, maatvoering, materialen e.d. kunnen er kleine afwijkingen ontstaan ten opzichte van de nu vermelde gegevens. Deze geringe afwijkingen geven geen aanleiding tot verrekening. Aan de op deze tekening aangegeven maten kunnen derhalve geen rechten worden ontleend. De op deze tekeningen aangegeven maatvoering is niet geschikt voor opdrachten aan derden door koper(s). De posities van aansluitingen en installatie onderdelen zijn indicatief op tekening aangegeven. De exacte aantallen en posities zullen na berekening in het werk door de installateurs worden bepaald en kunnen afwijken van deze tekening.



**Wonen aan
de Gantel**

Tekening: **Renvooi**

Woningtype: **E60 / F60 / F60+**

Bouwnummer: **1 t/m 31**

Bladnummer: **VT-0-00c**

Bladformaat: **A3**

Schaal: **1 : 50**

Datum: **21-04-2026**



Vorgevel

Type: E60D
bnr: 12

Type: E60
bnr: 13

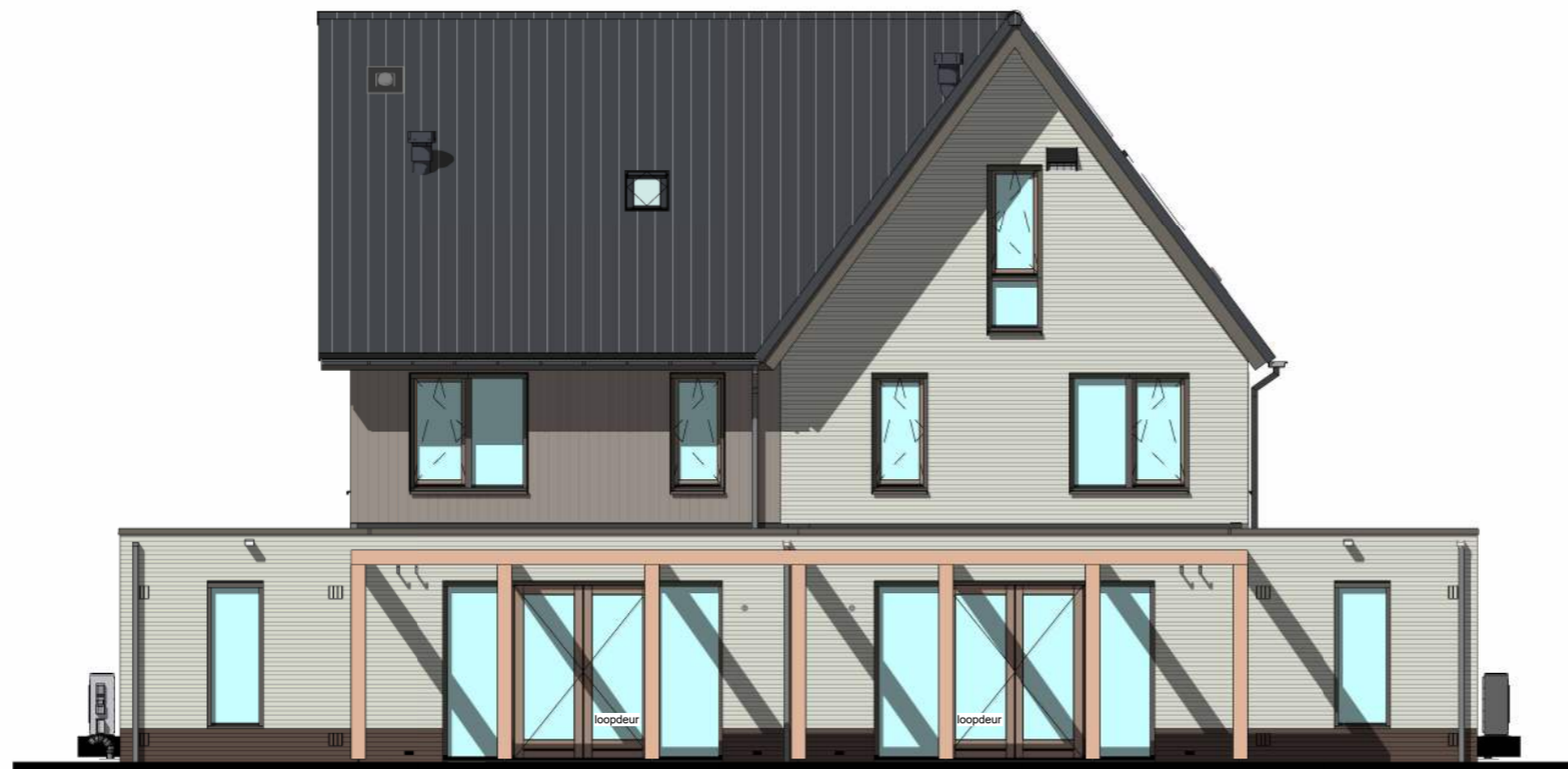

Achtergevel

Type: E60
bnr: 13

Type: E60D
bnr: 12



Tekening: Gevels blok 8

Woningtype: E60D / E60

Bouwnummer: 12 / 13

Bladnummer: VT-08-00a

Bladformaat: A3

Schaal: 1 : 100

Datum: 21-04-2026

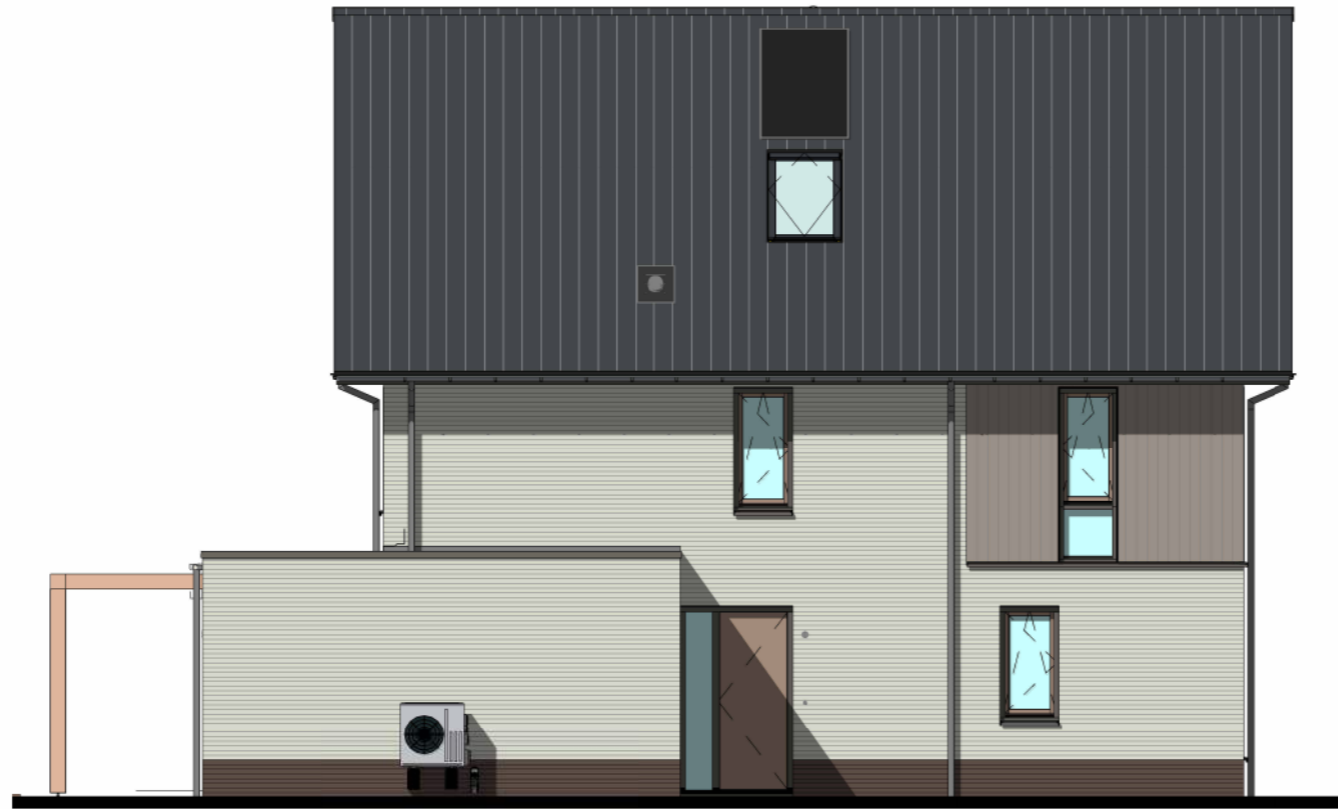

Linker zijgevel

Type: E60D
bnr: 12



Rechter zijgevel

Type: E60
bnr: 13



Tekening: Zijgevels blok 8

Woningtype: E60D / E60

Bouwnummer: 12 / 13

Bladnummer: VT-08-00b

Bladformaat: A3

Schaal: 1 : 100

Datum: 21-04-2026

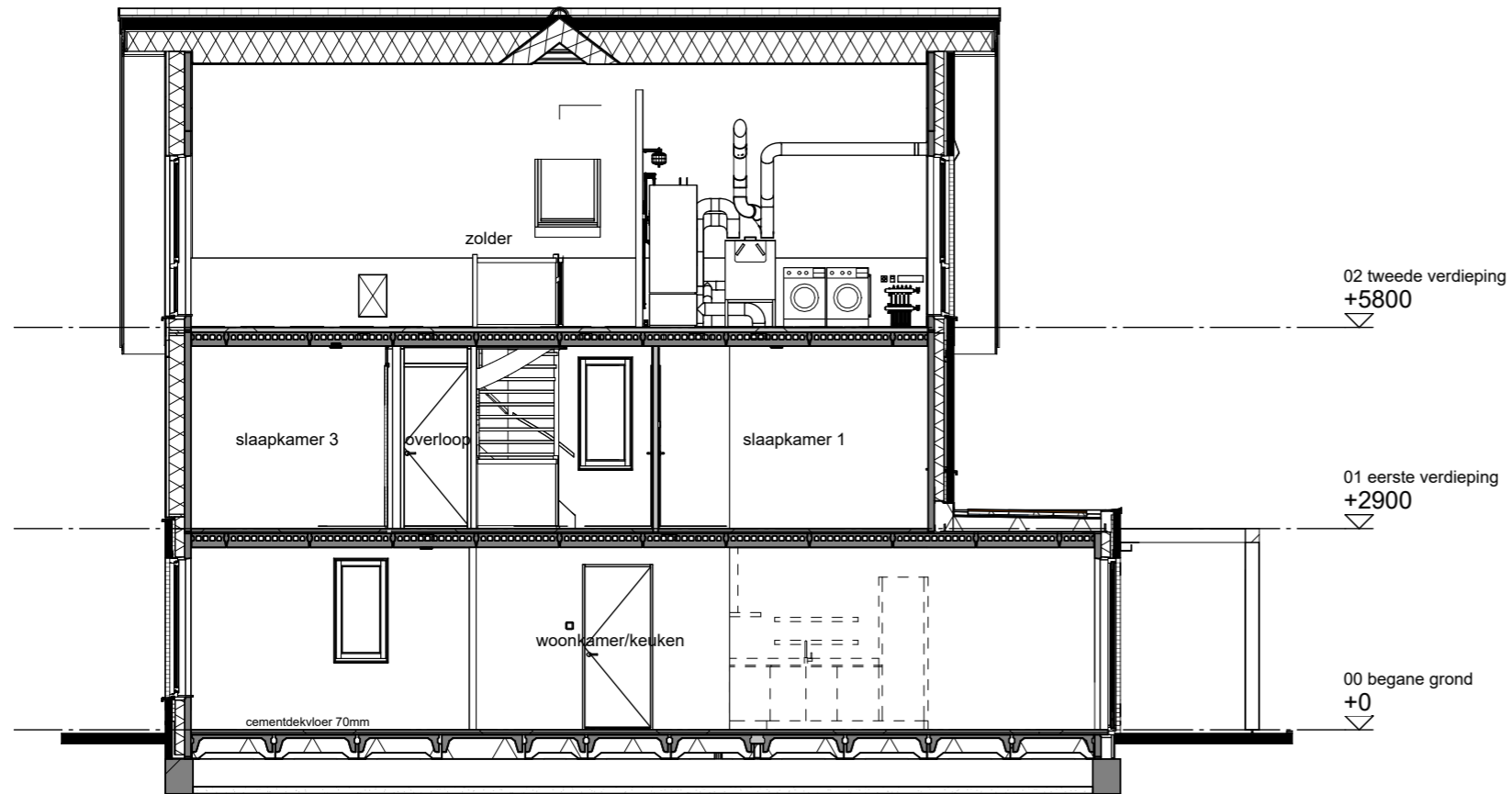

Doorsnede A-A

Type: E60D
bnr: 12

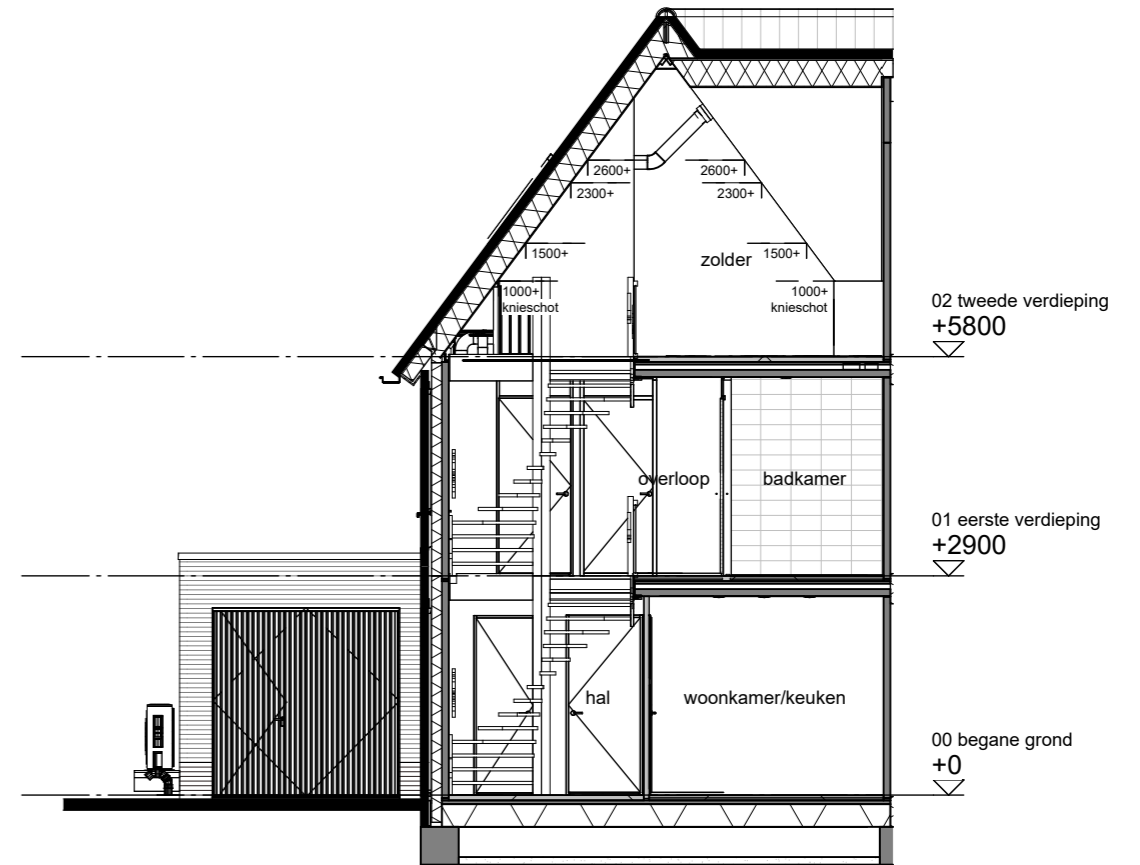

Doorsnede C-C

Type: E60D
bnr: 12

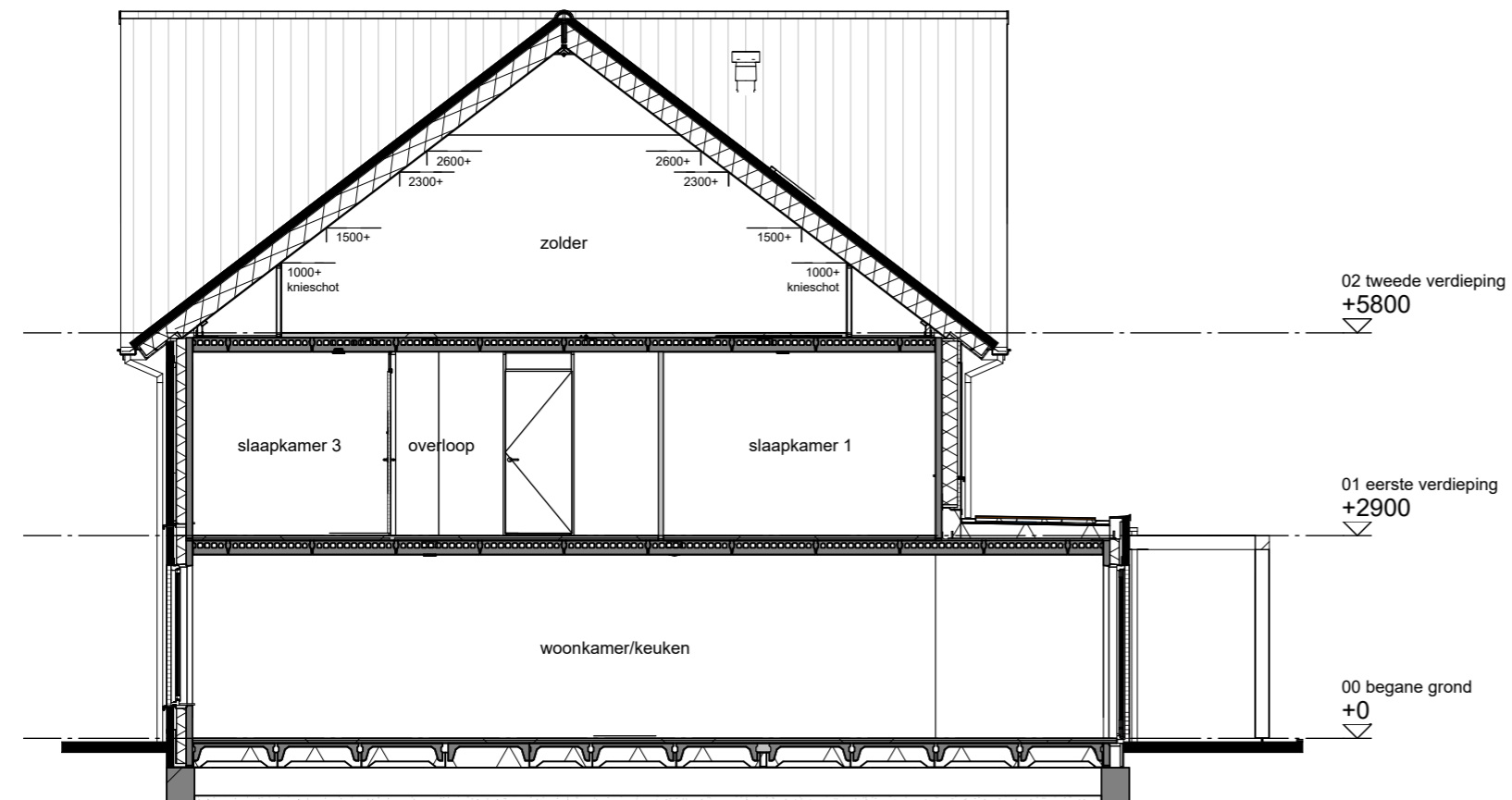

Doorsnede B-B

Type: E60
bnr: 13



Tekening: Doorsn. blok 8

Woningtype: E60D / E60

Bouwnummer: 12 / 13

Bladnummer: VT-08-00c

Bladformaat: A3

Schaal: 1 : 100

Datum: 21-04-2026

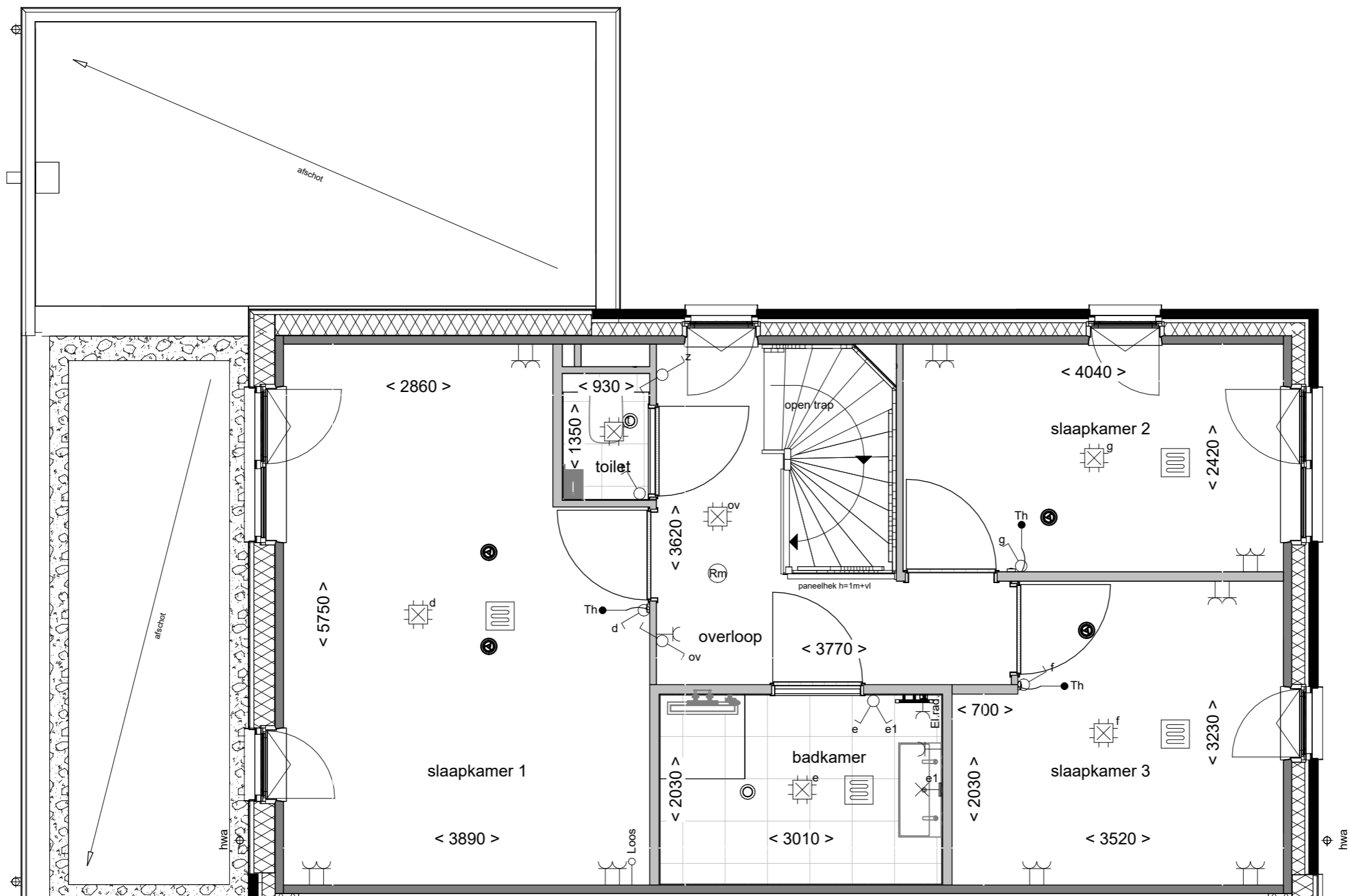

Tekening: **Eerste verdieping**

Woningtype: **E60**

Bouwnummer: **13**

Bladnummer: **VT-08-13b**

Bladformaat: **A3**

Schaal: **1 : 50**

Datum: **21-04-2026**

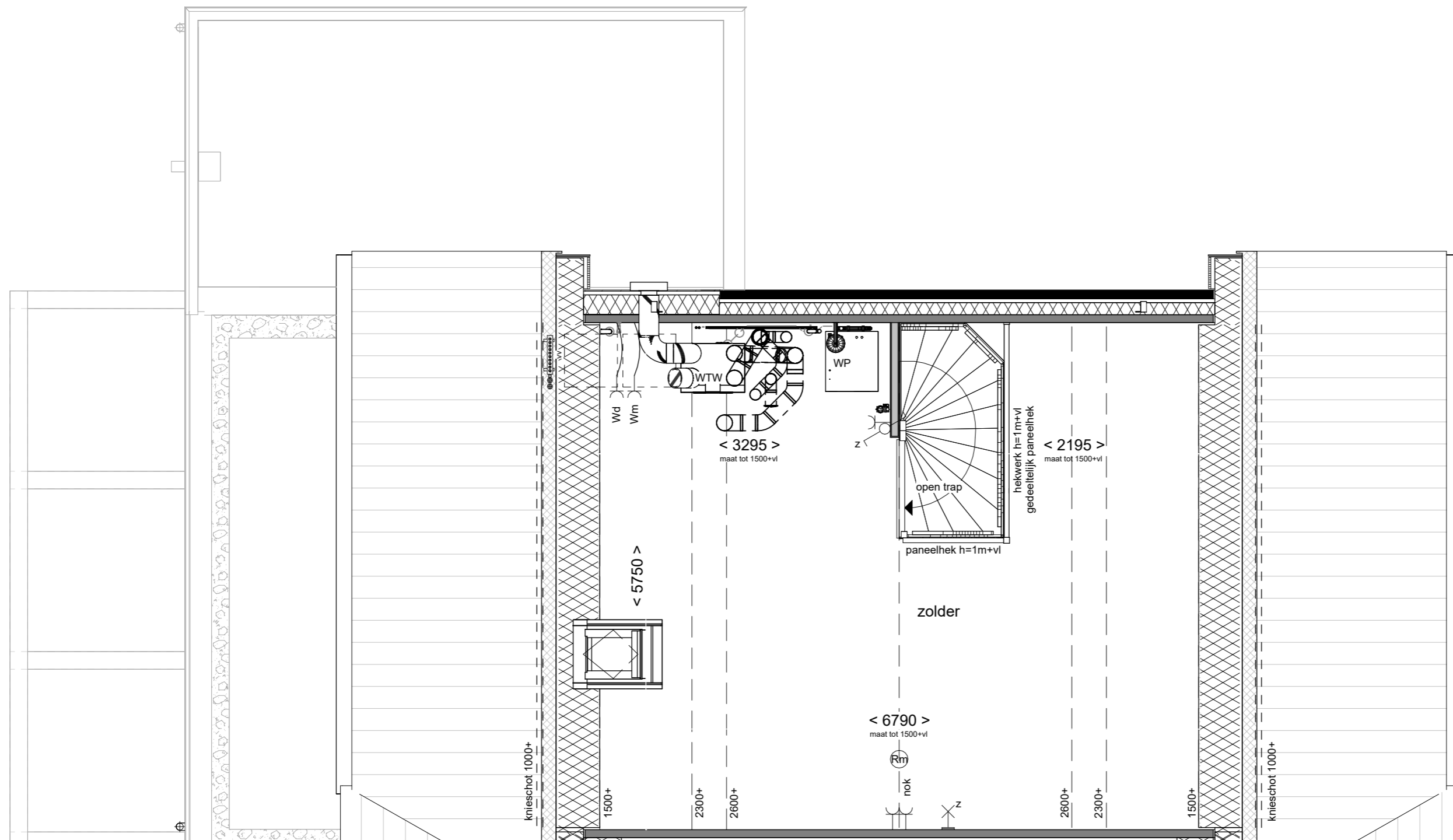

Tekening: Tweede verdieping

Woningtype: E60

Bouwnummer: 13

Bladnummer: VT-08-13c

Bladformaat: A3

Schaal: 1 : 50

Datum: 21-04-2026

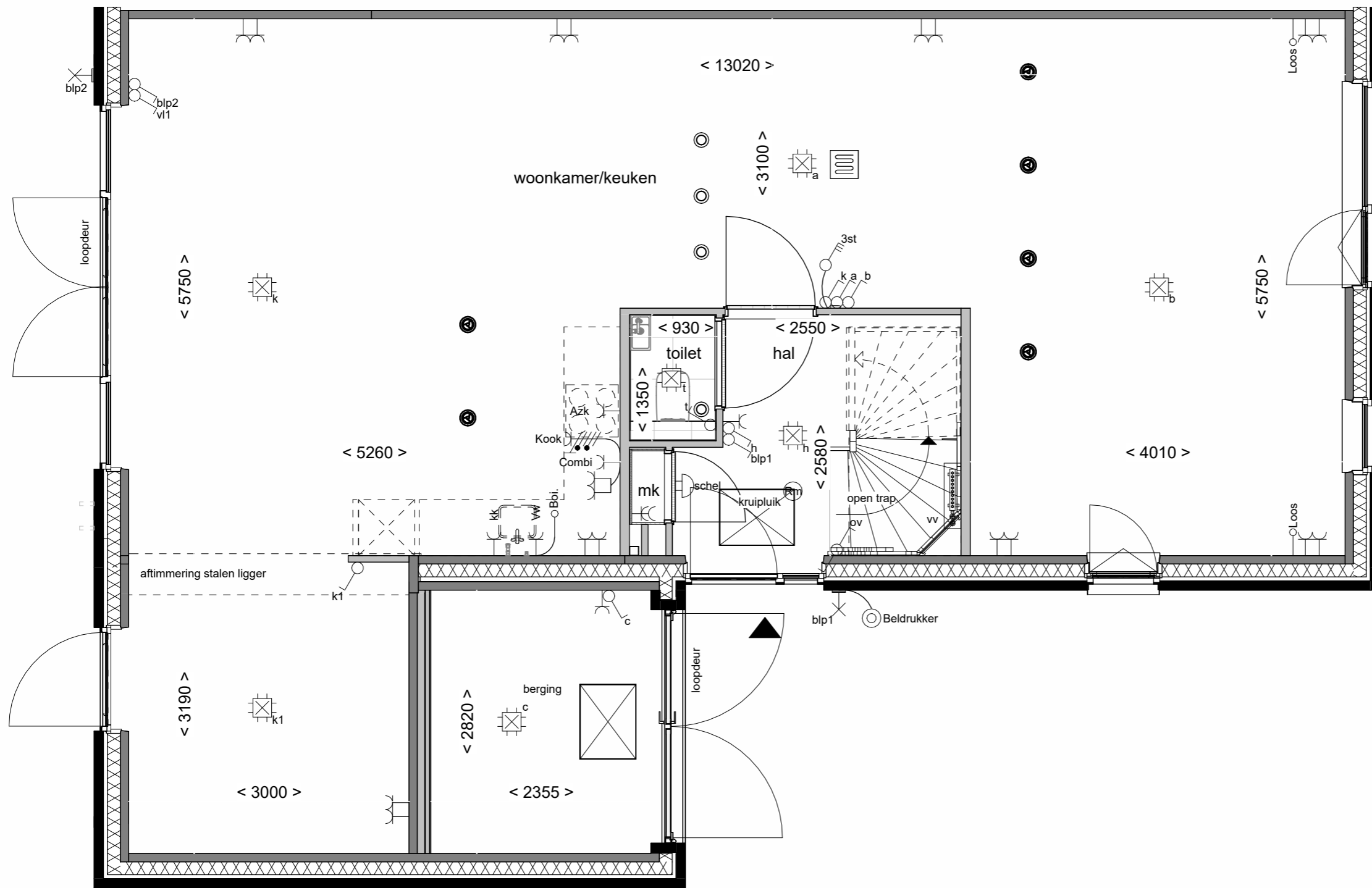

Begane grond

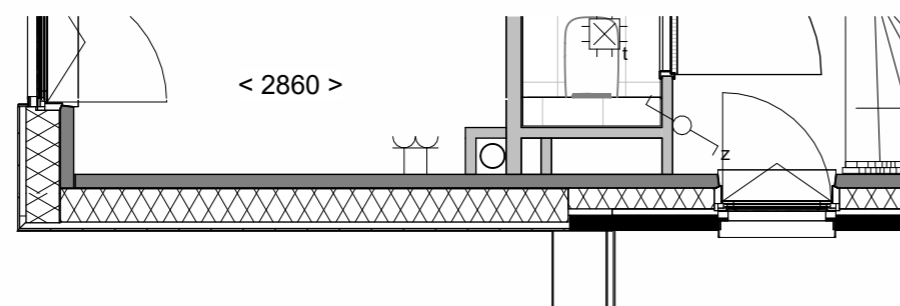

Eerste verdieping (extra schacht)



Achtergevel schaal 1:100



**Samenvoegen
berging bij wnk**

Tekening:	Samenvoegen berging bij wnk
Woningtype:	E60
Bouwnummer:	-
Optienummer:	1.A.E.14
Bladformaat:	A3
Schaal:	1:50 / 1:100
Datum:	21-04-2026

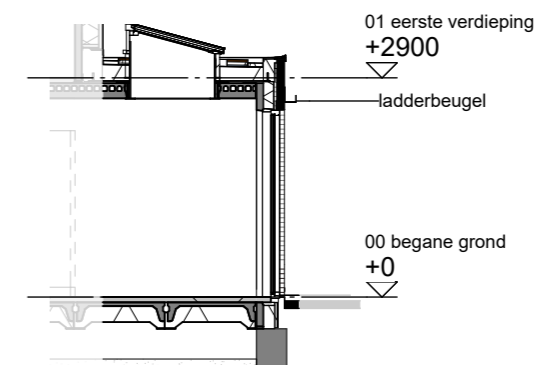
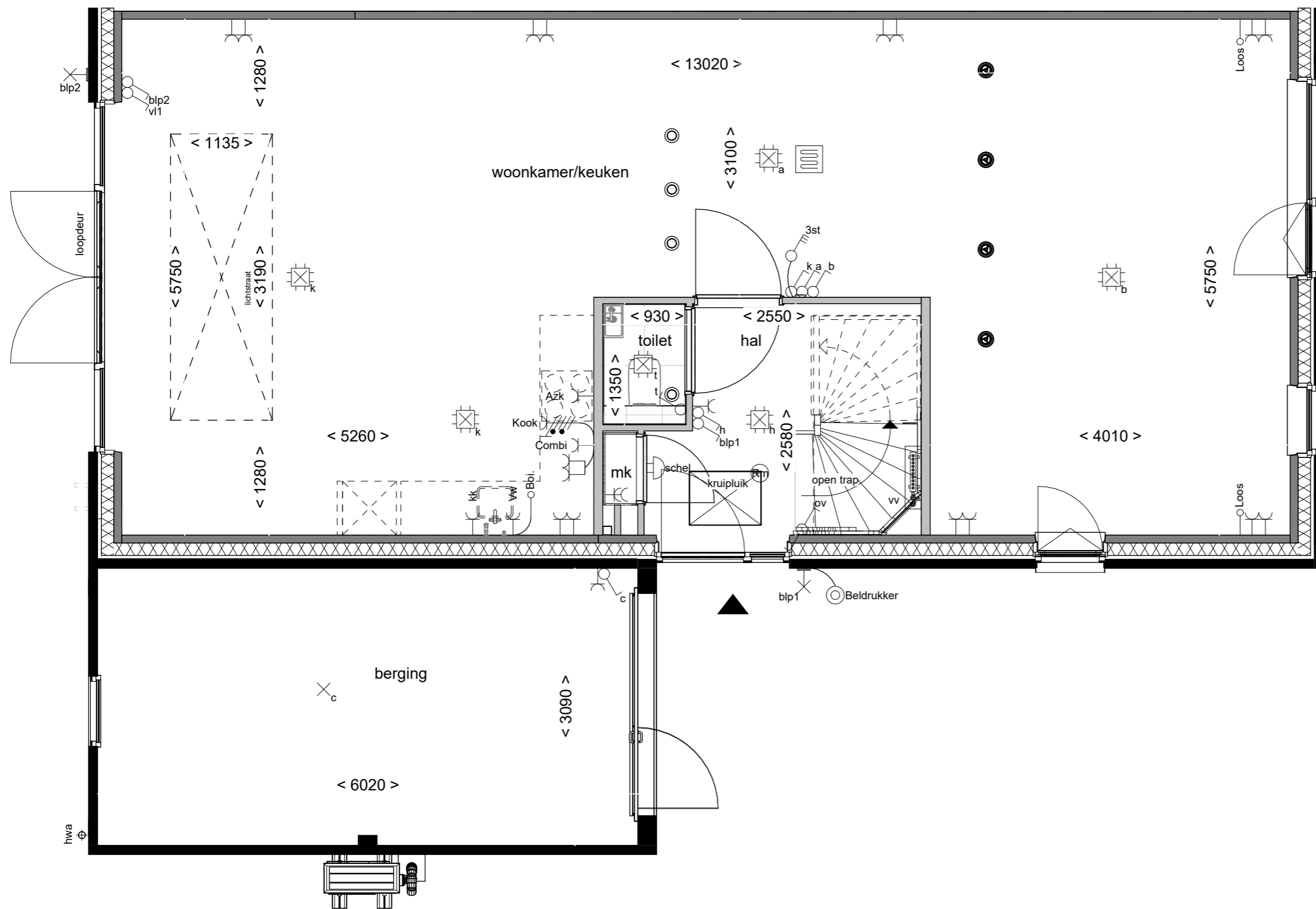

Doorsnede schaal 1:100



Lichtstraat in uitbouw
240cm

Tekening:	Lichtstraat in uitbouw 240cm
Woningtype:	E60
Bouwnummer:	-
Optienummer:	1.B.X.14
Bladformaat:	A3
Schaal:	1:50 / 1:100
Datum:	21-04-2026

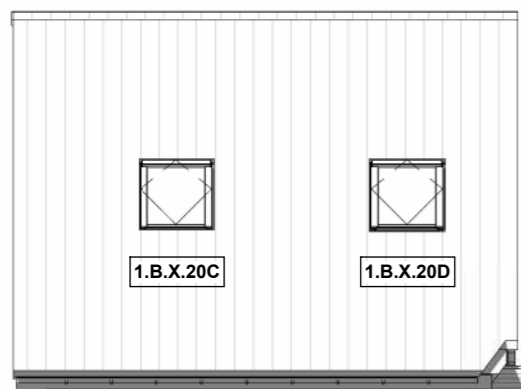
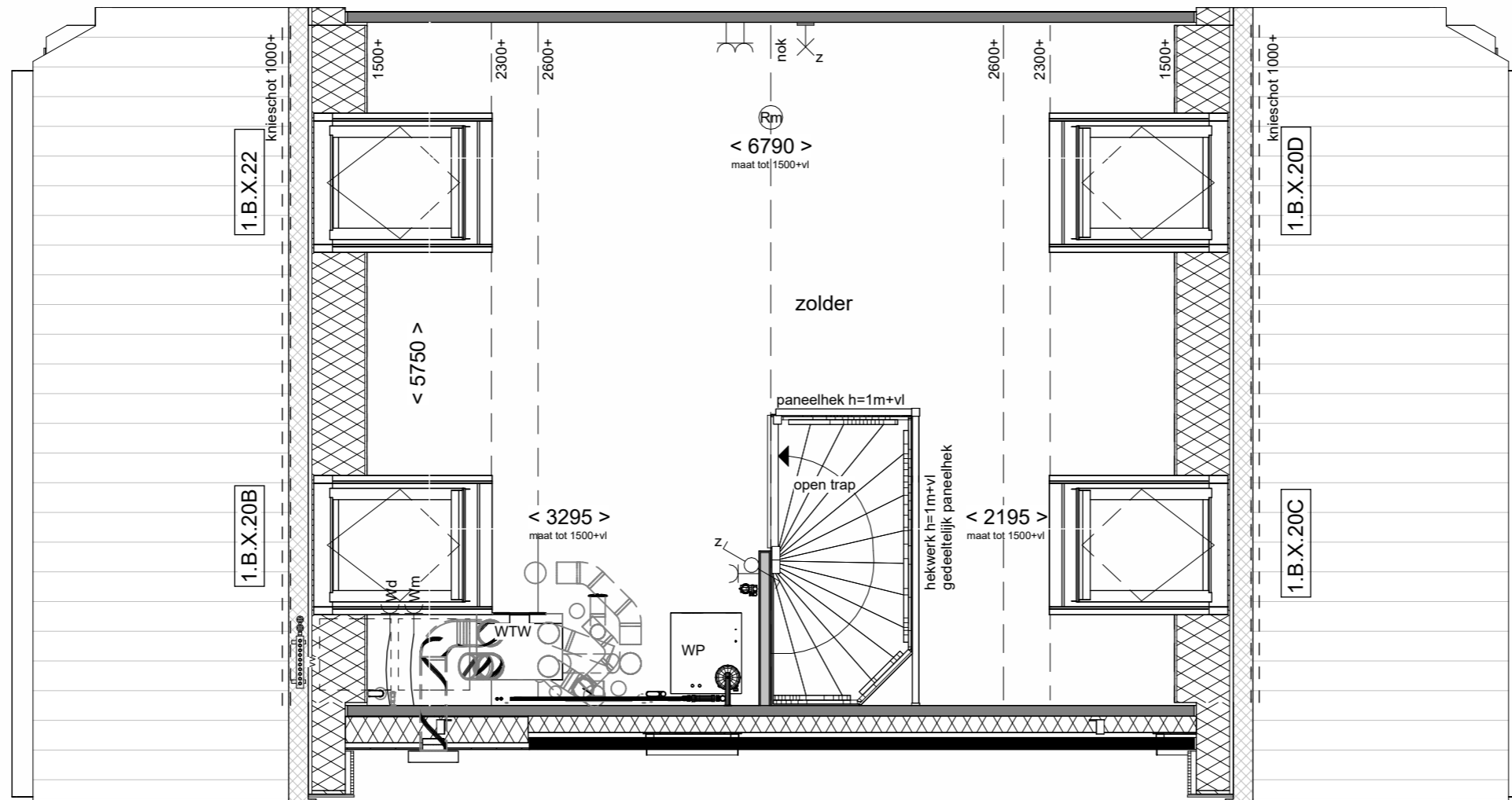

Voorgevel schaal 1:100

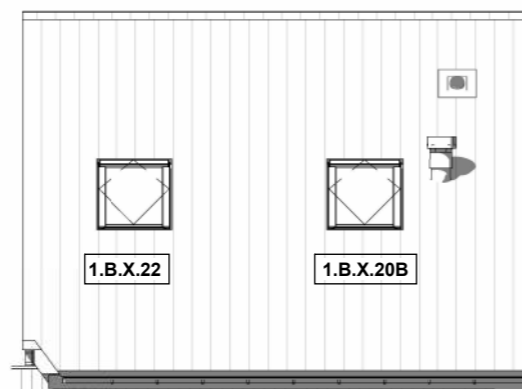

Achtergevel schaal 1:100

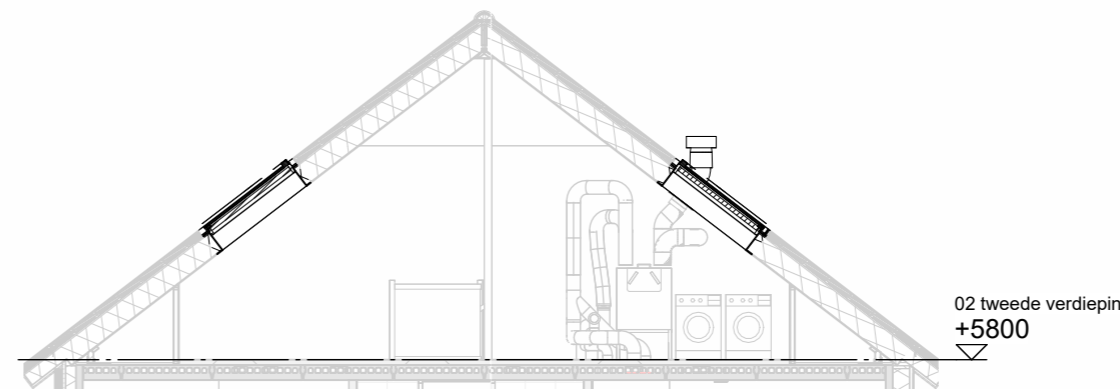

Doorsnede schaal 1:100



Dakramen voor- en achtergevel

Tekening:

Woningtype: E60

Bouwnummer: -

Optienummer: 1.B.X.20 / 1.B.X.22

Bladformaat: A3

Schaal: 1:50 / 1:100

Datum: 21-04-2026

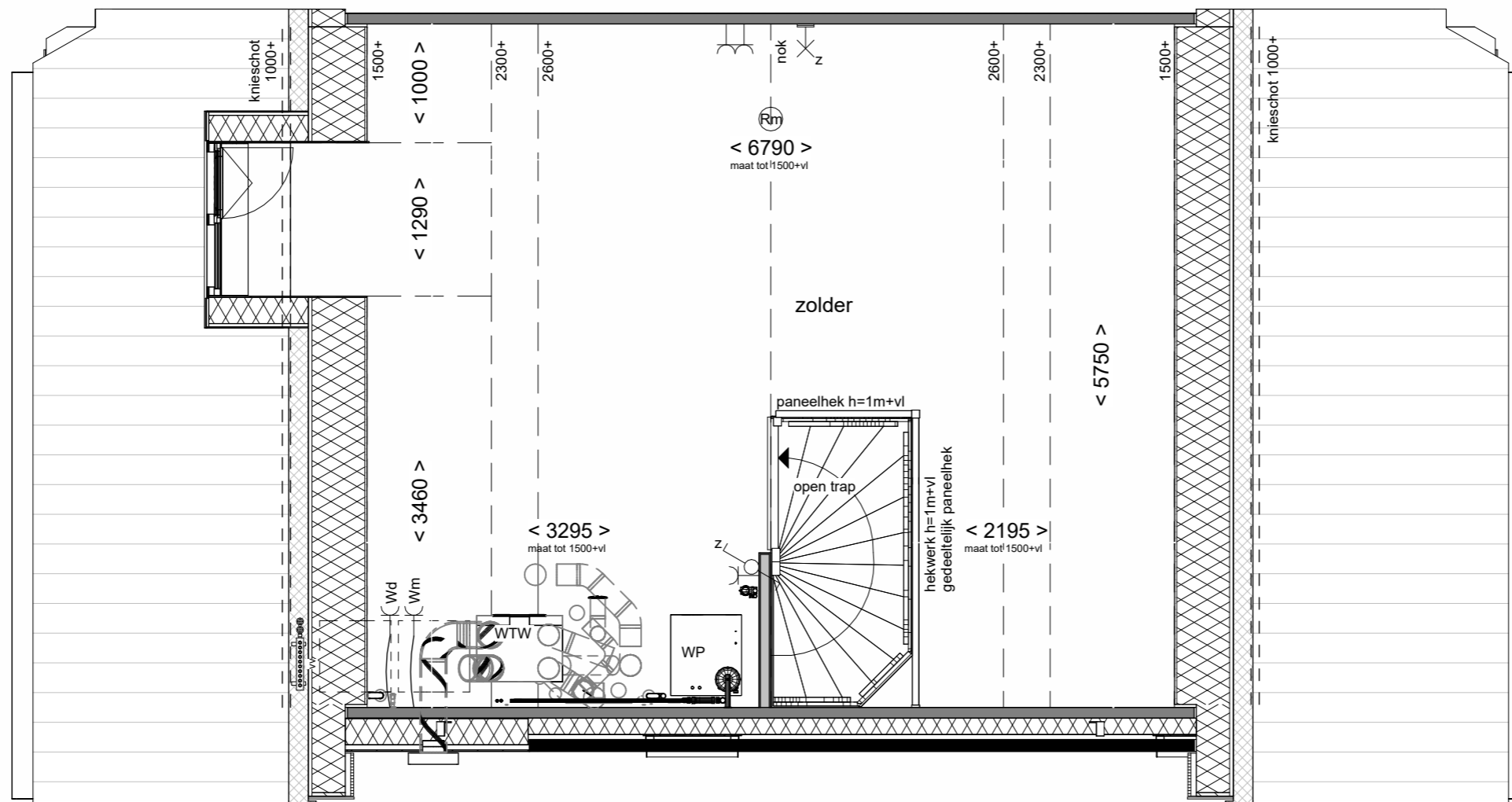

Achtergevel schaal 1:100

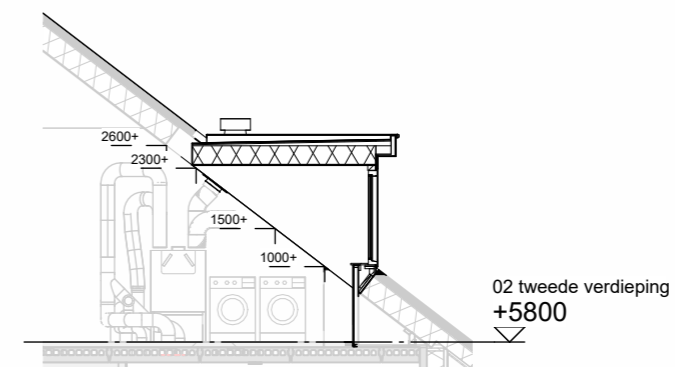

Doorsnede schaal 1:100



Dakkapel
achtergevel 130cm

Tekening: Dakkapel achtergevel 130cm

Woningtype: E60

Bouwnummer: -

Optienummer: 1.B.X.32

Bladformaat: A3

Schaal: 1:50 / 1:100

Datum: 21-04-2026

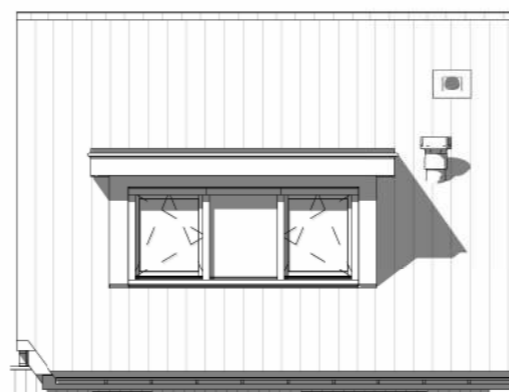
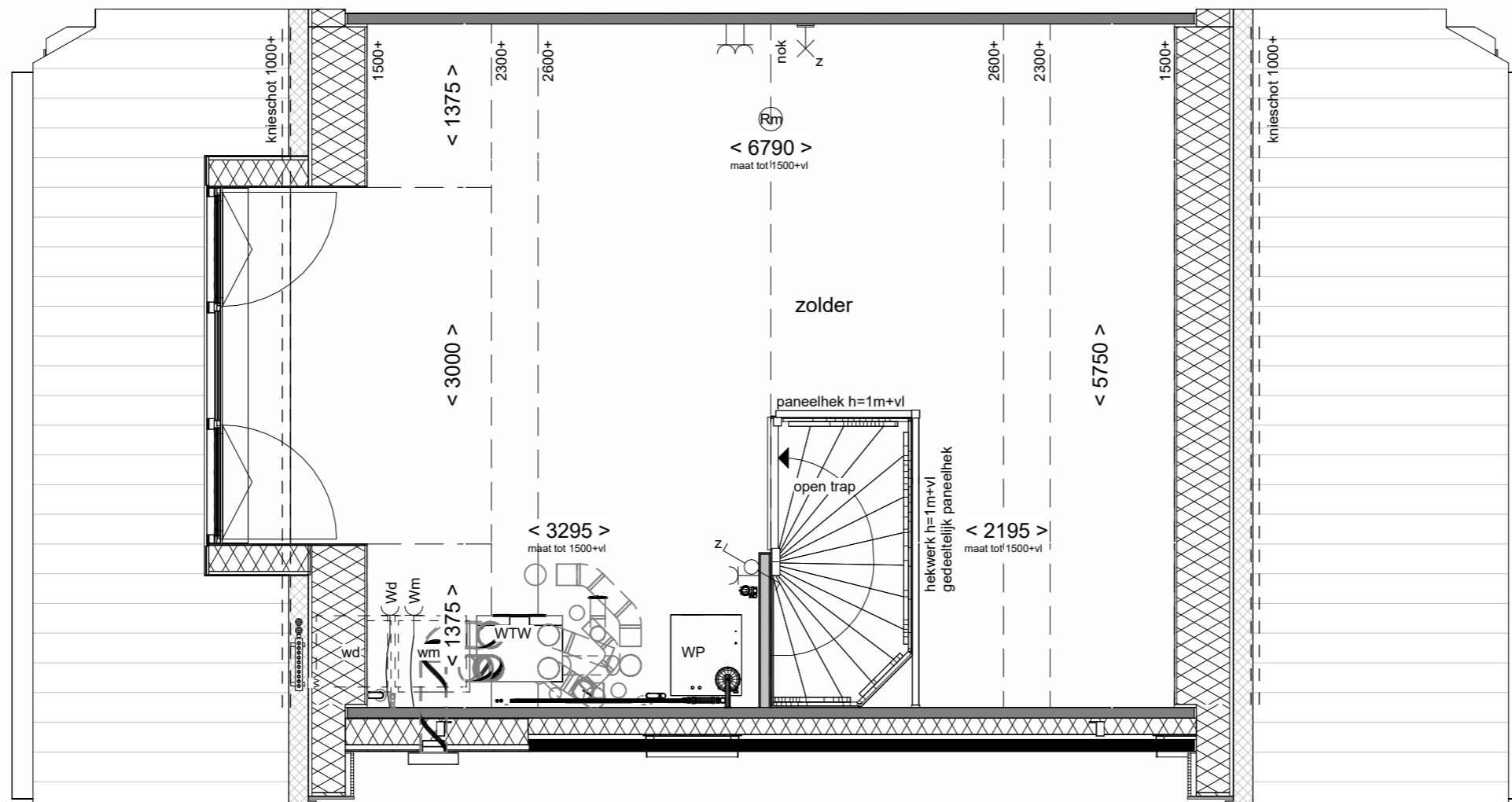

Achtergevel schaal 1:100

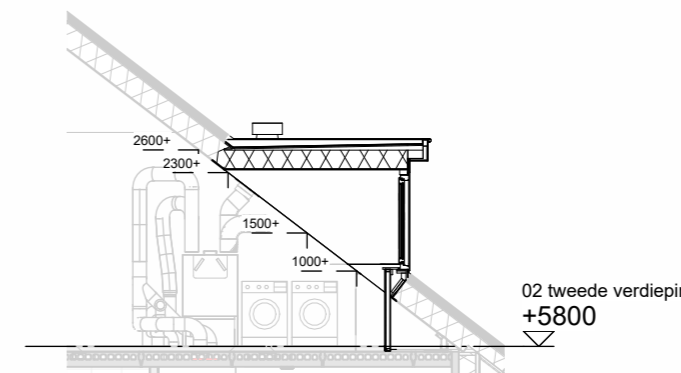

Doorsnede schaal 1:100



Dakkapel
achtergevel 300cm

Tekening: Dakkapel achtergevel 300cm

Woningtype: E60

Bouwnummer: -

Optienummer: 1.B.X.36

Bladformaat: A3

Schaal: 1:50 / 1:100

Datum: 21-04-2026

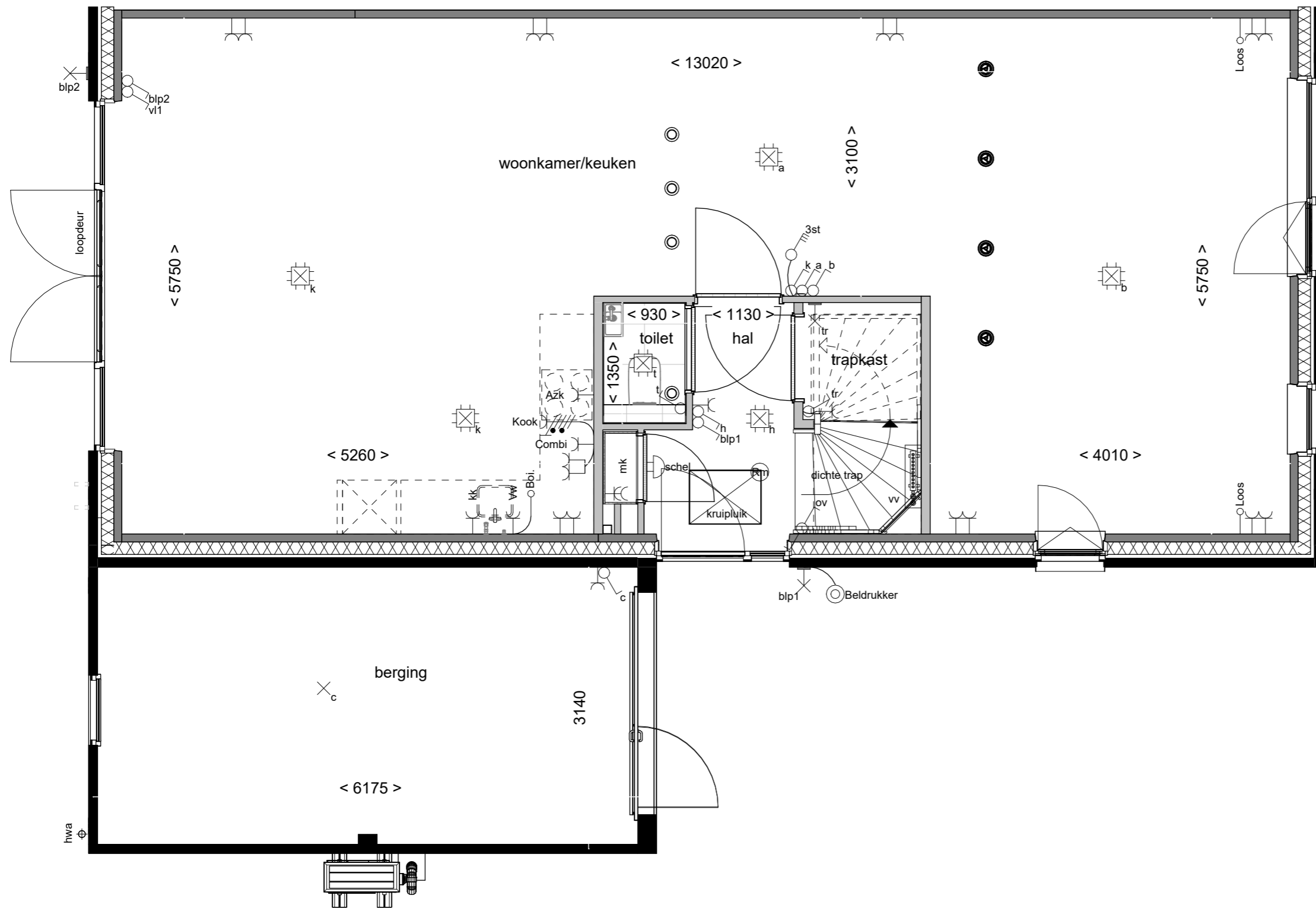

Tekening: Trapkast

Woningtype: E60

Bouwnummer: -

Optienummer: 1.C.E.10

Bladformaat: A3

Schaal: 1:50

Datum: 21-04-2026

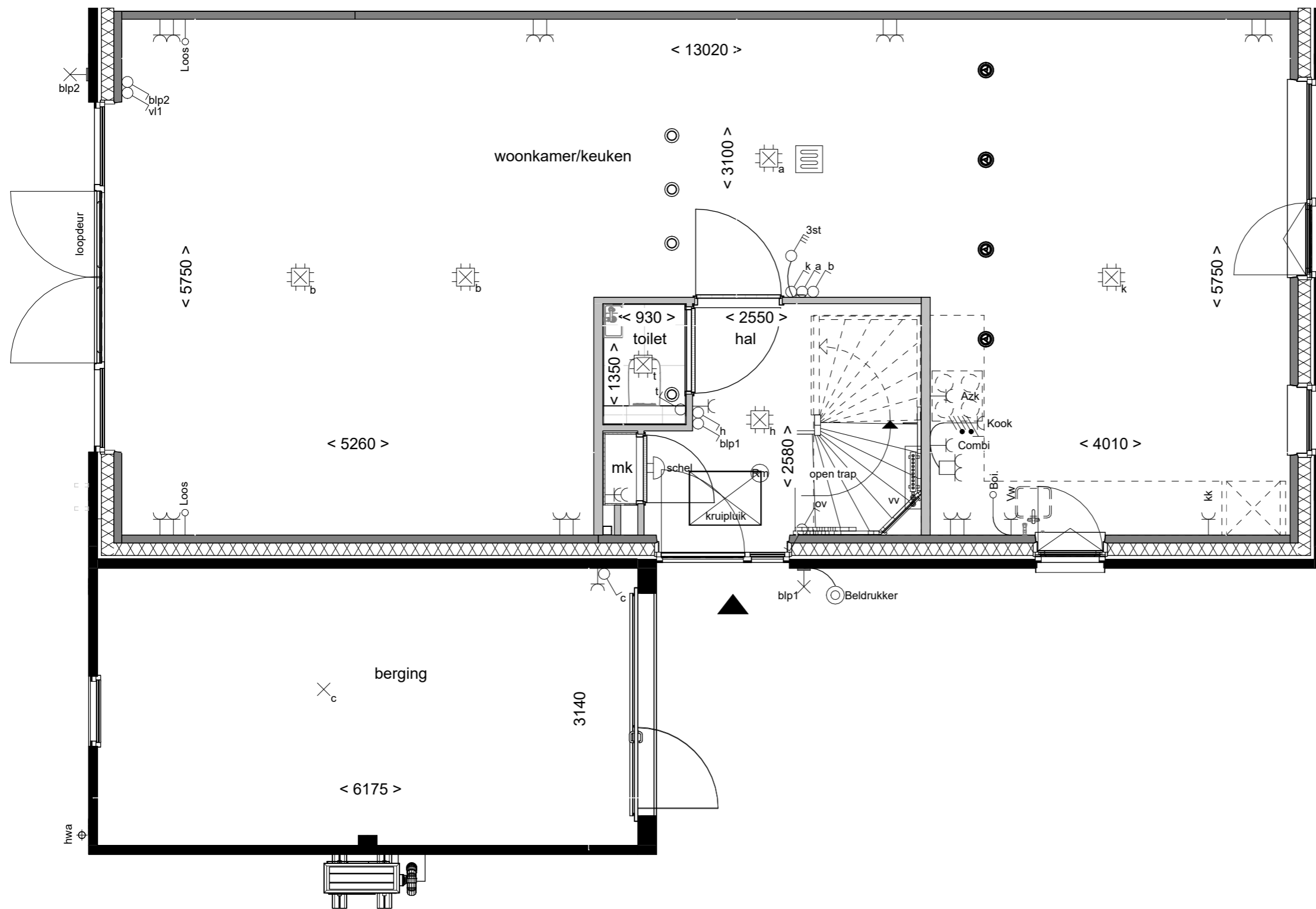

Tekening: Tuingericht wonen

Woningtype: E60

Bouwnummer: -

Optienummer: 1.C.E.12

Bladformaat: A3

Schaal: 1:50

Datum: 21-04-2026

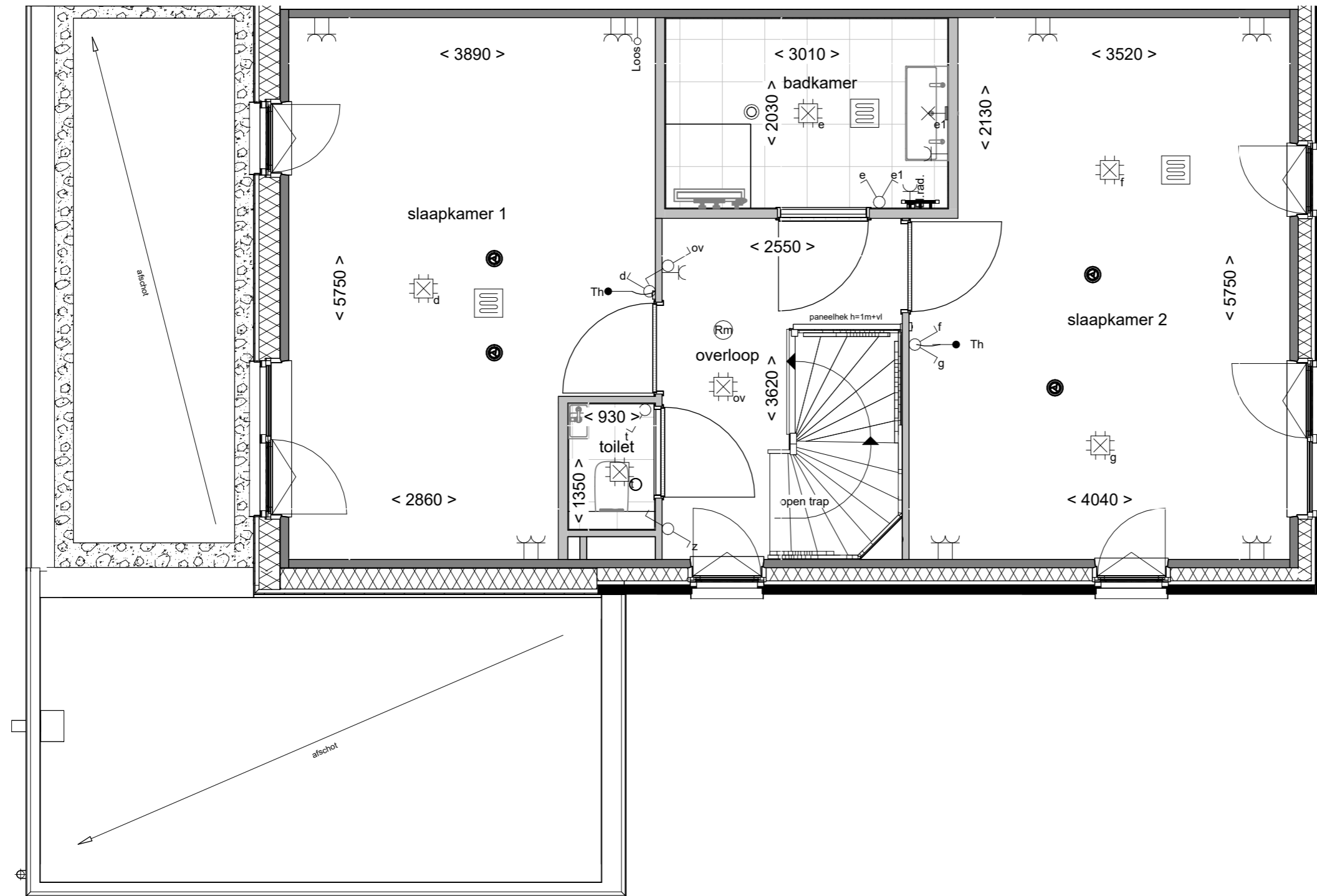

Samenvoegen
slaapkamers voor

Tekening: _____

Woningtype: E60

Bouwnummer: -

Optienummer: 1.C.E.30

Bladformaat: A3

Schaal: 1:50

Datum: 21-04-2026

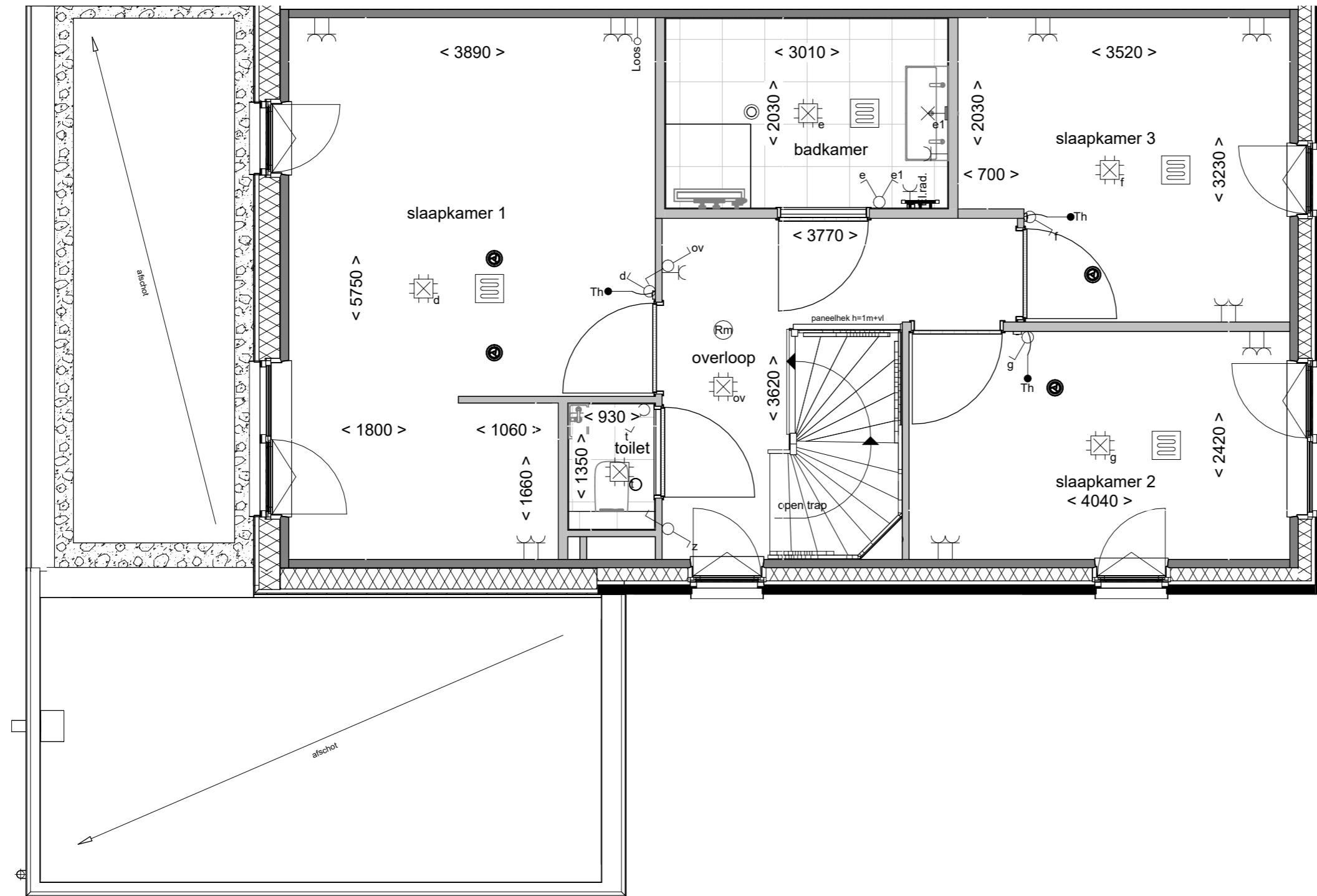

**Inloopkast in
slaapkamer achter**

Tekening: **Inloopkast in slaapkamer achter**

Woningtype: **E60**

Bouwnummer: **-**

Optienummer: **1.C.E.32**

Bladformaat: **A3**

Schaal: **1:50**

Datum: **21-04-2026**

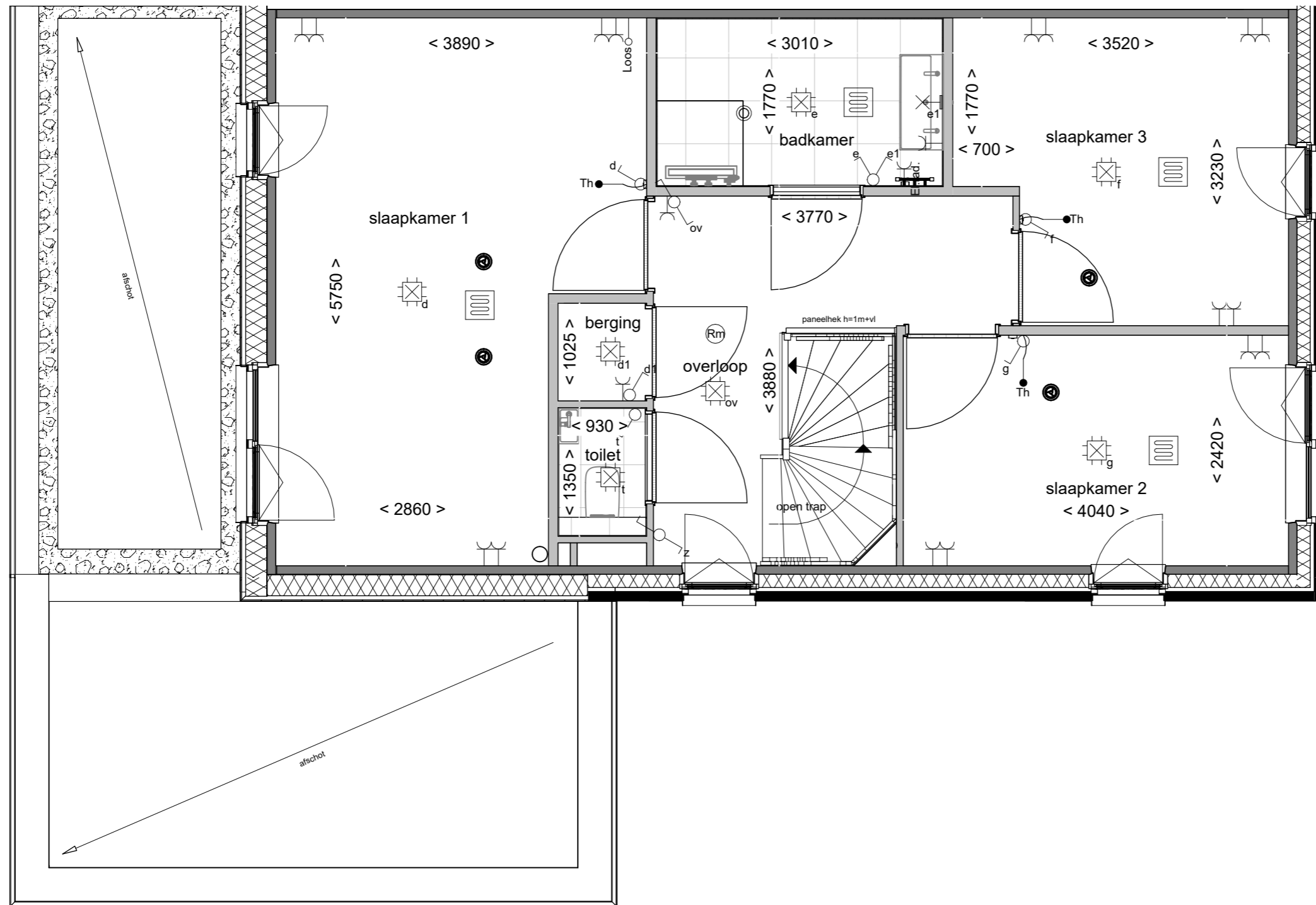

Vaste kast en compacte badk.

Tekening: _____

Woningtype: E60 _____

Bouwnummer: - _____

Optienummer: 1.C.E.34 _____

Bladformaat: A3 _____

Schaal: 1:50 _____

Datum: 21-04-2026 _____

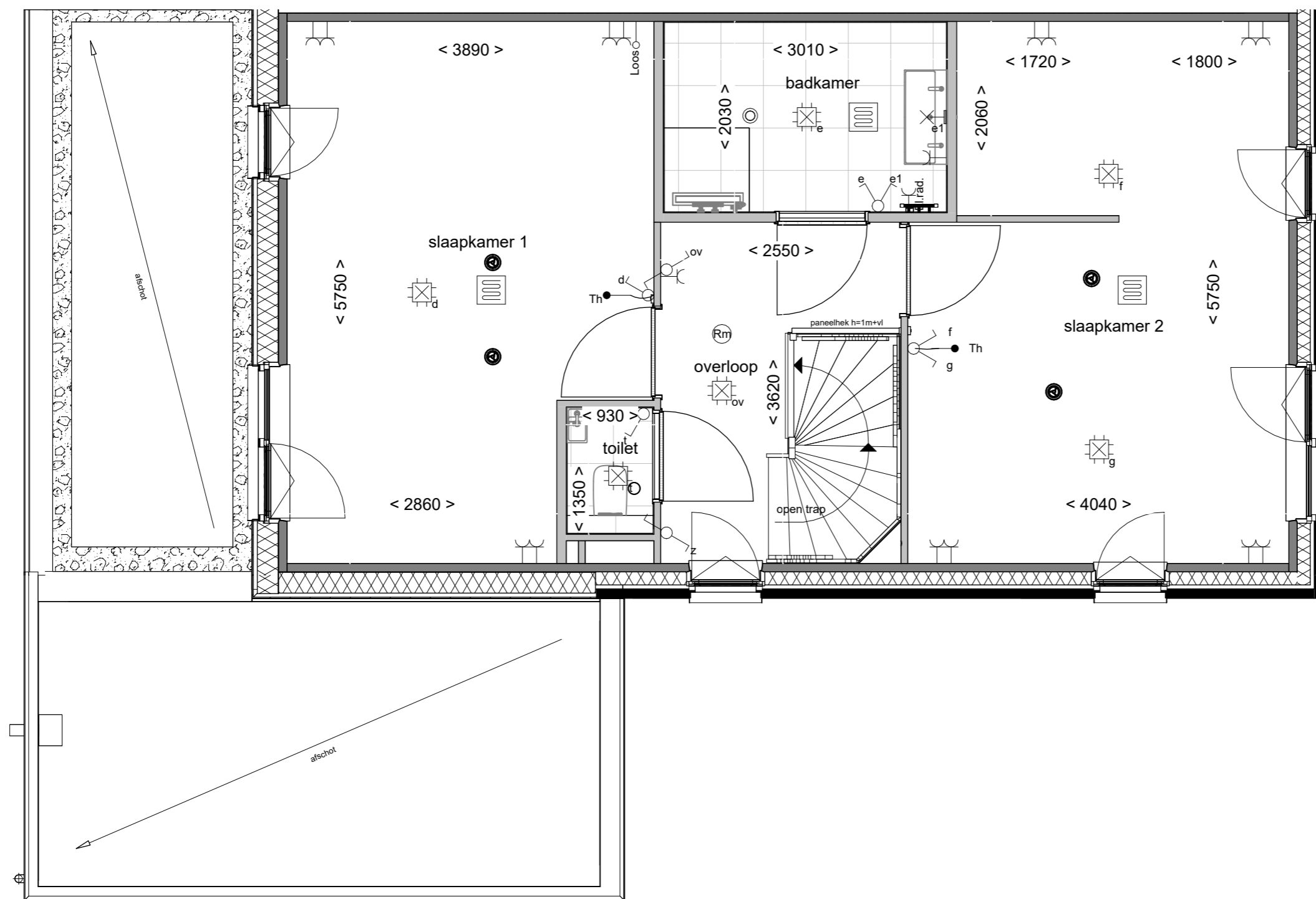

**Wonen aan
de Gantel**

Samenvoegen slpk
voor met inloopkast

Tekening: _____

Woningtype: E60

Bouwnummer: -

Optienummer: 1.C.E.36

Bladformaat: A3

Schaal: 1:50

Datum: 21-04-2026

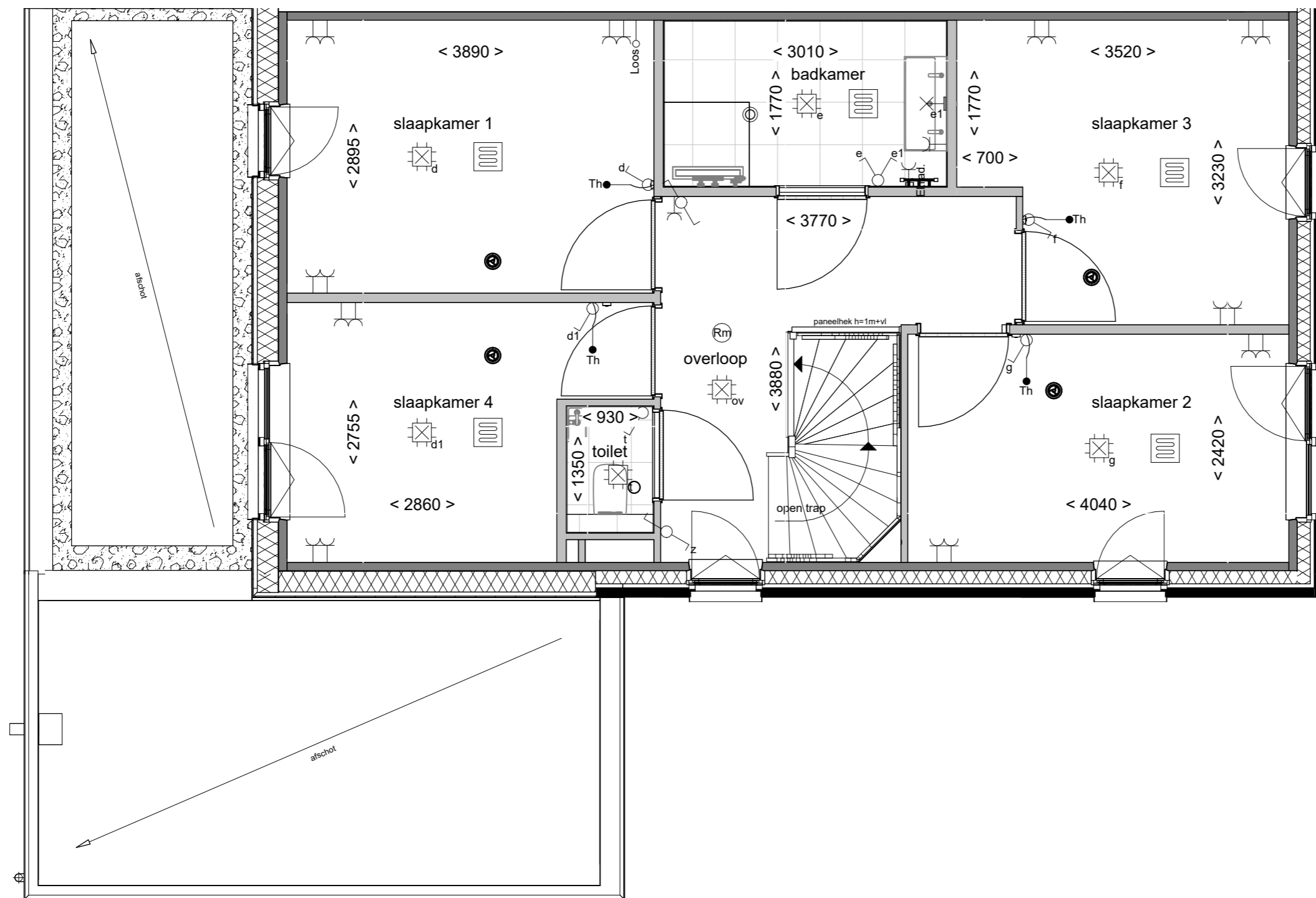

Compacte badk. met
4 slaapkamers

Tekening: 4 slaapkamers

Woningtype: E60

Bouwnummer: -

Optienummer: 1.C.E.38

Bladformaat: A3

Schaal: 1:50

Datum: 21-04-2026

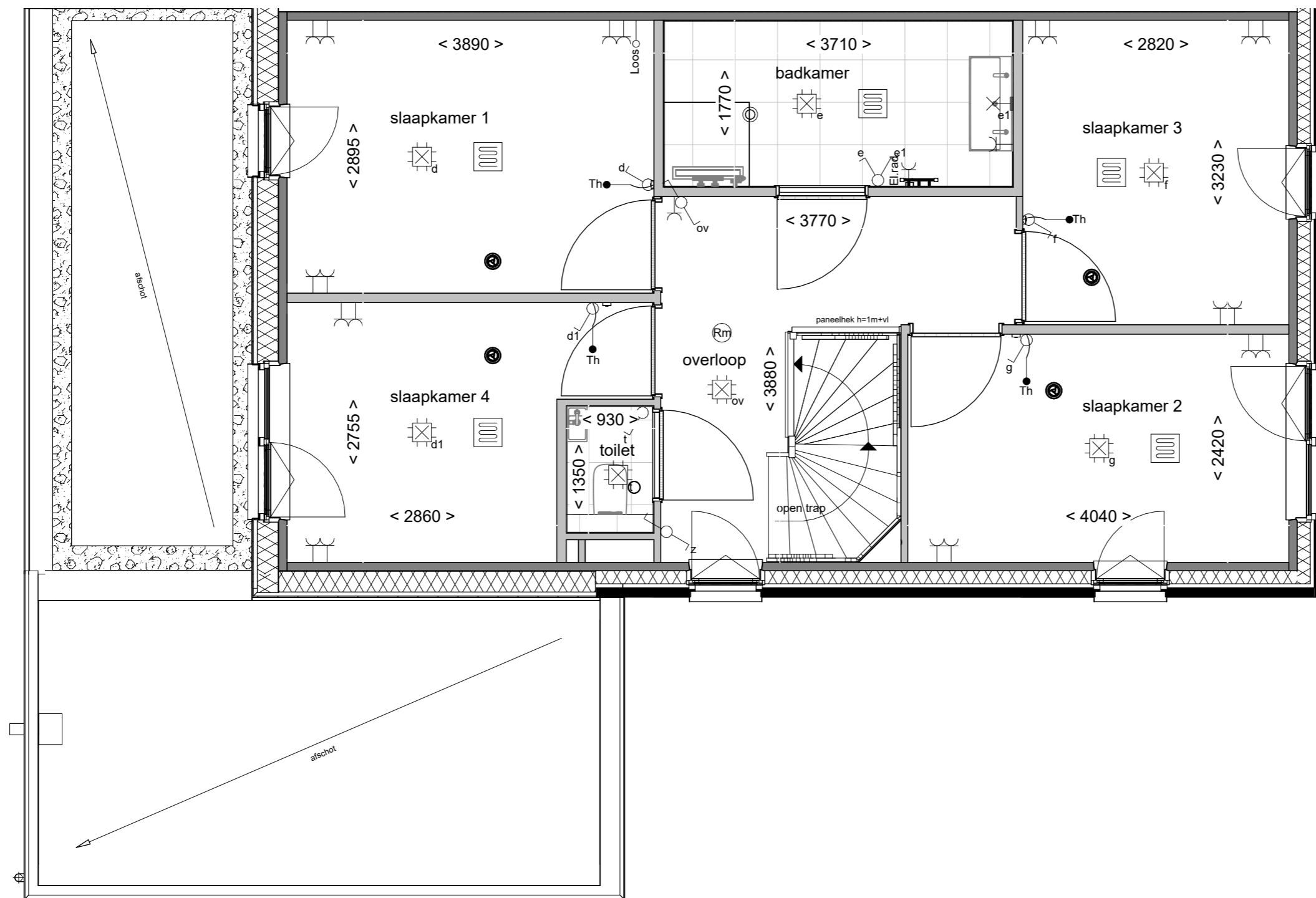

Verl. compacte badk.
met 4 slpk

Tekening:

Woningtype: E60

Bouwnummer: -

Optienummer: 1.C.E.40

Bladformaat: A3

Schaal: 1:50

Datum: 21-04-2026

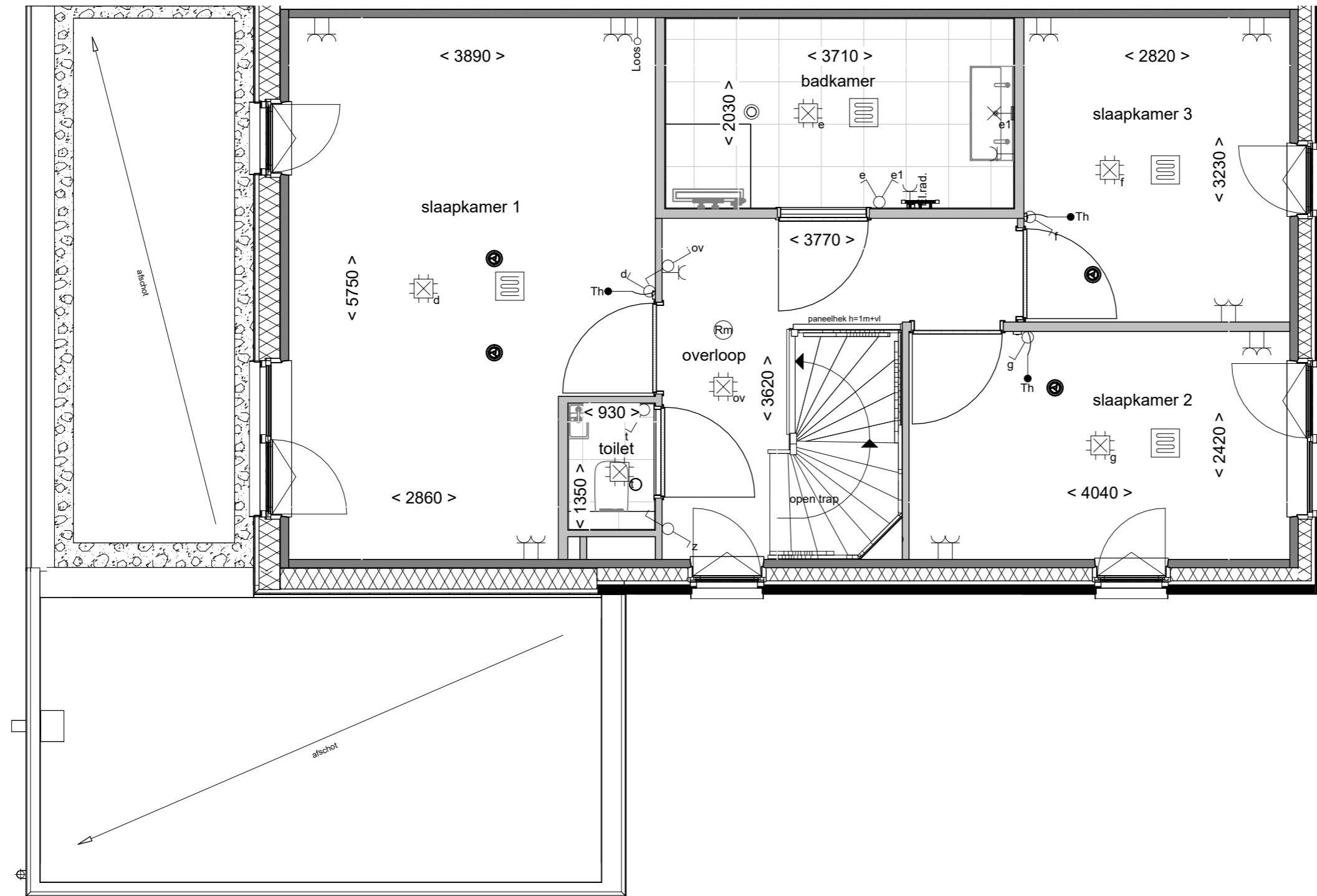

Tekening: **Badkamer vergroten**

Woningtype: **E60**

Bouwnummer: **-**

Optienummer: **1.C.E.42**

Bladformaat: **A3**

Schaal: **1:50**

Datum: **21-04-2026**

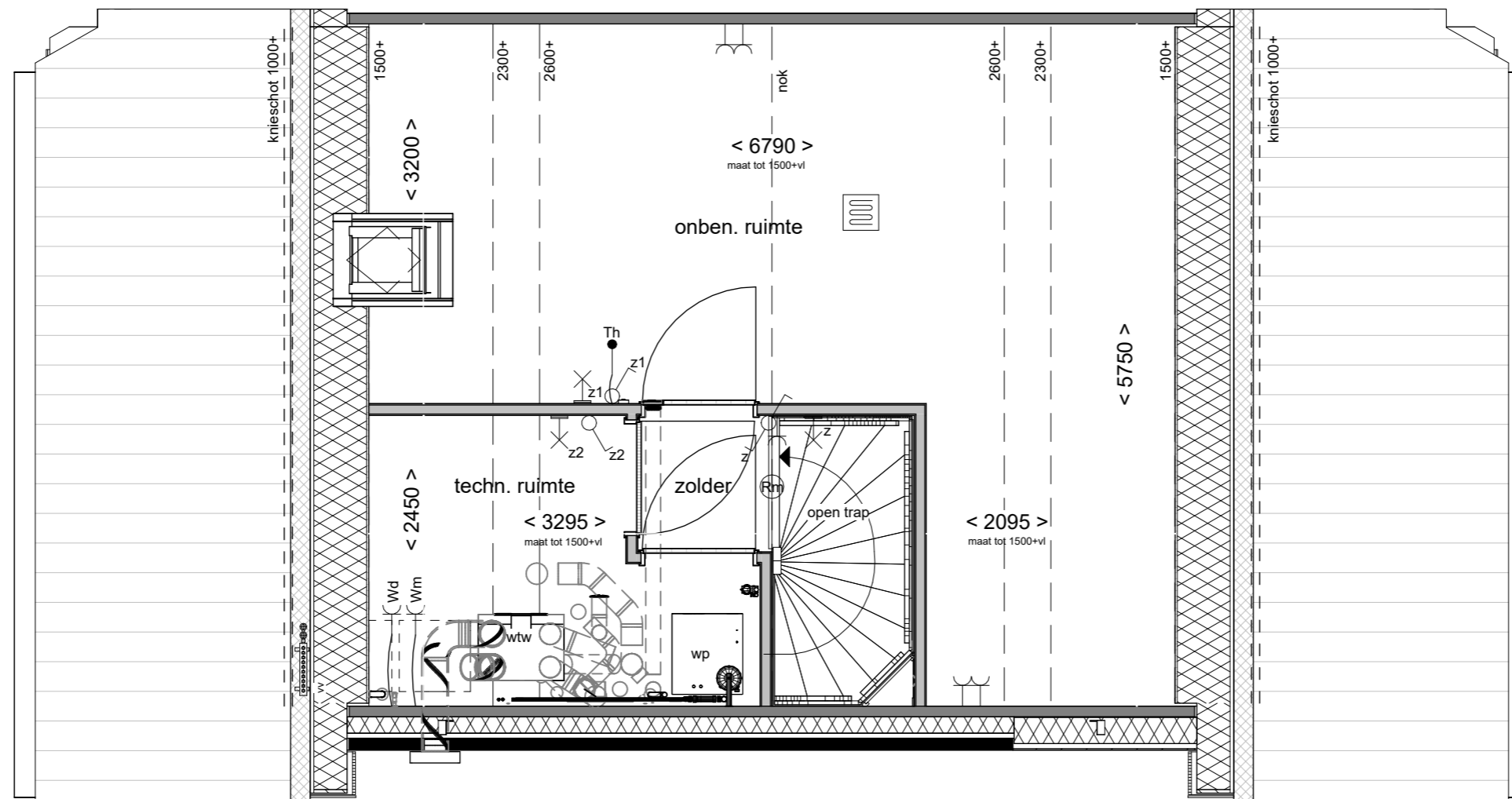

**Wonen aan
de Gantel**

Indeling met 1
onben. ruimte

Tekening:

Woningtype: E60

Bouwnummer: -

Optienummer: 1.C.E.74

Bladformaat: A3

Schaal: 1:50

Datum: 21-04-2026

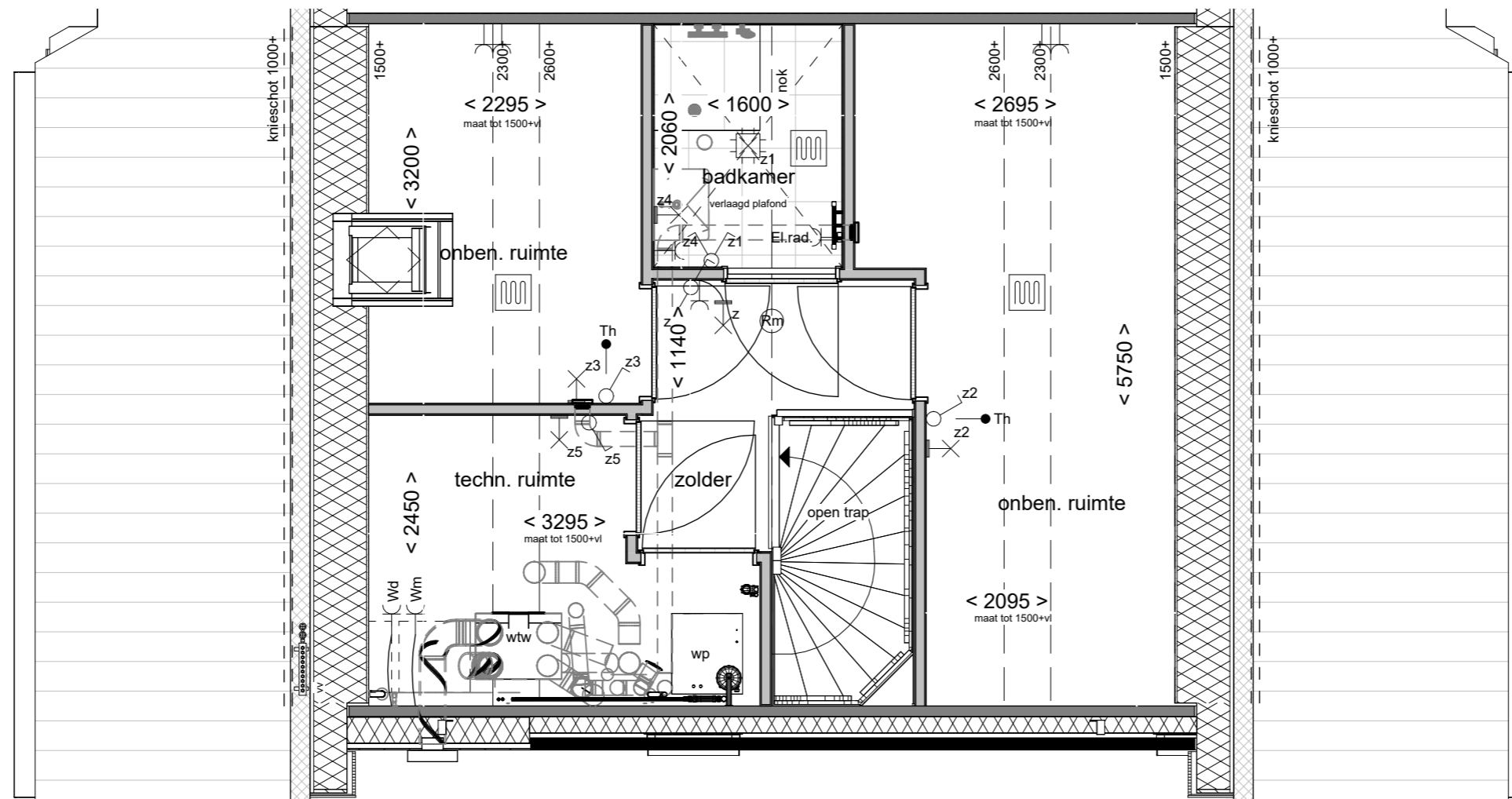

**Wonen aan
de Gantel**

Tekening: **Indeling 2 ruimten en badkamer**

Woningtype: **E60**

Bouwnummer: **-**

Optienummer: **1.C.E.78**

Bladformaat: **A3**

Schaal: **1:50**

Datum: **21-04-2026**

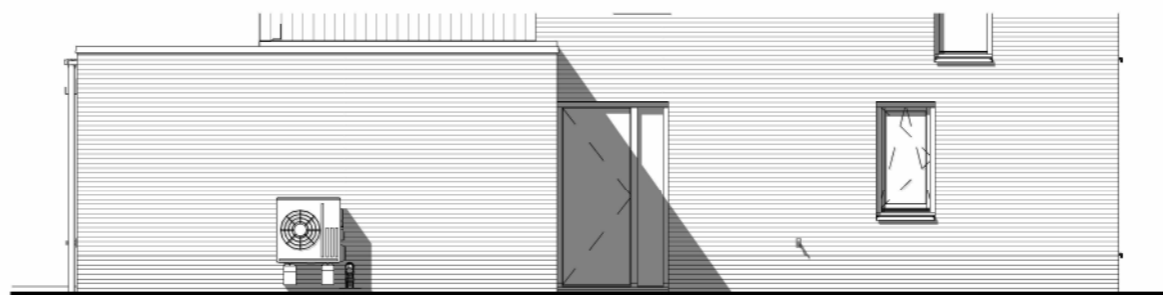
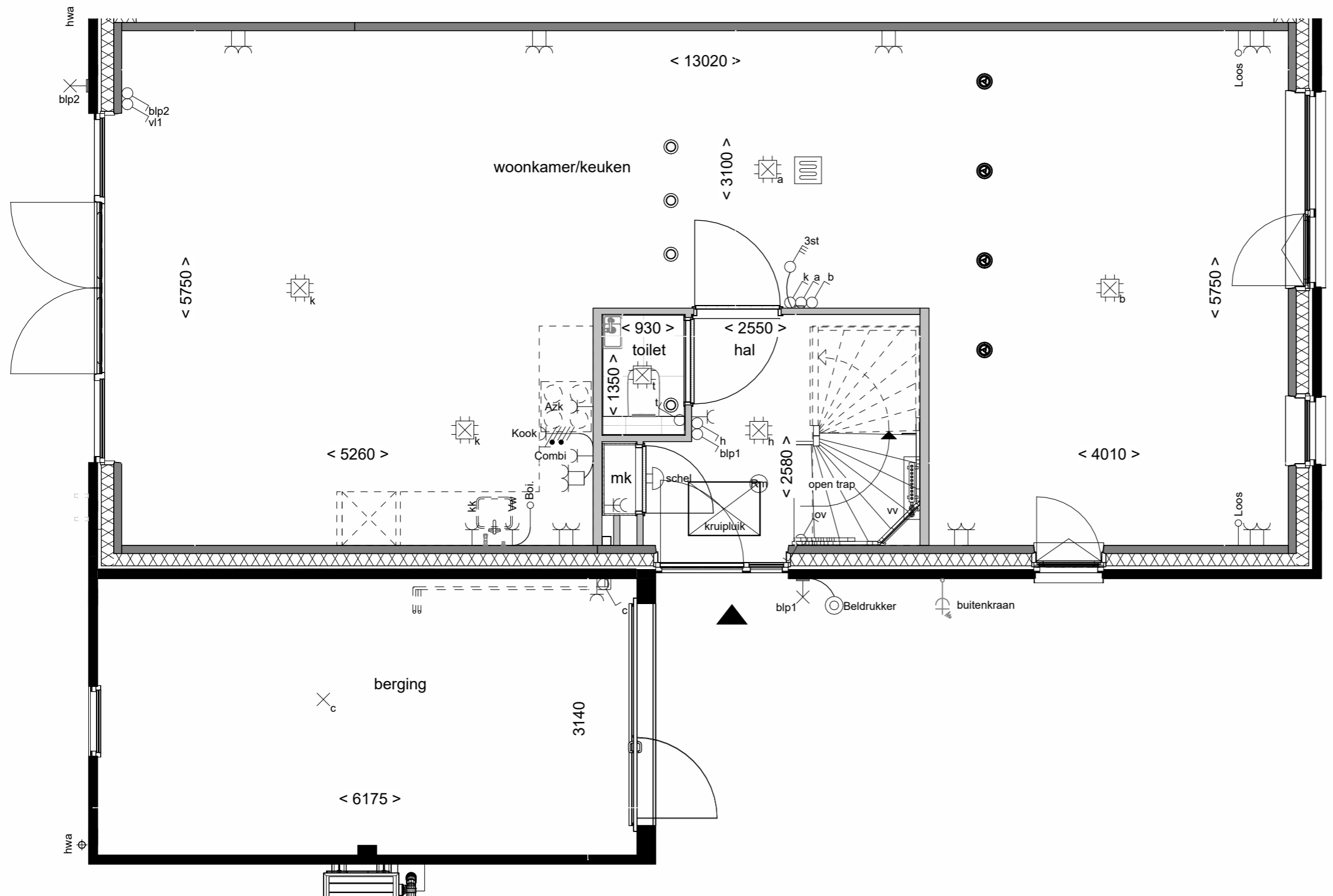

Linkerzijgevel schaal 1:100



vorstvrij buitenkraan
naast voordeur

Tekening:	
Woningtype:	E60
Bouwnummer:	02-07,10-13,16,17
Optienummer:	2.K.0.40
Bladformaat:	A3
Schaal:	1:50 / 1:100
Datum:	21-04-2026

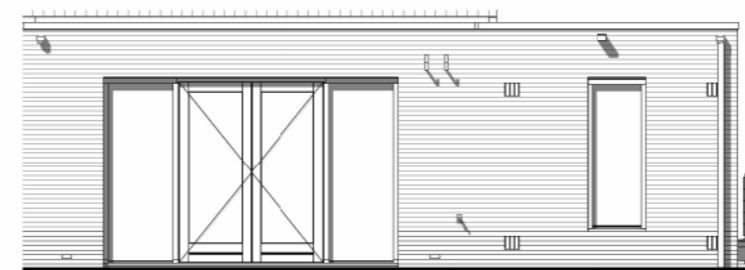
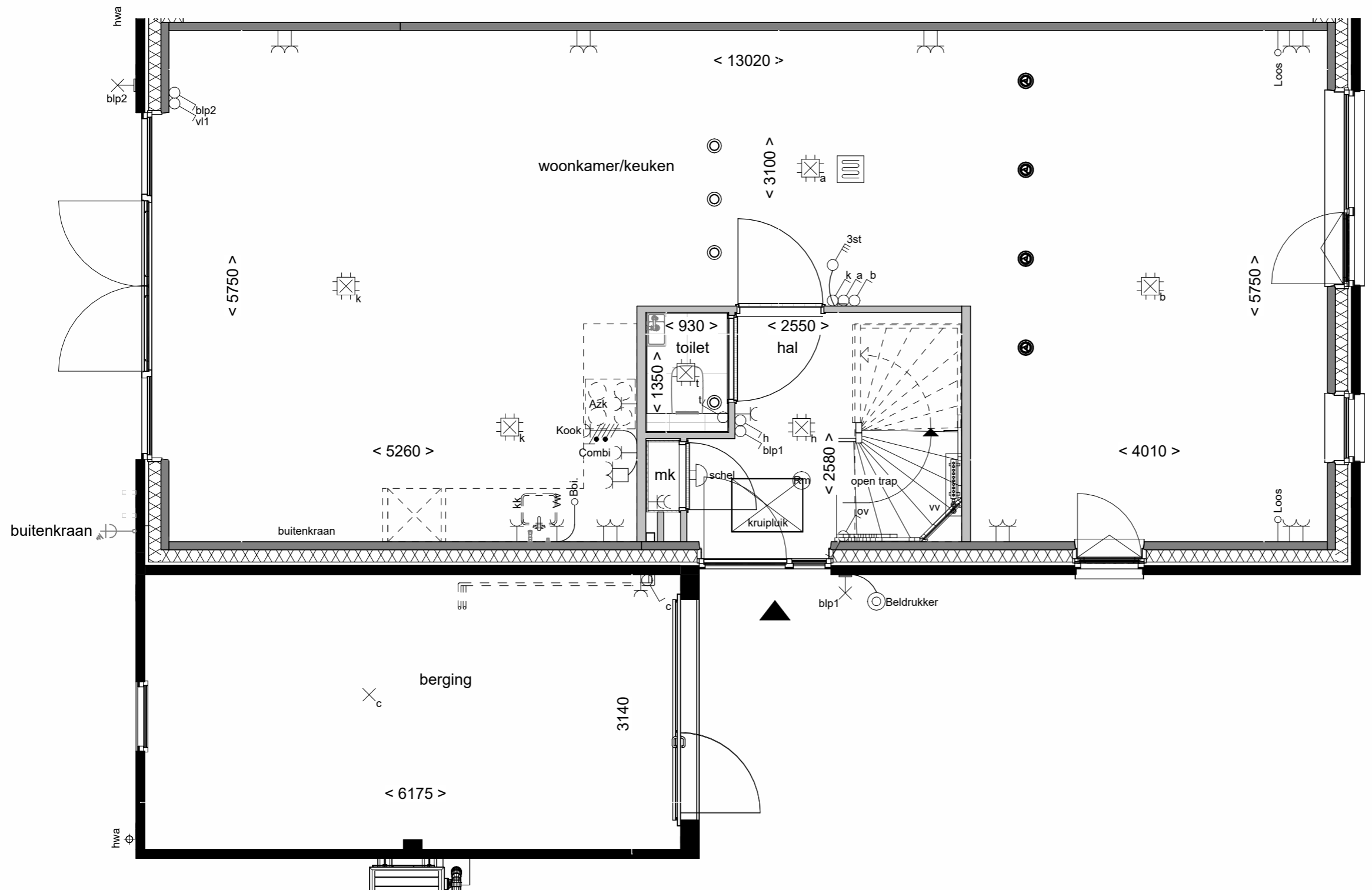

Achtergevel schaal 1:100



vorstvrij buitenkraan
achter

Tekening:	
Woningtype:	E60
Bouwnummer:	02-07,10-13,16,17
Optienummer:	2.K.0.44
Bladformaat:	A3
Schaal:	1:50 / 1:100
Datum:	21-04-2026

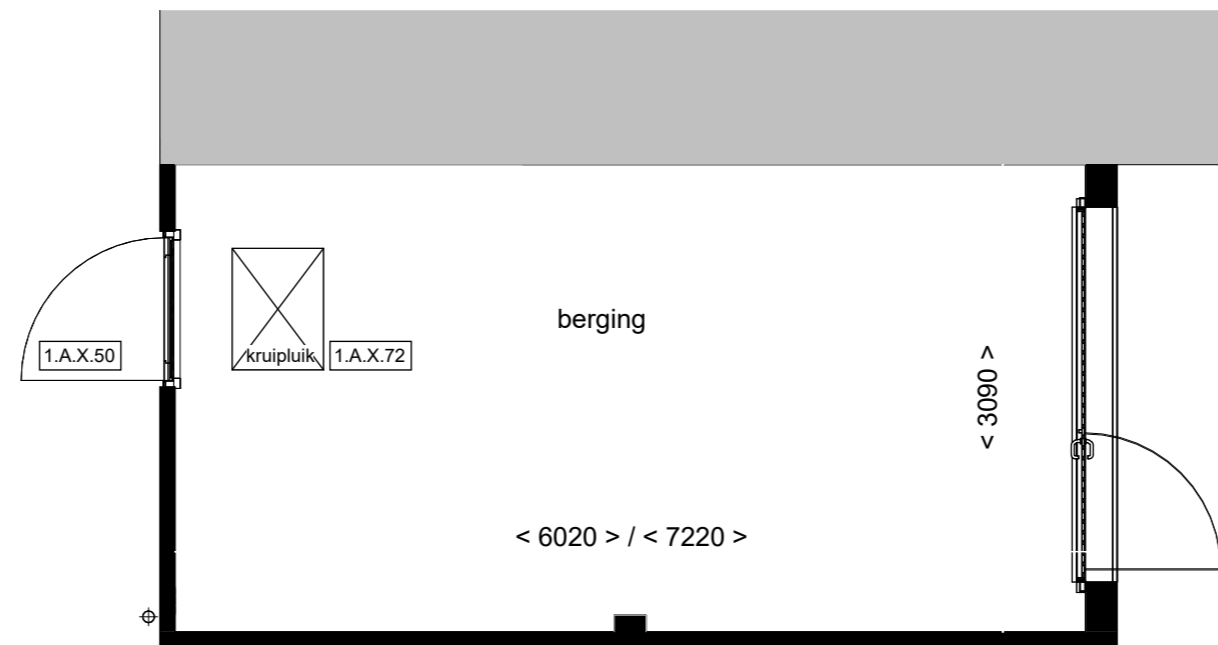

**Wonen aan
de Gantel**

**Kruipluik in de
berging**

Tekening:

Woningtype: E60/F60/F60+/F60D

Bouwnummer: 1 t/m 20

Optienummer: 1.A.X.50 / 1.A.X.72

Bladformaat: A3

Schaal: 1 : 50

Datum: 21-04-2026

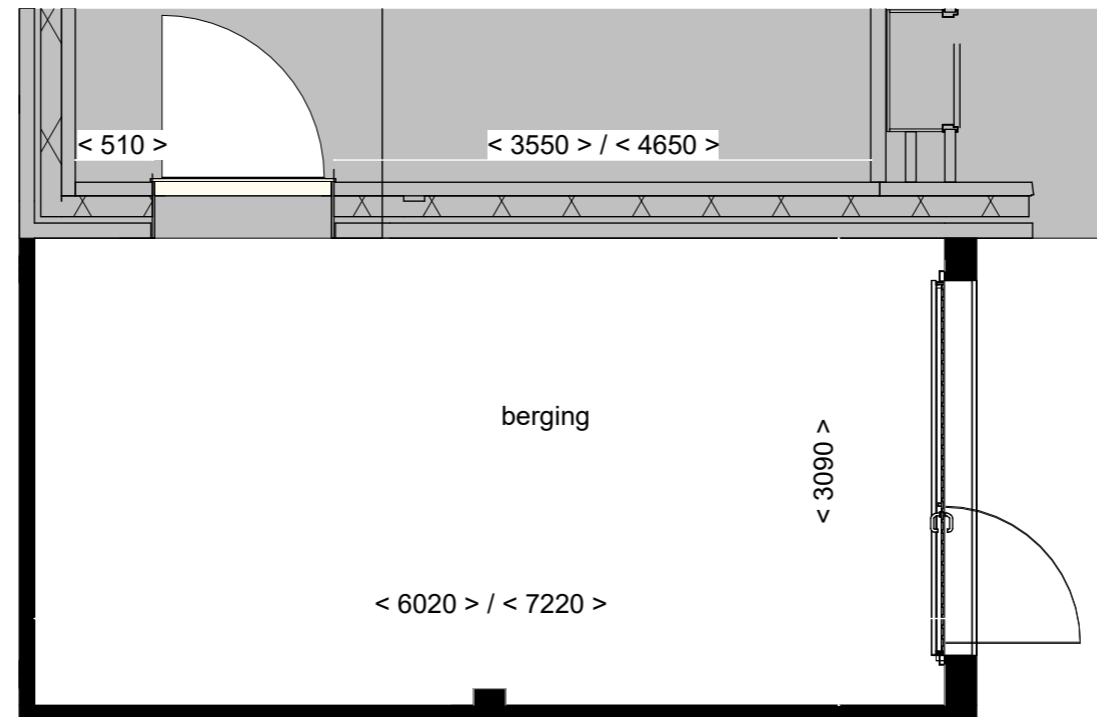

Tekening: Buitendeur tussen woning en berging

Woningtype: E60/F60/F60+

Bouwnummer: 1 t/m 19

Optienummer: 1.A.X.74 B

Bladformaat: A3

Schaal: 1 : 50

Datum: 21-04-2026

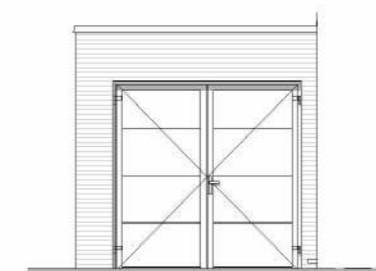
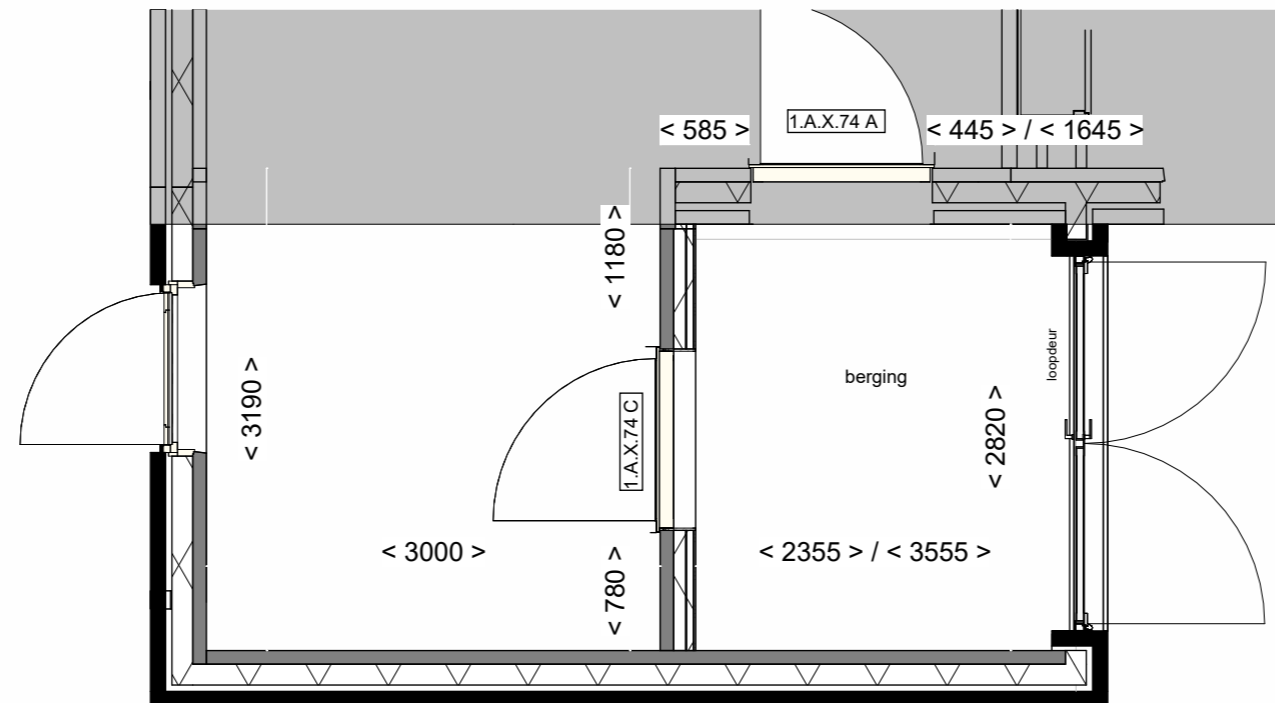

Voorgevel schaal 1:100



Buitendeur tussen
woning en berging

Tekening:

Woningtype: E60/F60/F60+

Bouwnummer: 1 t/m 19

Optienummer: 1.A.X.74 C

Bladformaat: A3

Schaal: 1:50

Datum: 21-04-2026

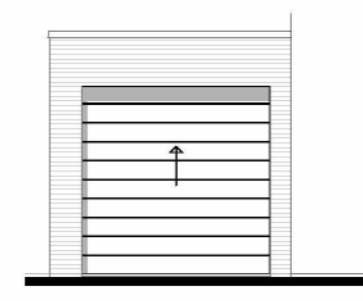
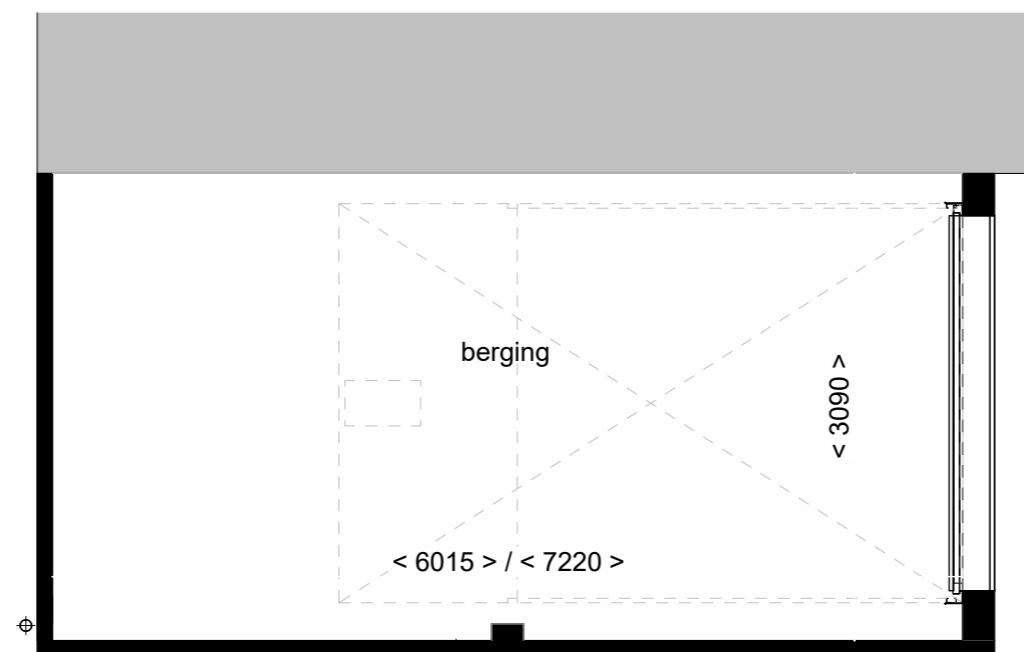

Voorgevel schaal 1:100



**Wonen aan
de Gantel**

Sectionaaldeur ipv
kanteldeur

Tekening:

Woningtype: E60/F60/F60+/F60D

Bouwnummer: 1 t/m 20

Optienummer: 1.A.X.80

Bladformaat: A3

Schaal: 1:50

Datum: 21-04-2026

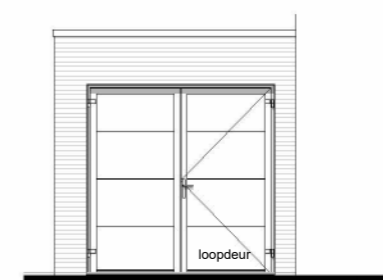
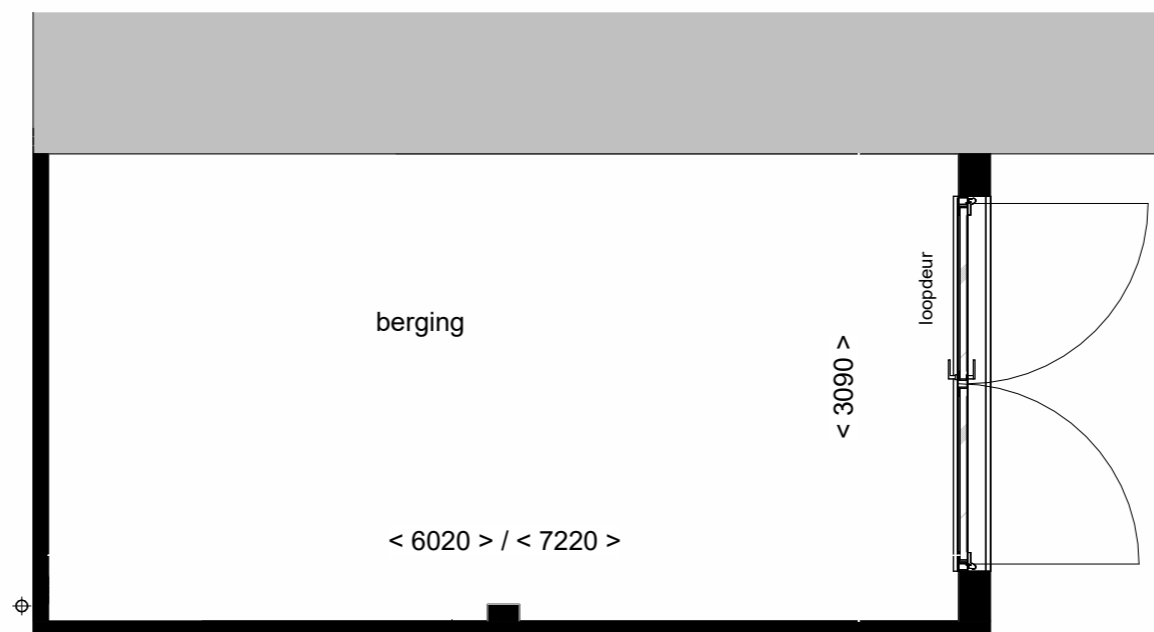

Voorgevel schaal 1:100



**Wonen aan
de Gantel**

Dubbele
openslaande deuren

Tekening: **Dubbele openslaande deuren**

Woningtype: **E60/F60/F60+/F60D**

Bouwnummer: **1 t/m 20**

Optienummer: **1.A.X.84**

Bladformaat: **A3**

Schaal: **1:50**

Datum: **21-04-2026**

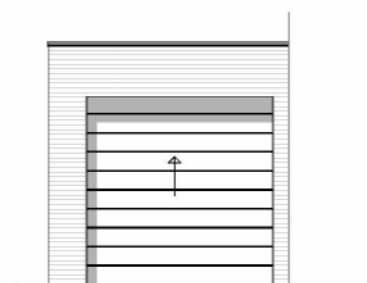
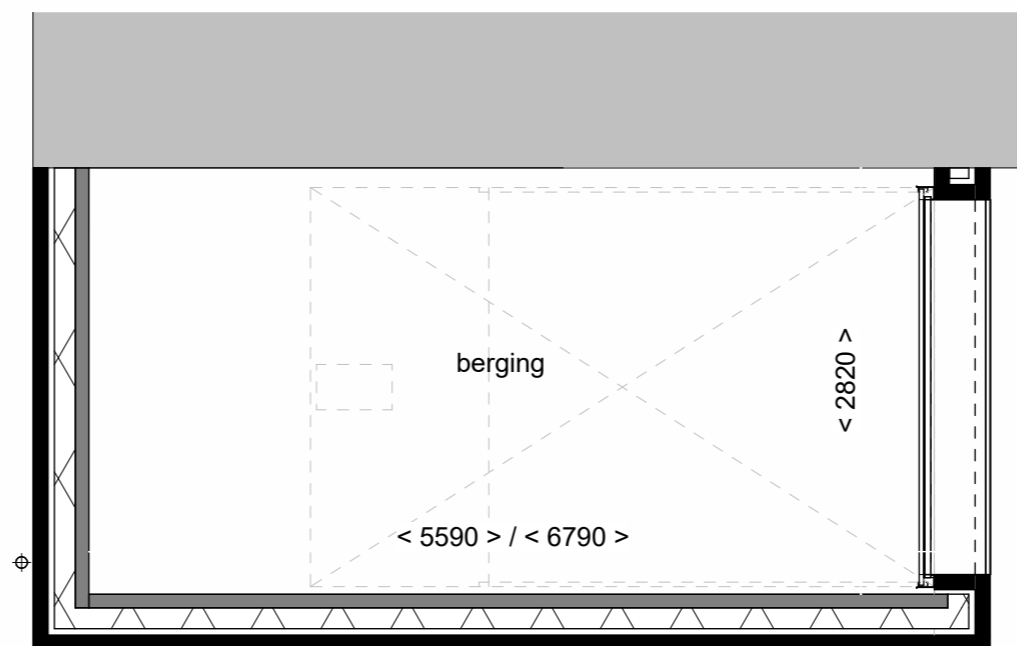

Voorgevel schaal 1:100



Achtergevel schaal 1:100



**Wonen aan
de Gantel**

Tekening: **Isoleren berging**

Woningtype: **E60/F60/F60+/F60D**

Bouwnummer: **01 t/m 20**

Optienummer: **1.A.X.86**

Bladformaat: **A3**

Schaal: **1:50**

Datum: **21-04-2026**

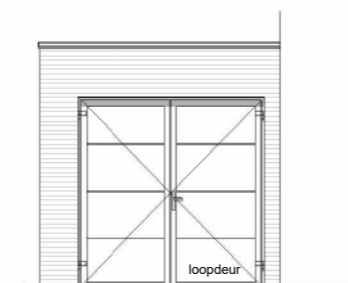
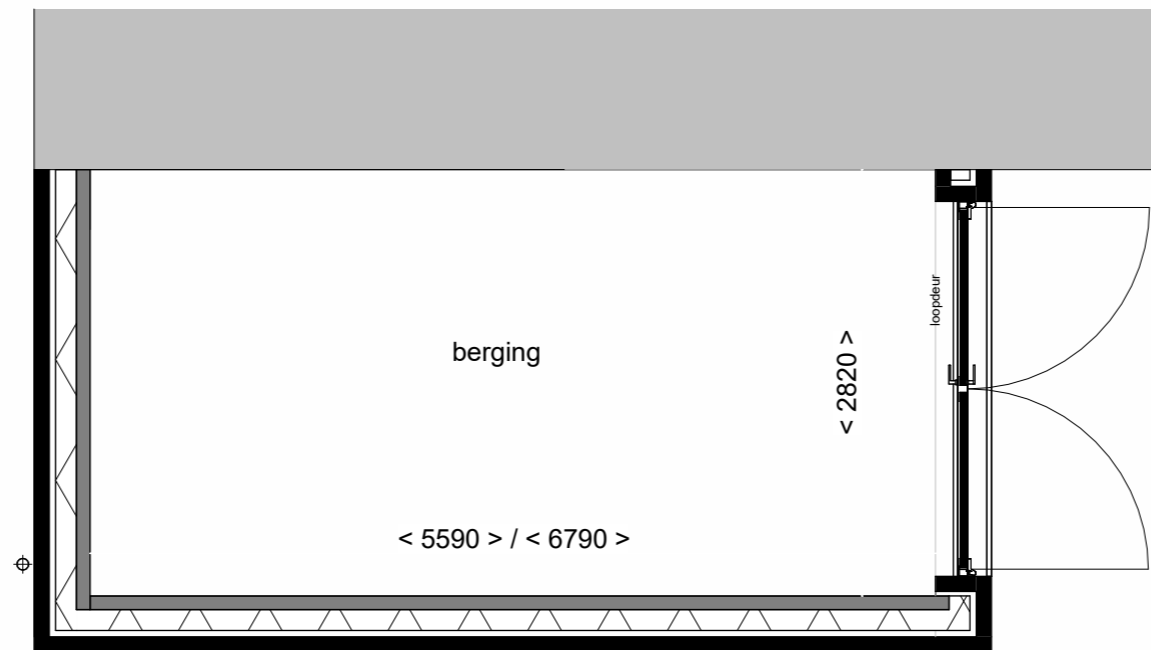

Voorgevel schaal 1:100



Achtergevel schaal 1:100



**Wonen aan
de Gantel**

Dubbele deuren,
isoleren

Tekening:

Woningtype: E60/F60/F60+/F60D

Bouwnummer: 1 t/m 20

Optienummer: 1.A.X.94

Bladformaat: A3

Schaal: 1:50

Datum: 21-04-2026