

### Renvooi

-  - entree woongebouw
-  - erfgrans
-  - parkeervak eigen terrein
-  - parkeervak openbaar
-  - houten vlonder
-  - pergola
-  - haag laag
-  - haag hoog
-  - water
-  - openbaar groen
-  - wandelpad houtsnippers
-  - voetpad
-  - inrit
-  - straat
-  - talud
-  - boom, positie in overleg met koper
-  - indicatie positie riolering
-  - zone erfdienstbaarheid
-  - klinkerbestrating

### parkeerplekken en posities bomen indicatief

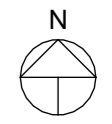

Tekening: **Situatie totaal**

---

Woningtype: **E60,E60D,F60,F60+**

---

Bouwnummer: **1 t/m 31**

---

Bladnummer: **VT-S-00**

---

Bladformaat: **A3**

---

Schaal: **1:750**

---

Datum: **21-04-2026**

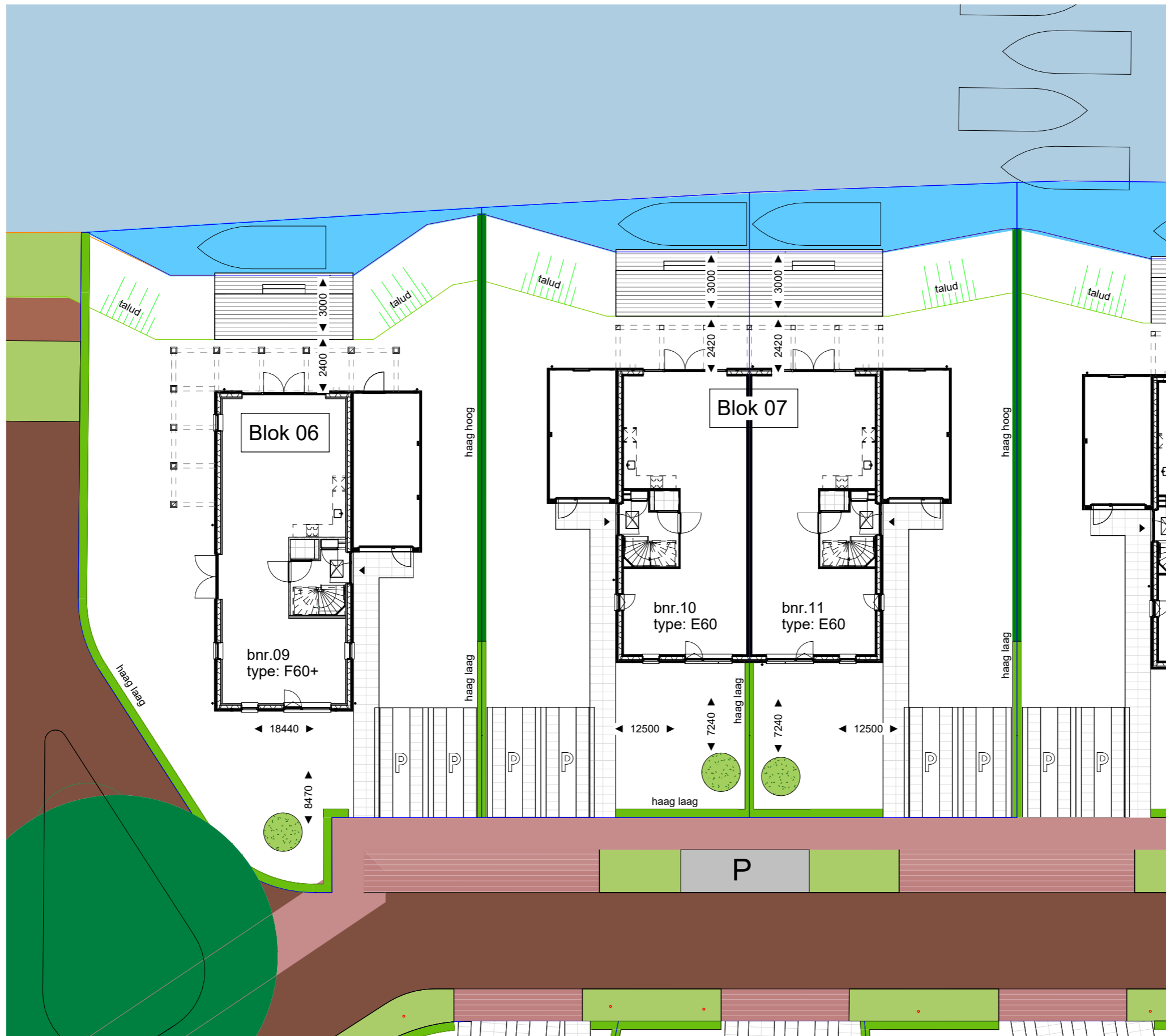

### Renvooi

-  - entree woongebouw
-  - erfgrens
-  - parkeervak eigen terrein
-  - parkeervak openbaar
-  - houten vlonder
-  - pergola
-  - haag laag
-  - haag hoog
-  - water
-  - openbaar groen
-  - wandelpad houtsnippers
-  - voetpad
-  - straat
-  - talud
-  - boom, positie in overleg met koper
-  - indicatie positie riolering
-  - zone erfdienstbaarheid
-  - klinkerbestrating

### parkeerplekken en posities bomen indicatief



Tekening: **Situatie bnr. 9-11**

Woningtype: **E60, E60D, F60+**

Bouwnummer: **9, 10, 11**

Bladnummer: **VT-S-03**

Bladformaat: **A3**









Schaal: **1:200**

Datum: **21-04-2026**

## Renvooi materialen

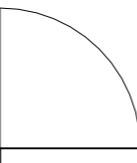
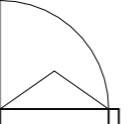
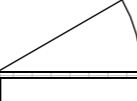
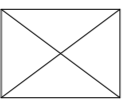
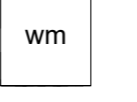
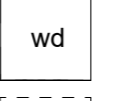
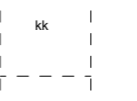
	dakpan antracietgrijs
	metselwerk kleur grijswit gesinterd code A: EN1166 WF WS
	metselwerk kleur bruin nuance code B: HM1106 WF WS
	metselwerk kleur bruin caramel code C: EN1165 WF WS
	gevelbetimmering vuren vergrijsd

## Renvooi bouwkundig

	entree woning
	metselwerk
	isolatie
	dragende wand
	niet dragende binnenwand
	buitendeur
	draairaam
	binnendeurkozijn (met bovenlicht)
	kruipluik
	opstelplaats wasmachine
	opstelplaats wasdroger
	opstelplaats koelkast
	principe opstelling keukenblok
	
	onbenoemde ruimte volgens krijtstreepmethode

## Renvooi installaties

	aansluitpunt licht, wand
	centraaldoos met lichtpunt
	armatuur aan de wand
	rookmelder
	aansluitpunt niet bedraad / loos
	aansluitpunt bedraad data, niet afgemonteerd
	beldrukker
	schel
	schakelaar, 1-polig
	werkschakelaar tbv PV-panelen
	driestandenschakelaar tbv wtw
	schakelaar, wissel
	schakelaar, serie
	pulsschakelaar tbv warmteterugwinunit
	wandcontactdoos 1-voudig met beschermingscontact
	wandcontactdoos 2-voudig met beschermingscontact
	thermostaatleiding, bedraad
	wandcontactdoos tbv warmteterugwinunit
	wtw mechanische ventilatie-unit incl. warmteterugwinunit
	wp warmtepomp
	inblaasventiel mechanische ventilatie
	afzuigventiel mechanische ventilatie
	vv verdeler vloerverwarming
	ruimte vzv vloerverwarming
	rad elektrische radiator
	kanalen in het zicht
	doucheput
	lijngoot douche
	buitenkraan

### Disclaimer

De op deze tekeningen aangegeven maten zijn circa maten in millimeters en tussen de wanden / vloeren gemeten, waarbij geen rekening is gehouden met enige wandafwerking, plinten, aftimmering, etc. In verband met de nauwkeurige uitwerking van details, constructie, maatvoering, materialen e.d. kunnen er kleine afwijkingen ontstaan ten opzichte van de nu vermelde gegevens. Deze geringe afwijkingen geven geen aanleiding tot verrekening. Aan de op deze tekening aangegeven maten kunnen derhalve geen rechten worden ontleend. De op deze tekeningen aangegeven maatvoering is niet geschikt voor opdrachten aan derden door koper(s). De posities van aansluitingen en installatie onderdelen zijn indicatief op tekening aangegeven. De exacte aantallen en posities zullen na berekening in het werk door de installateurs worden bepaald en kunnen afwijken van deze tekening.



Tekening: Renvooi

Woningtype: E60 / F60 / F60+

Bouwnummer: 1 t/m 31

Bladnummer: VT-0-00c

Bladformaat: A3

Schaal: 1 : 50

Datum: 21-04-2026



Vorgevel

Type: E60D  
bnr: 10

Type: E60  
bnr: 11

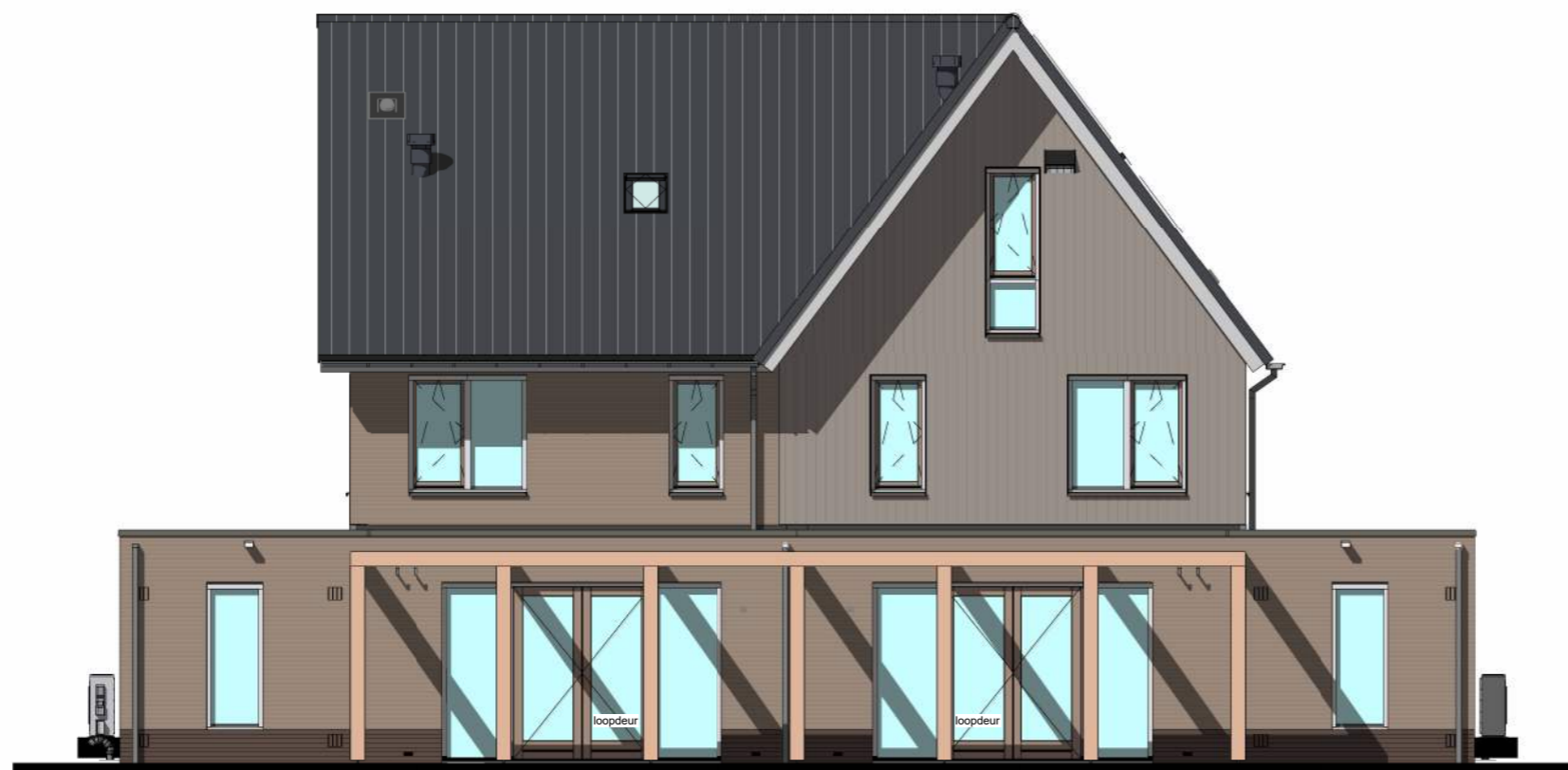

Achtergevel

Type: E60  
bnr: 11

Type: E60D  
bnr: 10



Tekening: Gevels blok 7

Woningtype: E60D / E60

Bouwnummer: 10 / 11

Bladnummer: VT-07-00a

Bladformaat: A3

Schaal: 1 : 100

Datum: 21-04-2026



Linker zijgevel

Type: E60D  
bnr: 10



Rechter zijgevel

Type: E60  
bnr: 11



Tekening: Zijgevels blok 7

Woningtype: E60D / E60

Bouwnummer: 10 / 11

Bladnummer: VT-07-00b

Bladformaat: A3

Schaal: 1 : 100

Datum: 21-04-2026

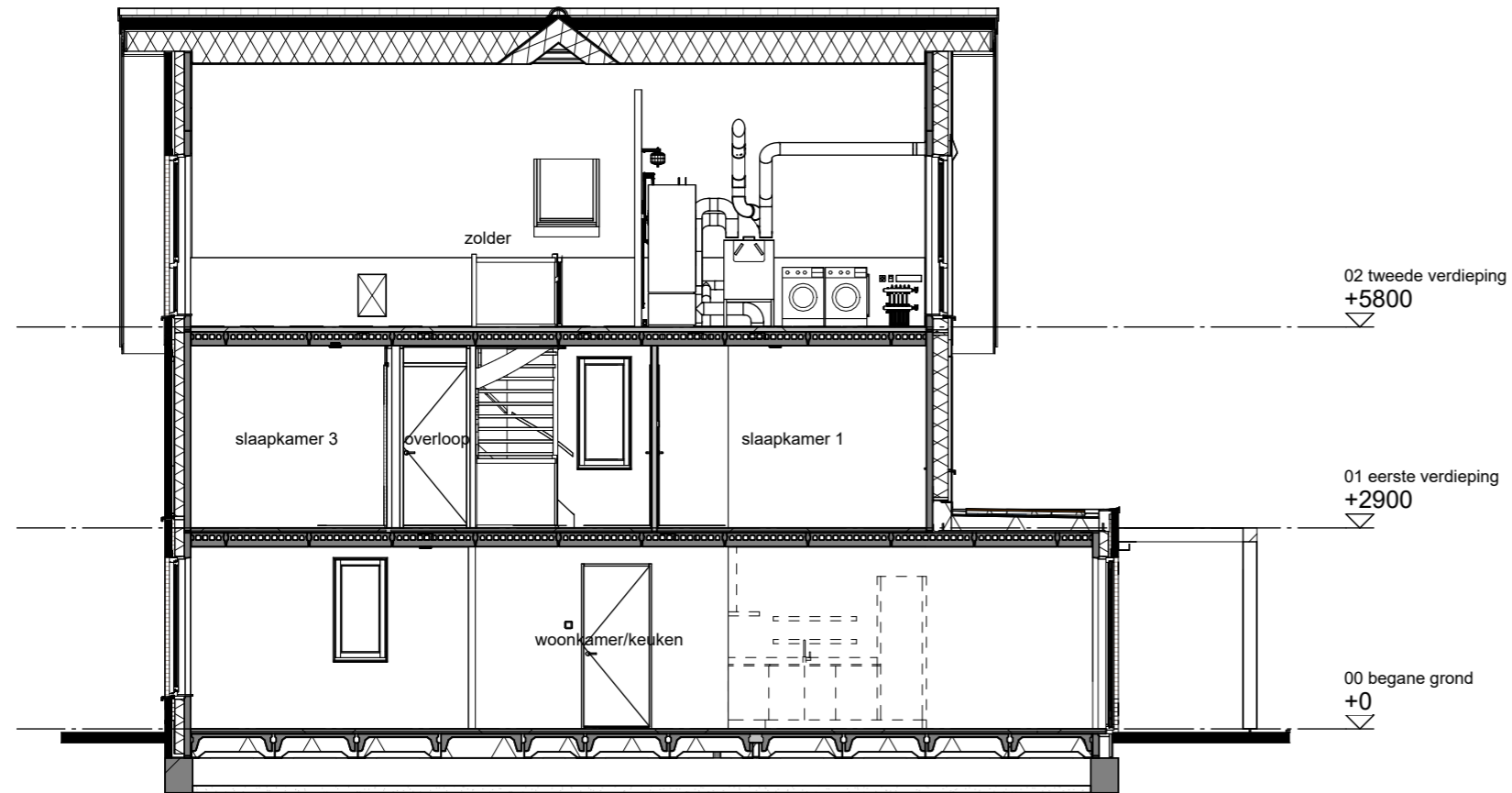

Doorsnede A-A

Type: E60D  
bnr: 10

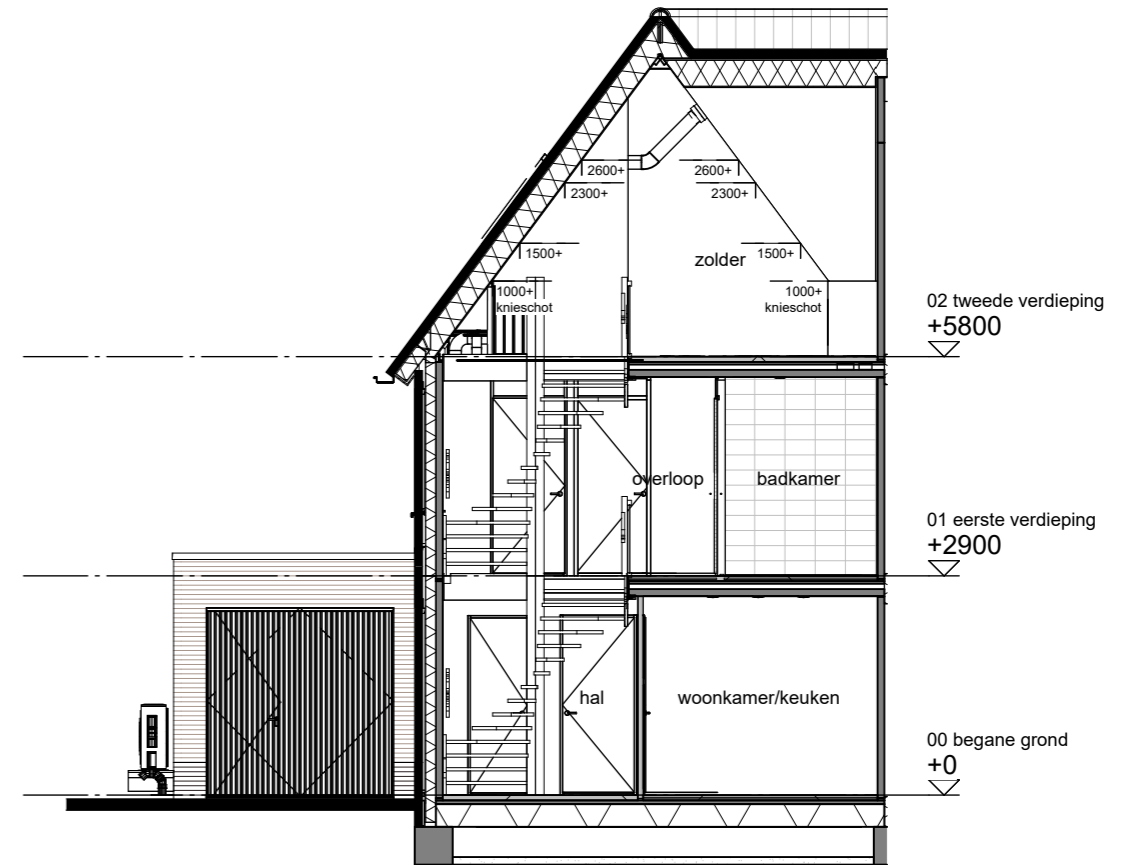

Doorsnede C-C

Type: E60D  
bnr: 10

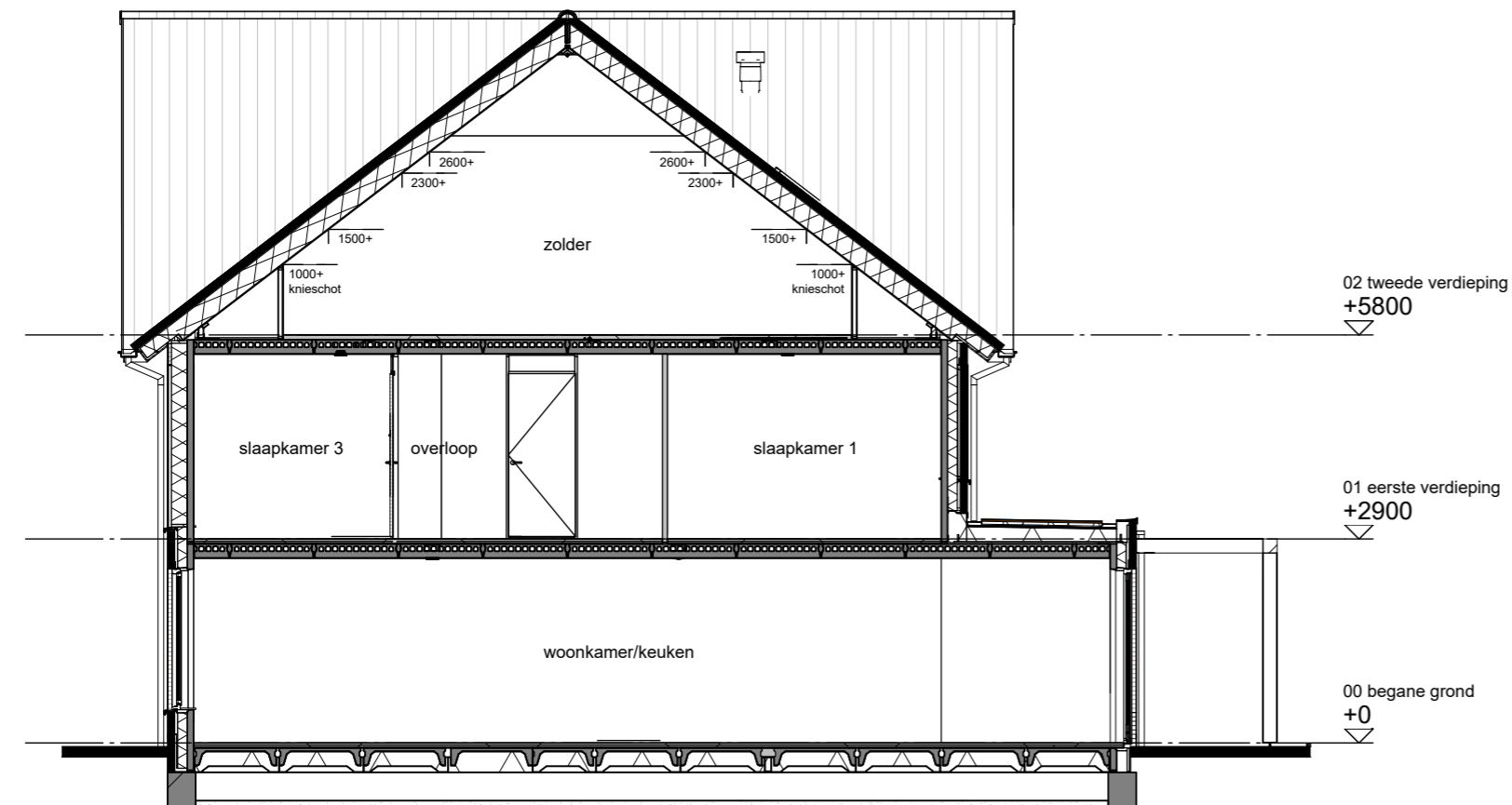

Doorsnede B-B

Type: E60  
bnr: 11



Tekening: Doorsn. blok 7

Woningtype: E60D / E60

Bouwnummer: 10 / 11

Bladnummer: VT-07-00c

Bladformaat: A3

Schaal: 1 : 100

Datum: 21-04-2026

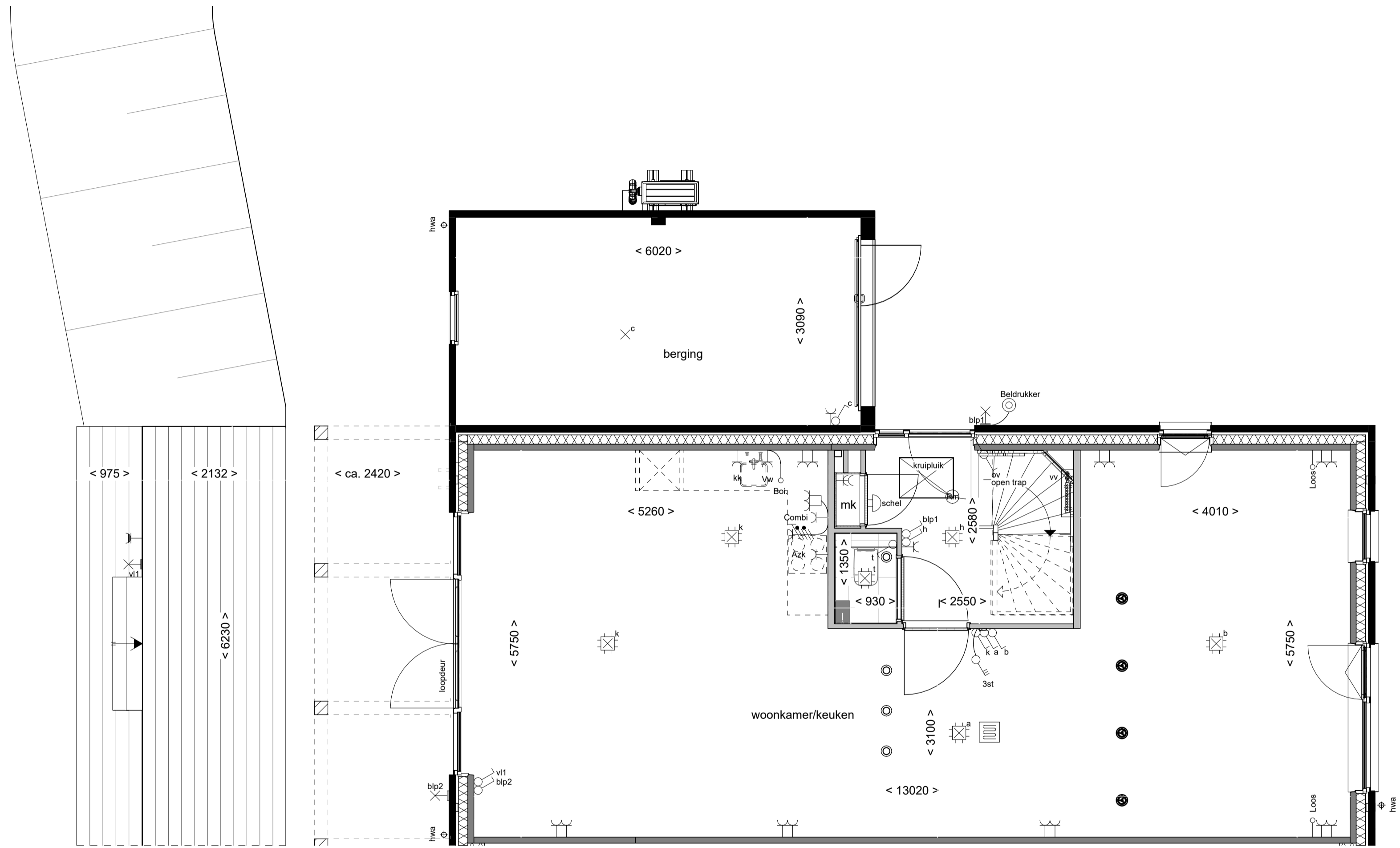

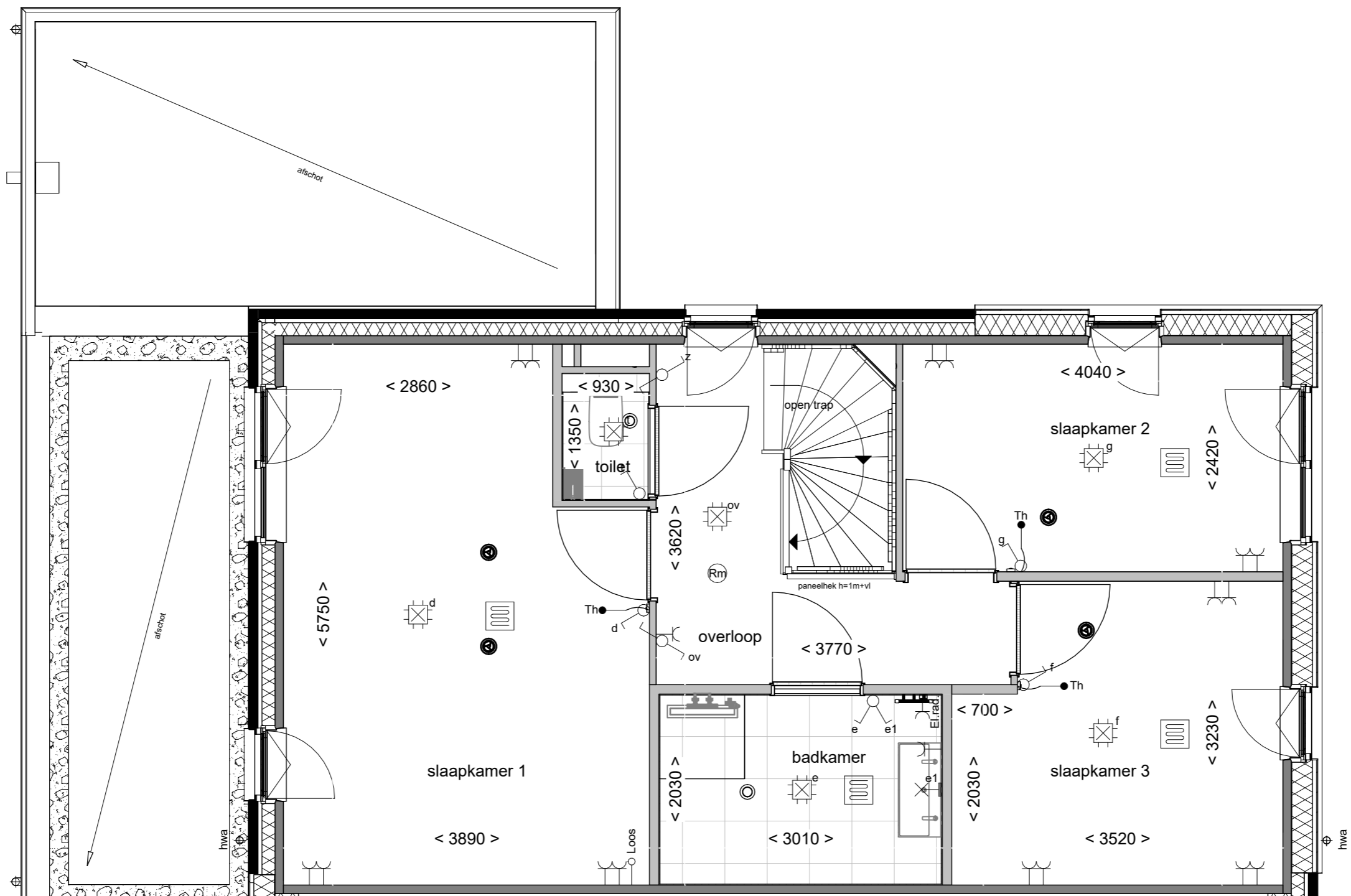

Tekening: **Eerste verdieping**

---

Woningtype: **E60**

---

Bouwnummer: **11**

---

Bladnummer: **VT-07-11b**

---

Bladformaat: **A3**

---

Schaal: **1 : 50**

---

Datum: **21-04-2026**

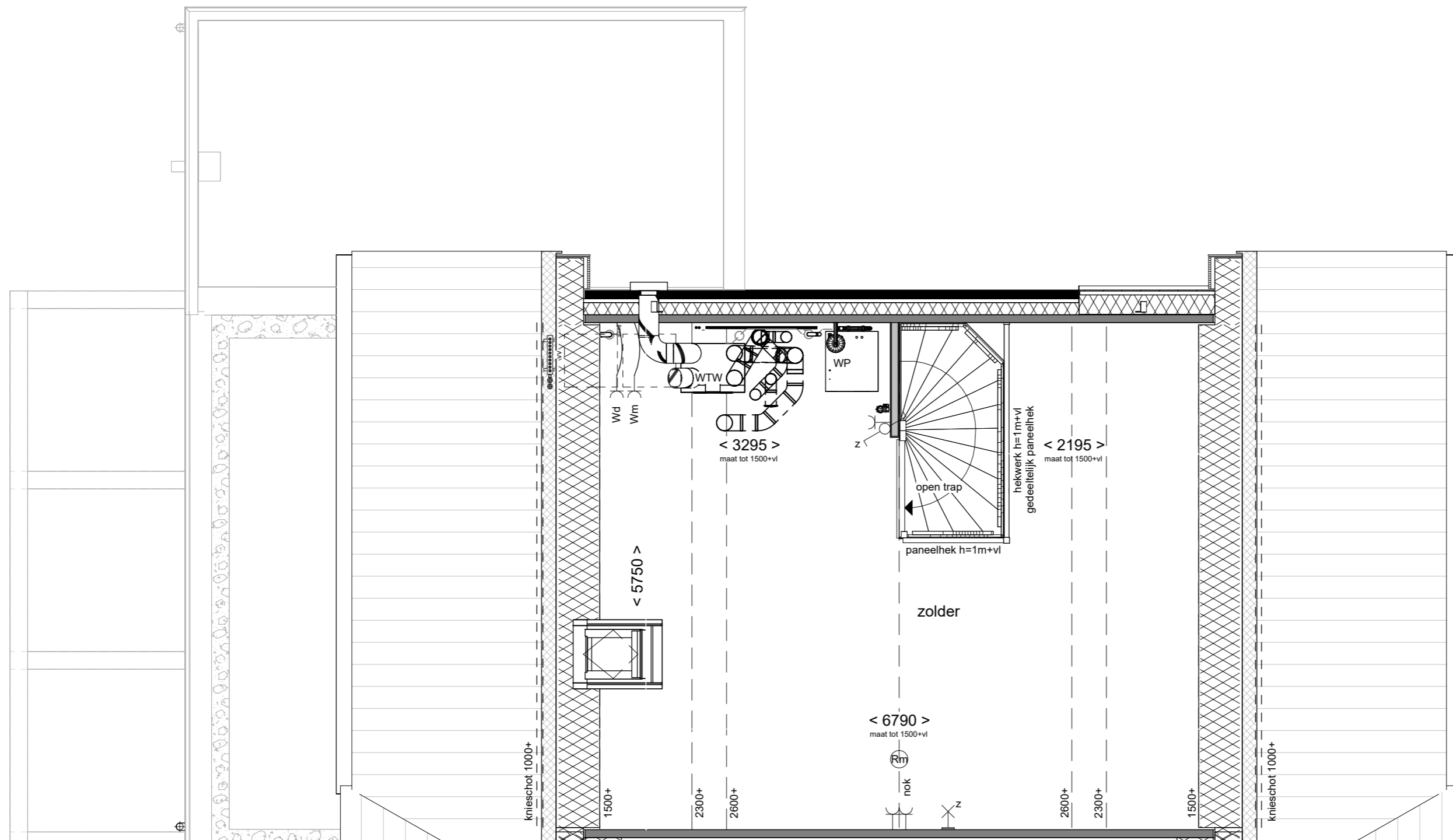

Tekening: Tweede verdieping

Woningtype: E60

Bouwnummer: 11

Bladnummer: VT-07-11c

Bladformaat: A3

Schaal: 1 : 50

Datum: 21-04-2026

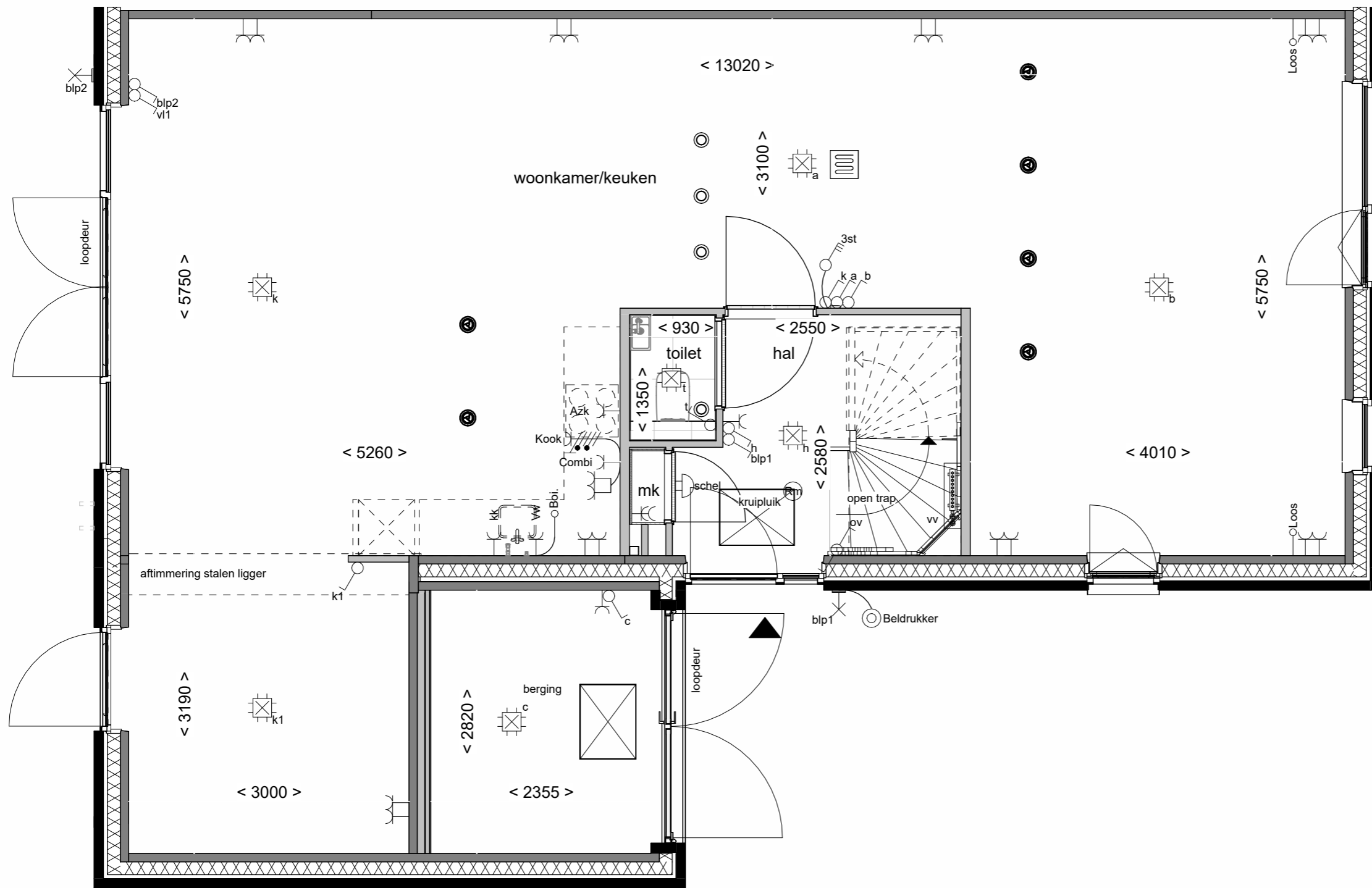

Begane grond

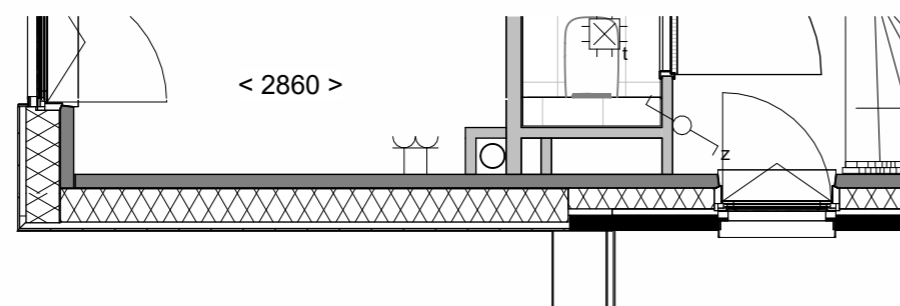

Eerste verdieping (extra schacht)



Achtergevel schaal 1:100



Samenvoegen  
berging bij wnk

Tekening:

Woningtype: E60

Bouwnummer: -

Optienummer: 1.A.E.14

Bladformaat: A3

Schaal: 1:50 / 1:100

Datum: 21-04-2026

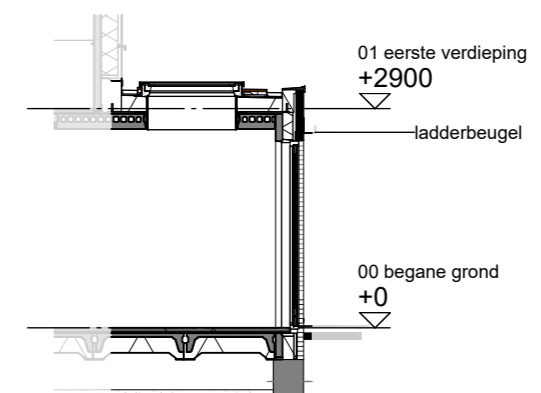
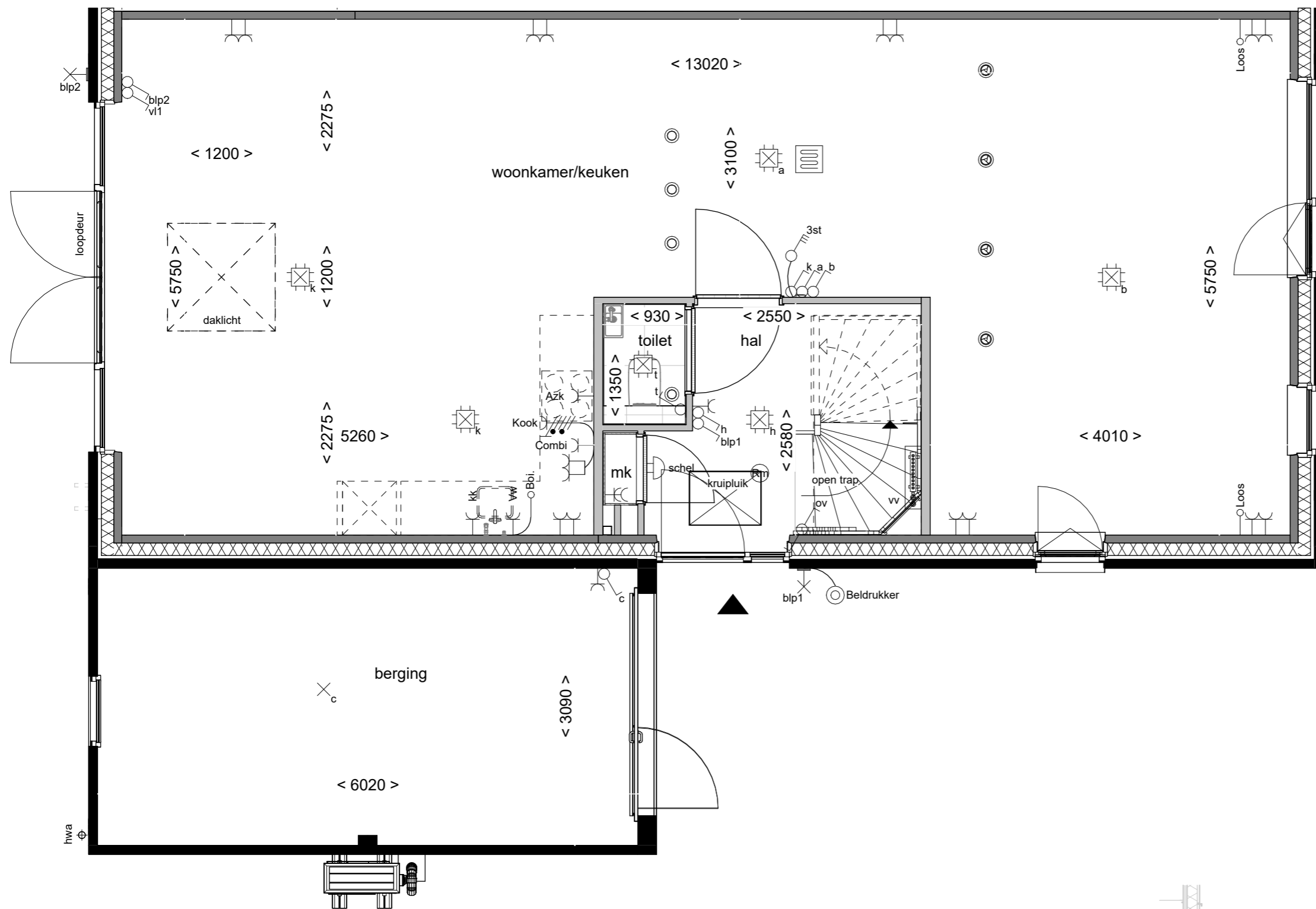

Doorsnede schaal 1:100



**Wonen aan de Gantel**

Lichtkoepel in uitbouw 240cm

Tekening: \_\_\_\_\_

Woningtype: E60

Bouwnummer: -

Optienummer: 1.B.X.10

Bladformaat: A3

Schaal: 1:50 / 1:100

Datum: 21-04-2026

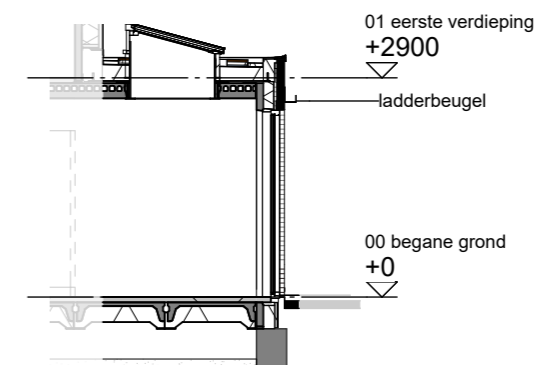
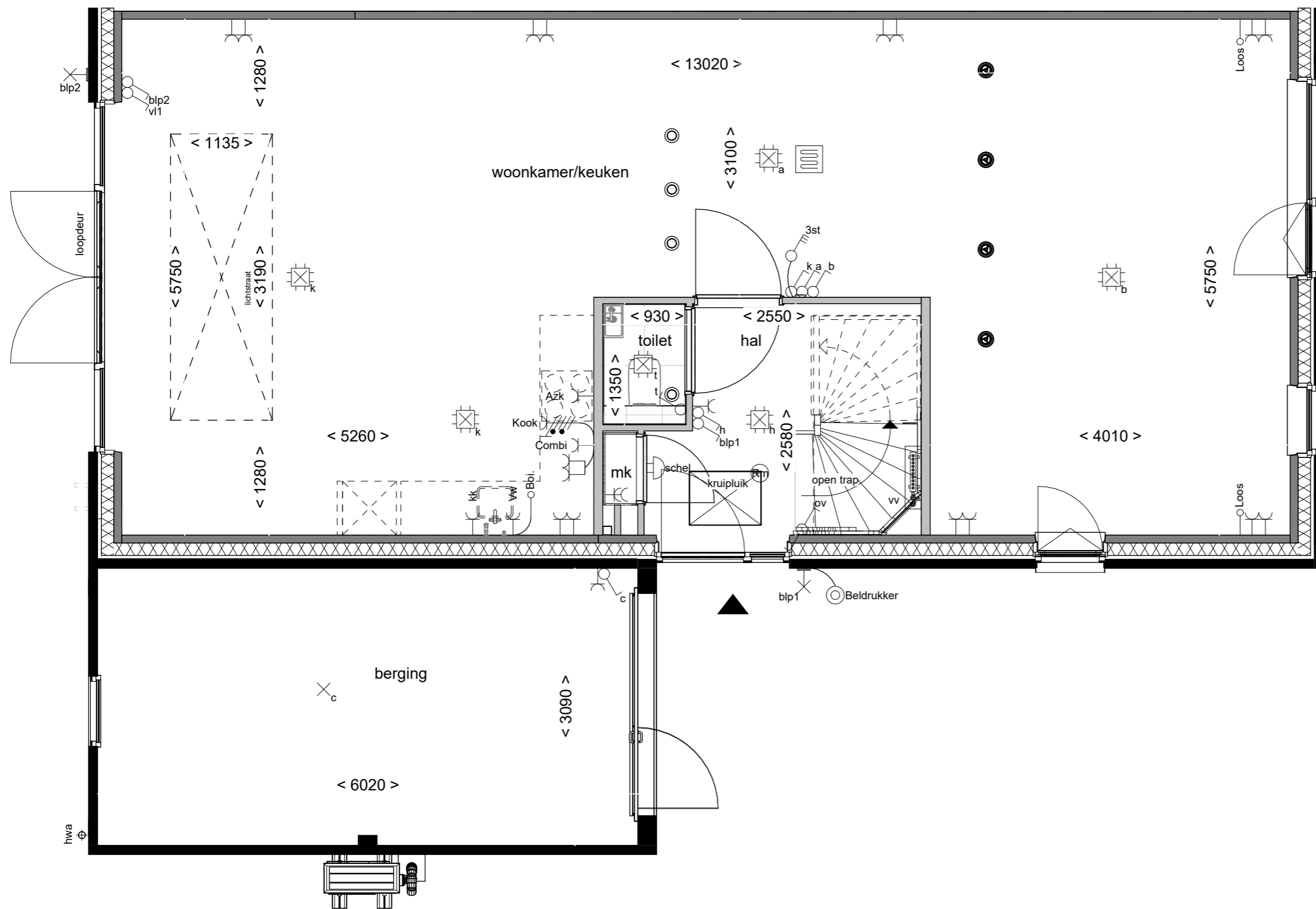

Doorsnede schaal 1:100



Lichtstraat in uitbouw  
240cm

Tekening: 240cm

Woningtype: E60

Bouwnummer: -

Optienummer: 1.B.X.14

Bladformaat: A3

Schaal: 1:50 / 1:100

Datum: 21-04-2026

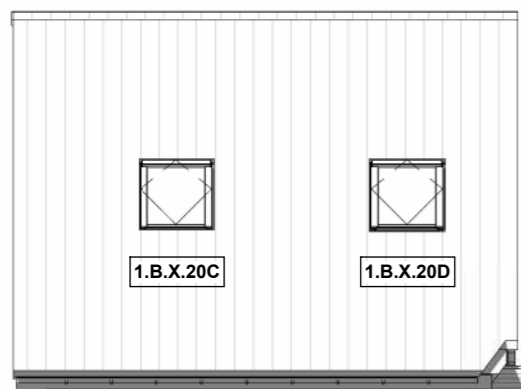
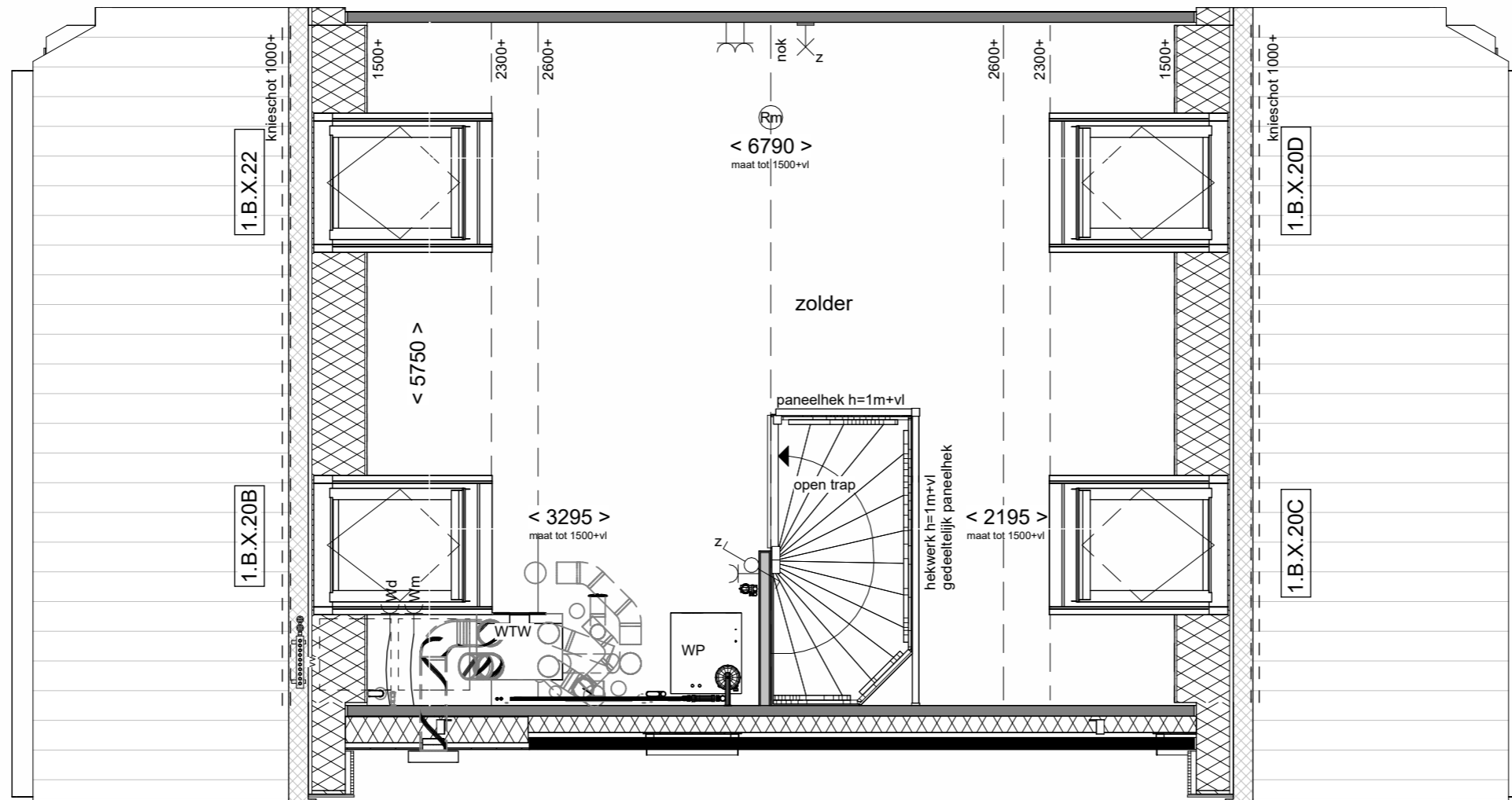

Voorgevel schaal 1:100

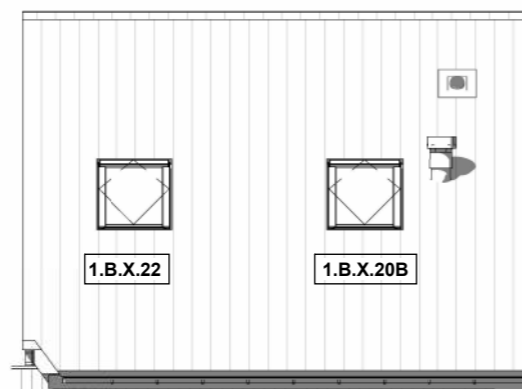

Achtergevel schaal 1:100

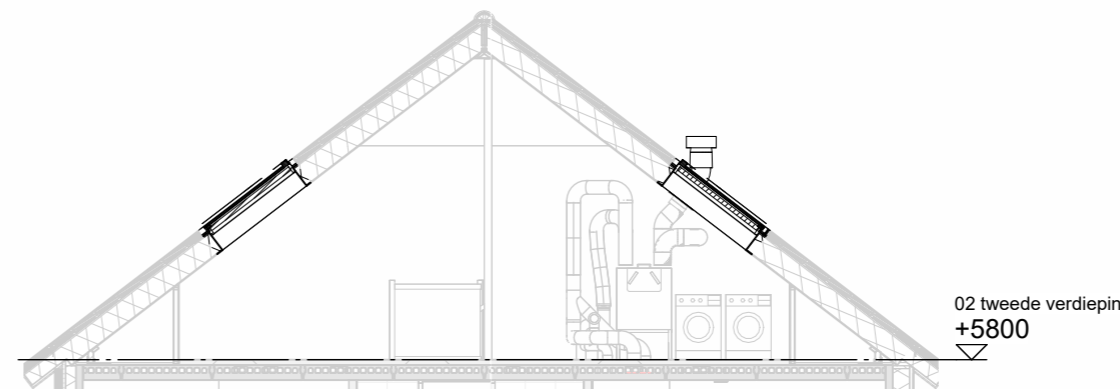

Doorsnede schaal 1:100



Dakramen voor- en achtergevel

Tekening:

Woningtype: E60

Bouwnummer: -

Optienummer: 1.B.X.20 / 1.B.X.22

Bladformaat: A3

Schaal: 1:50 / 1:100

Datum: 21-04-2026

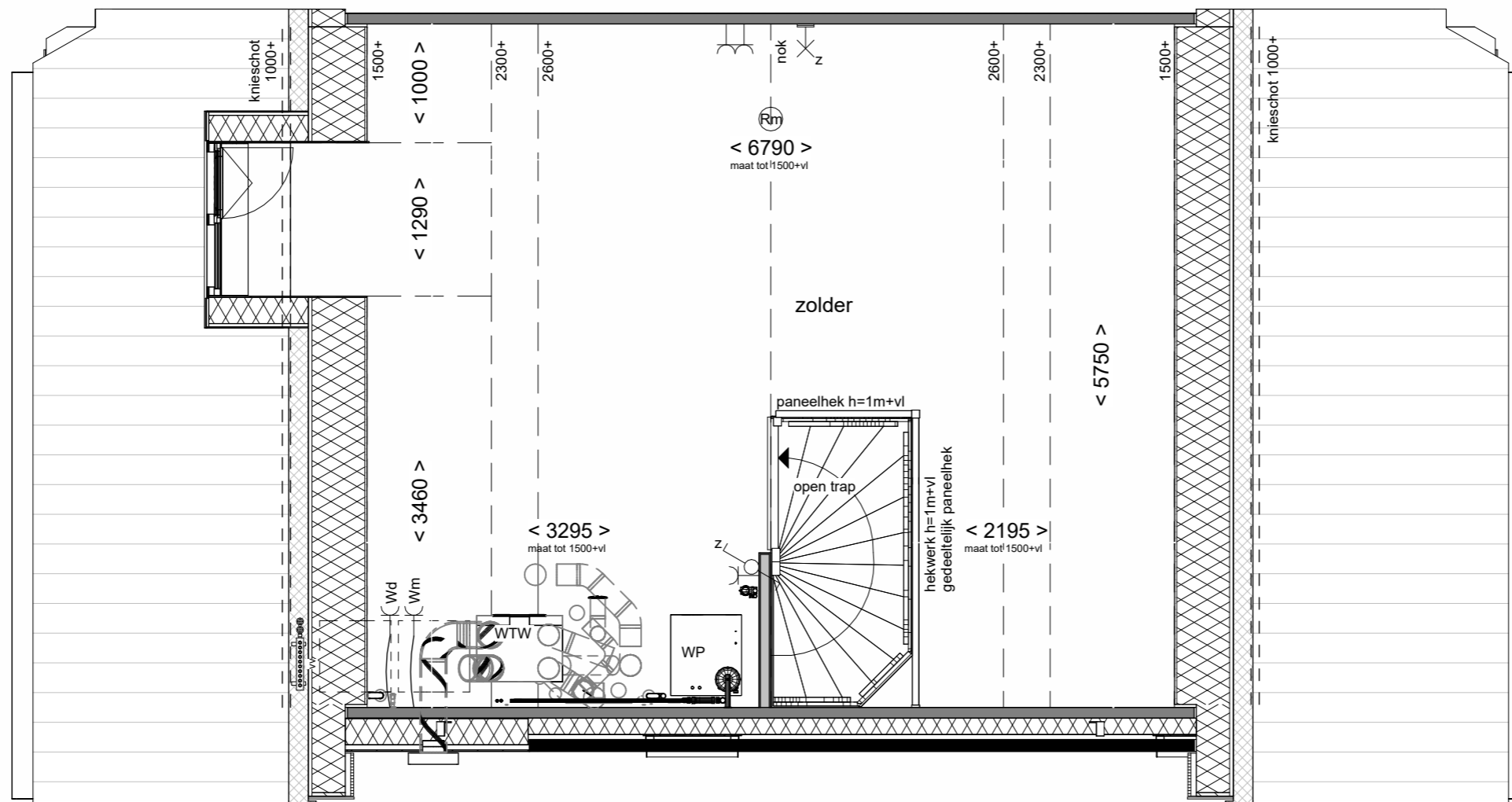

Achtergevel schaal 1:100

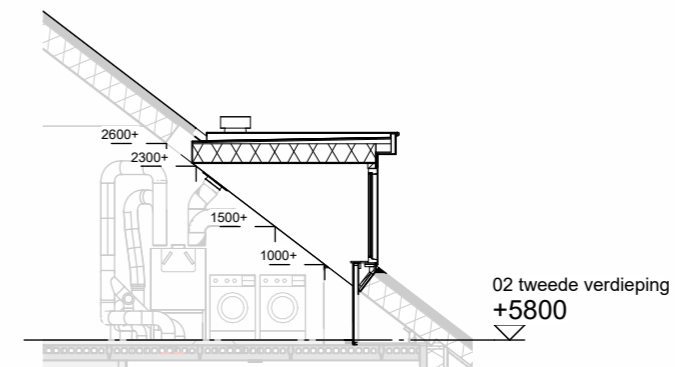

Doorsnede schaal 1:100



Tekening: Dakkapel achtergevel 130cm

Woningtype: E60

Bouwnummer: -

Optienummer: 1.B.X.32

Bladformaat: A3

Schaal: 1:50 / 1:100

Datum: 21-04-2026

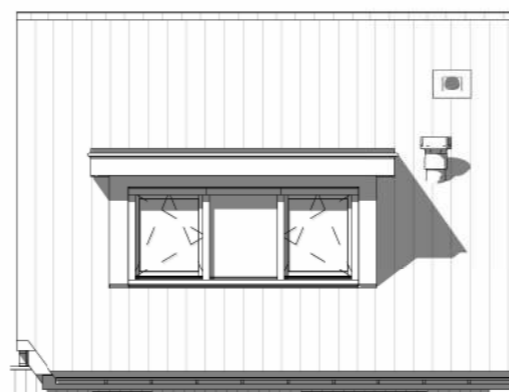
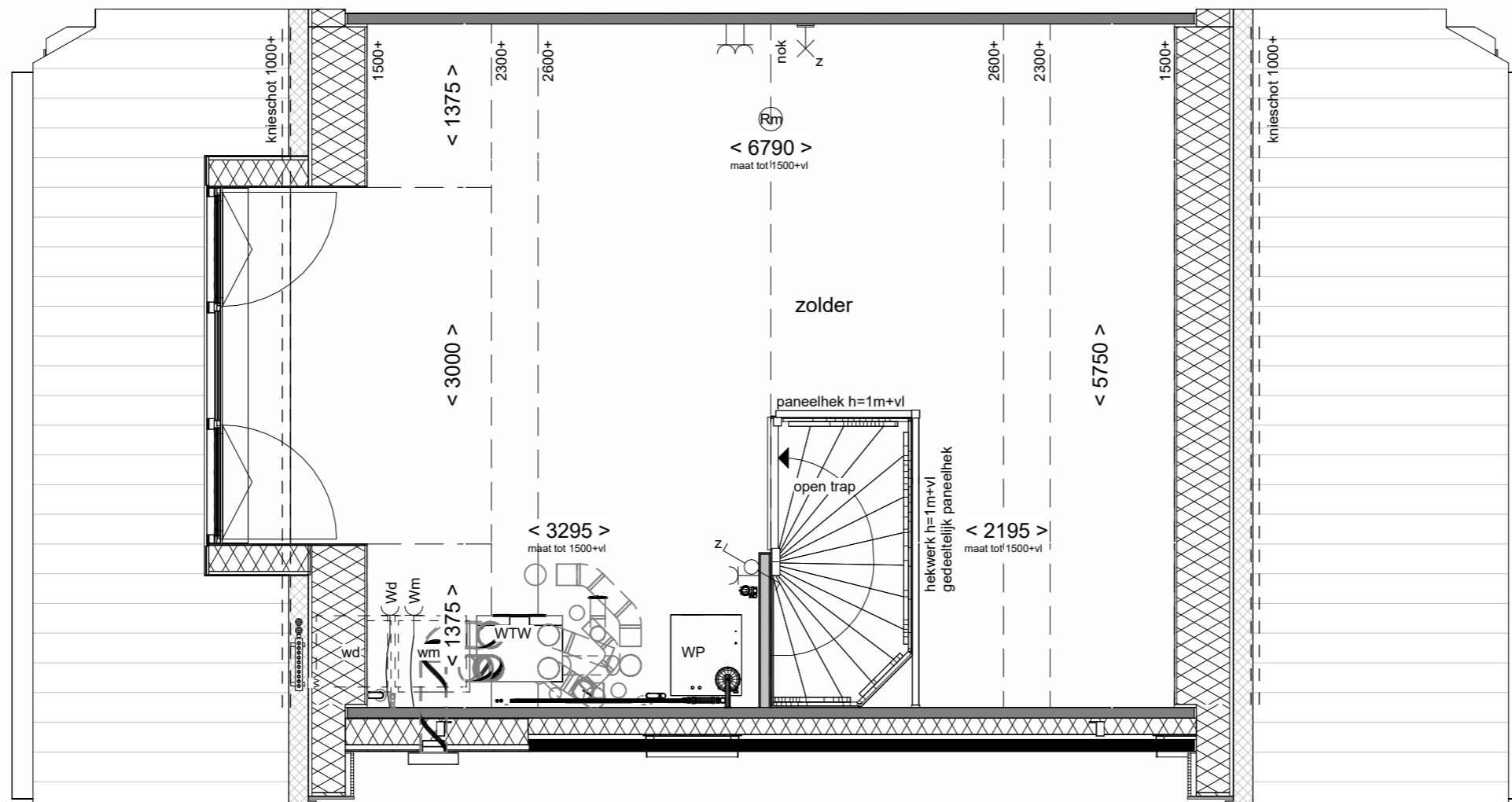

Achtergevel schaal 1:100

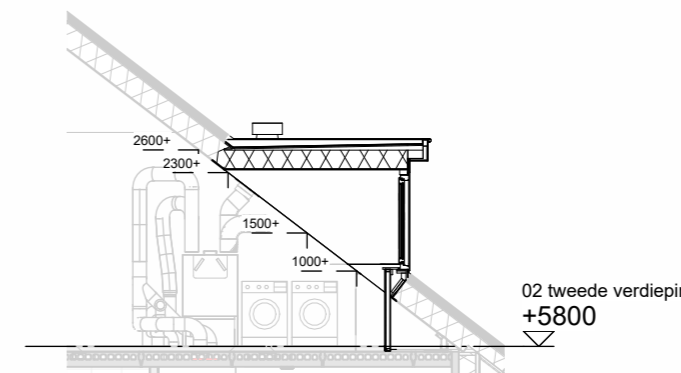

Doorsnede schaal 1:100



Dakkapel  
achtergevel 300cm

Tekening: Dakkapel achtergevel 300cm

Woningtype: E60

Bouwnummer: -

Optienummer: 1.B.X.36

Bladformaat: A3

Schaal: 1:50 / 1:100

Datum: 21-04-2026

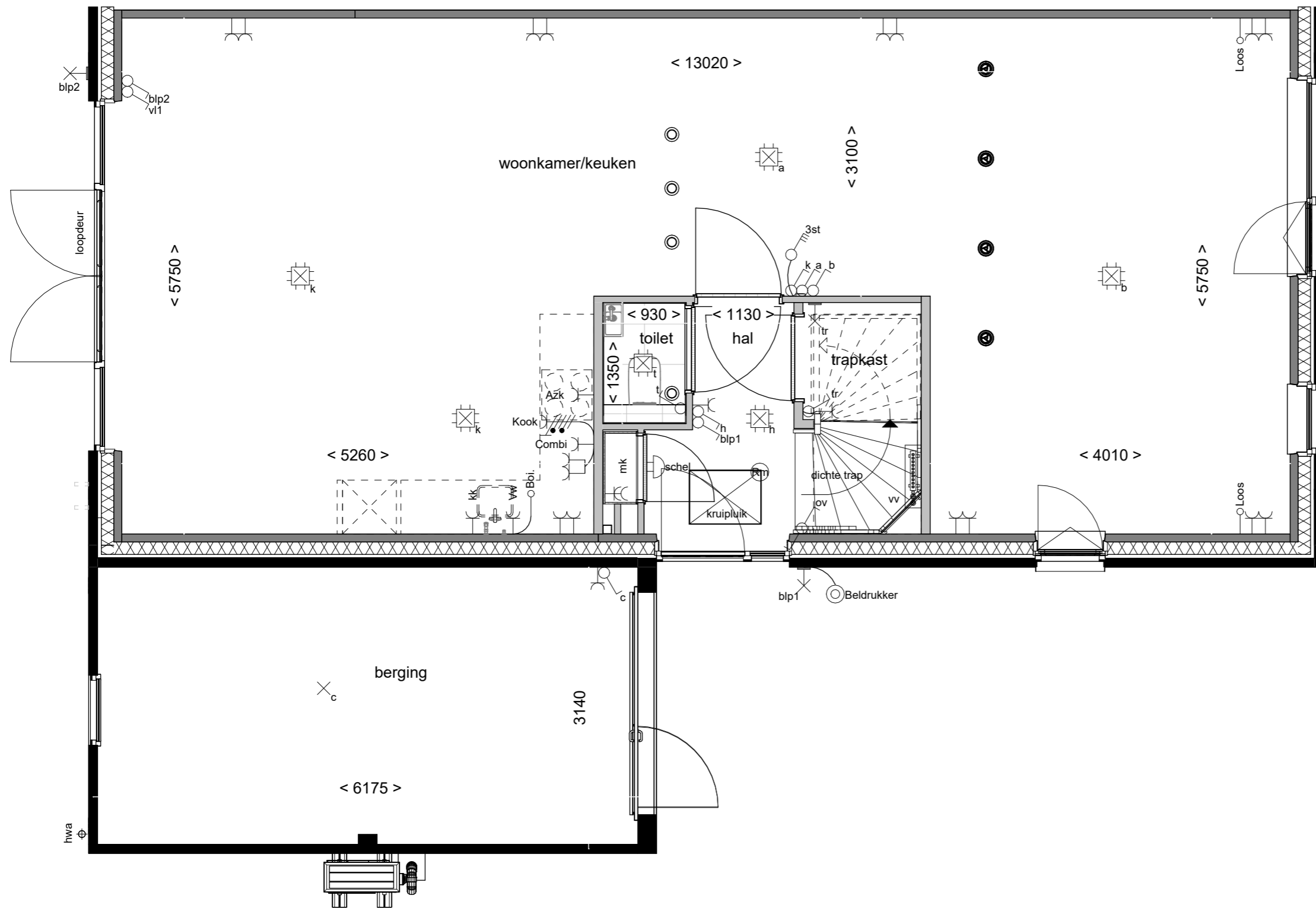

Tekening: Trapkast

Woningtype: E60

Bouwnummer: -

Optienummer: 1.C.E.10

Bladformaat: A3

Schaal: 1:50

Datum: 21-04-2026

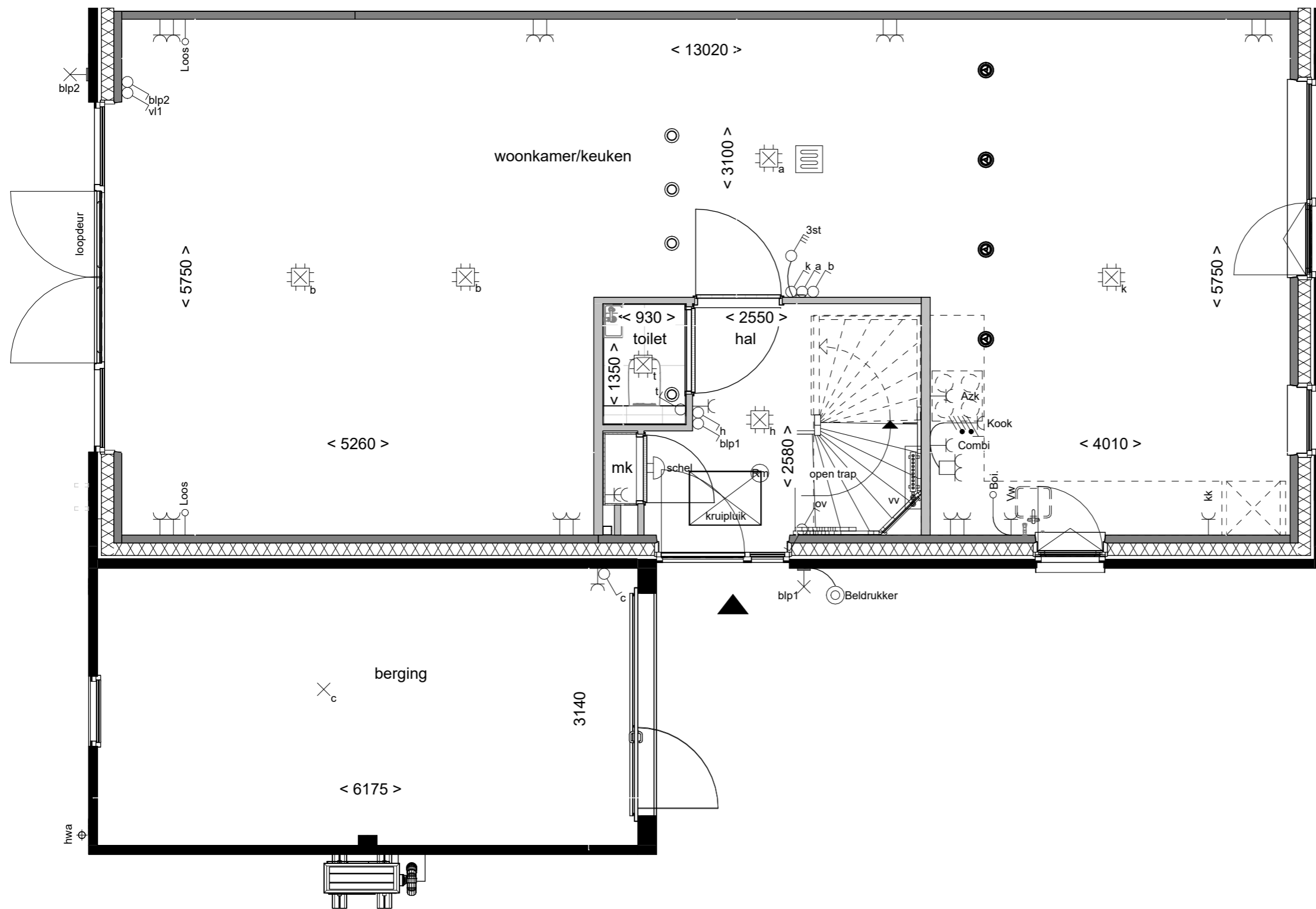

Tekening: **Tuingericht wonen**  
 Woningtype: **E60**  
 Bouwnummer: **-**  
 Optienummer: **1.C.E.12**  
 Bladformaat: **A3**  
 Schaal: **1:50**  
 Datum: **21-04-2026**

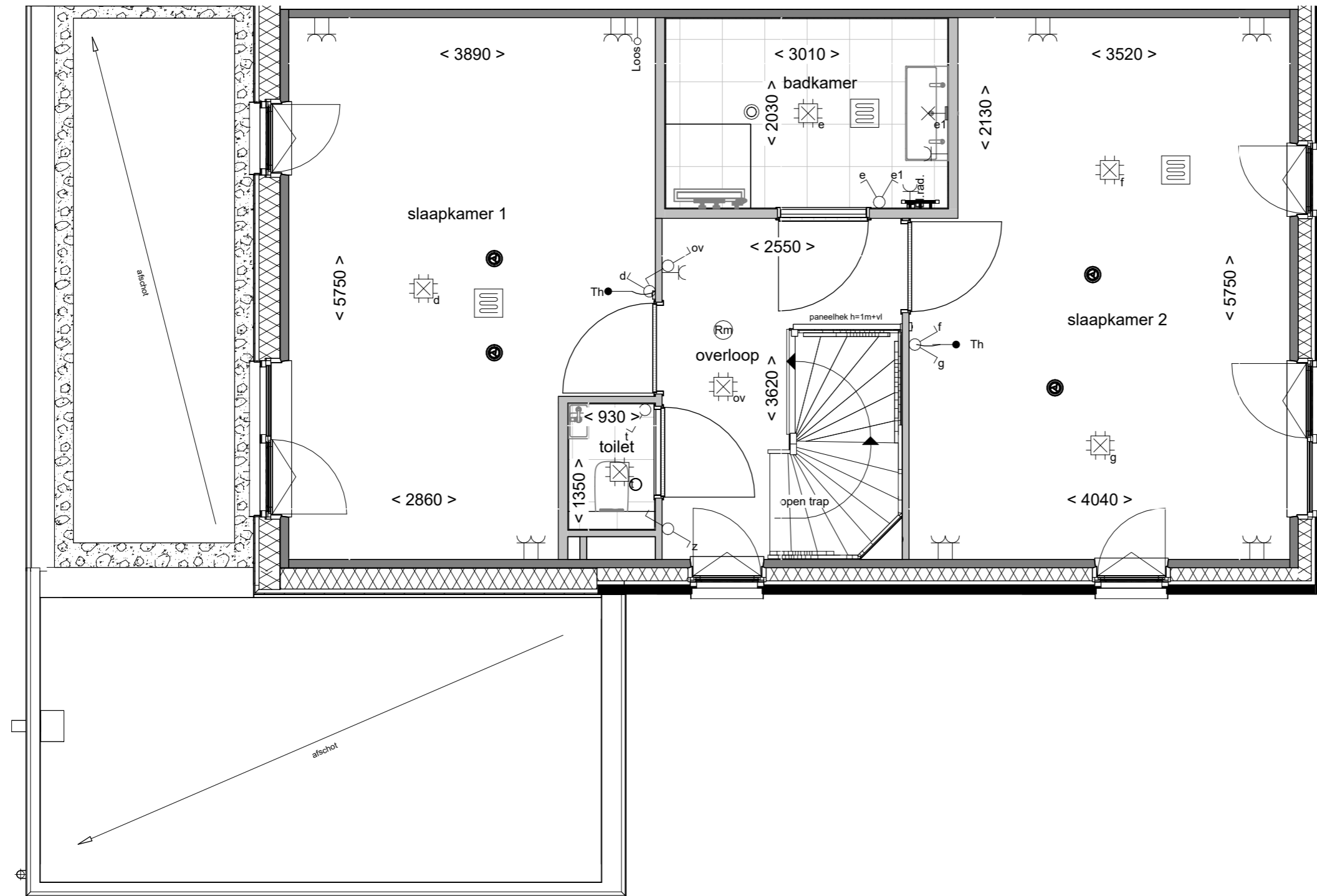

Samenvoegen  
slaapkamers voor

Tekening: \_\_\_\_\_

Woningtype: E60

Bouwnummer: -

Optienummer: 1.C.E.30

Bladformaat: A3

Schaal: 1:50

Datum: 21-04-2026

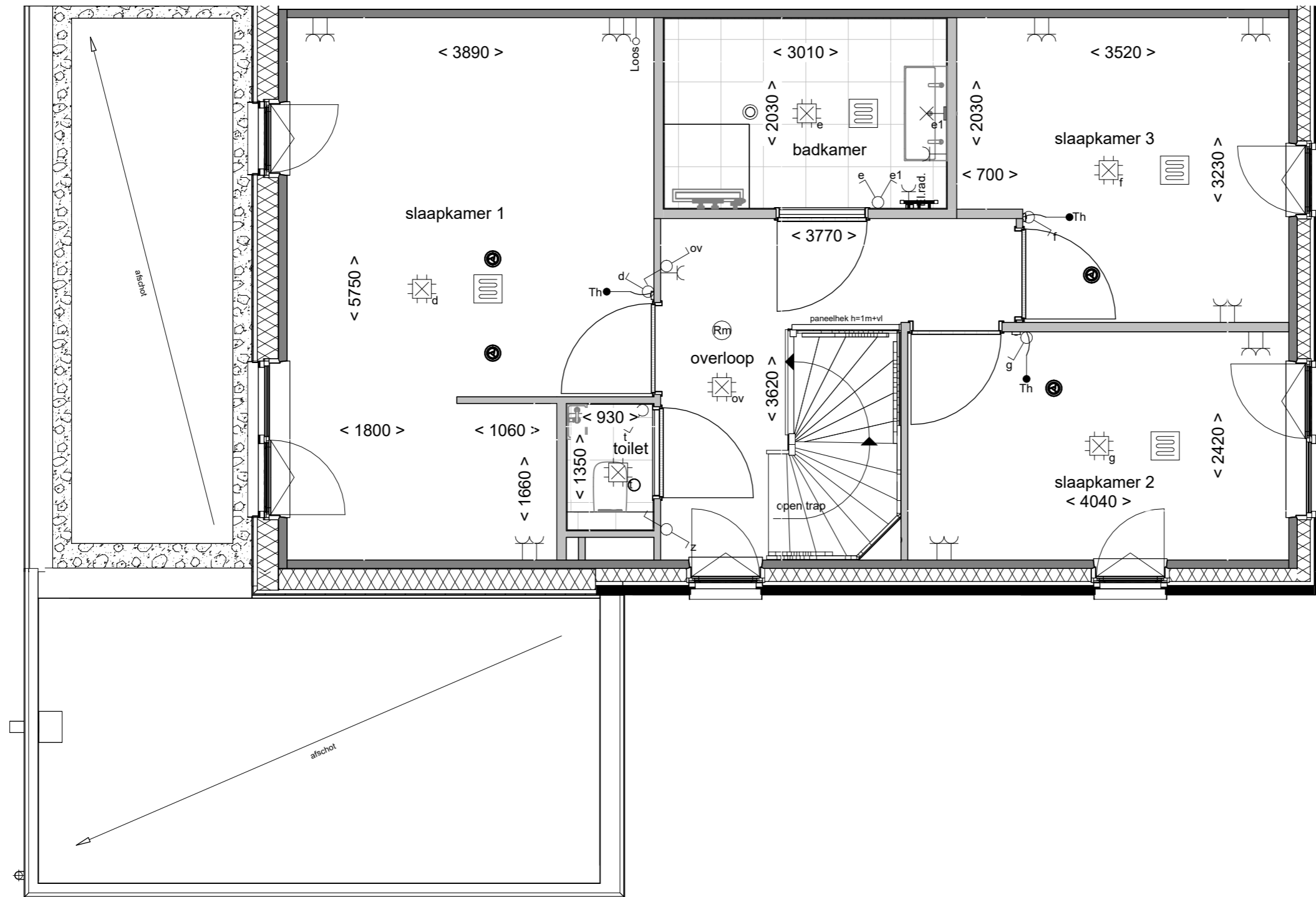

Inloopkast in  
slaapkamer achter

Tekening:

Woningtype: E60

Bouwnummer: -

Optienummer: 1.C.E.32

Bladformaat: A3

Schaal: 1:50

Datum: 21-04-2026

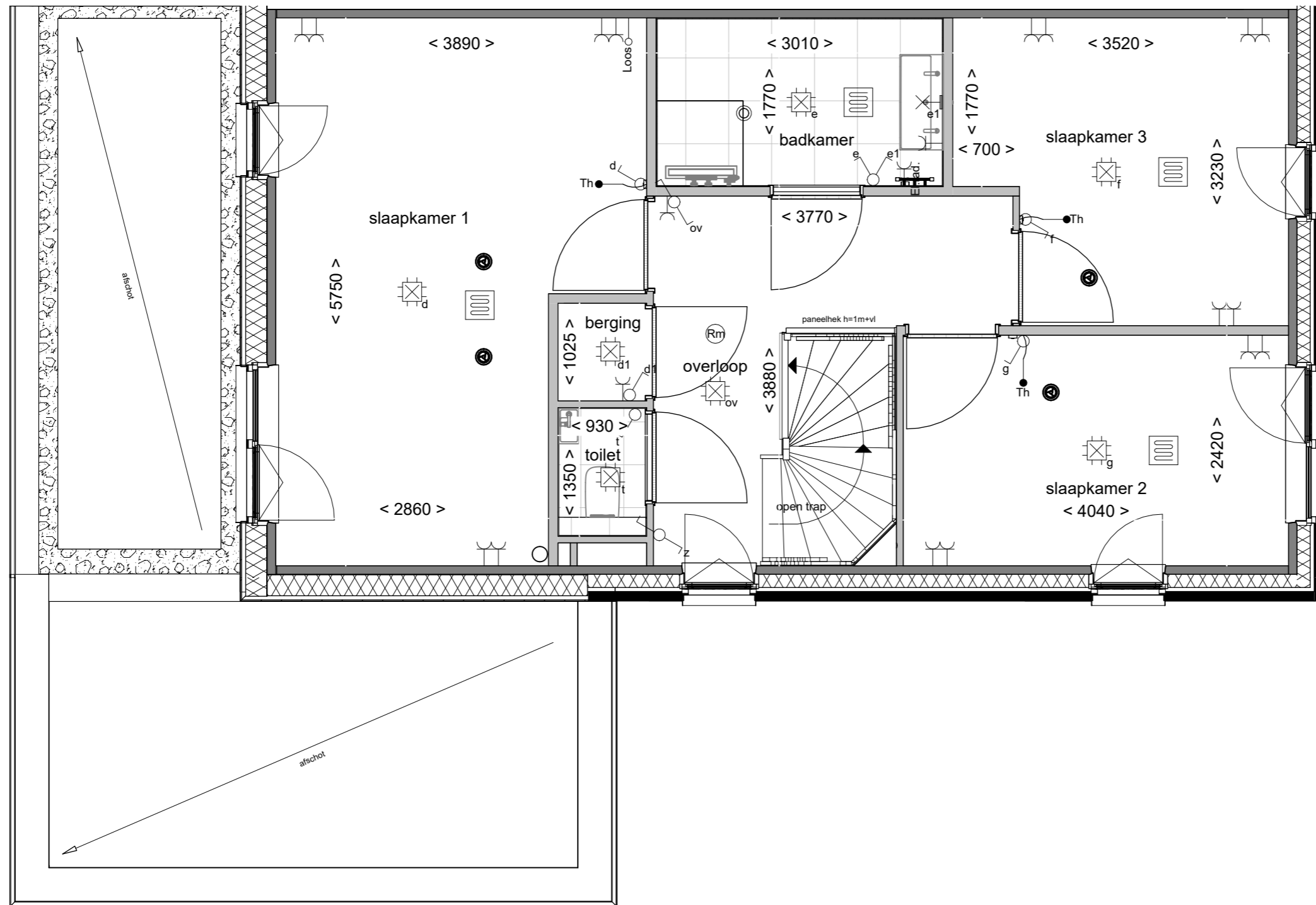

Vaste kast en compacte badk.

Tekening: \_\_\_\_\_

Woningtype: E60

Bouwnummer: -

Optienummer: 1.C.E.34

Bladformaat: A3

Schaal: 1:50

Datum: 21-04-2026

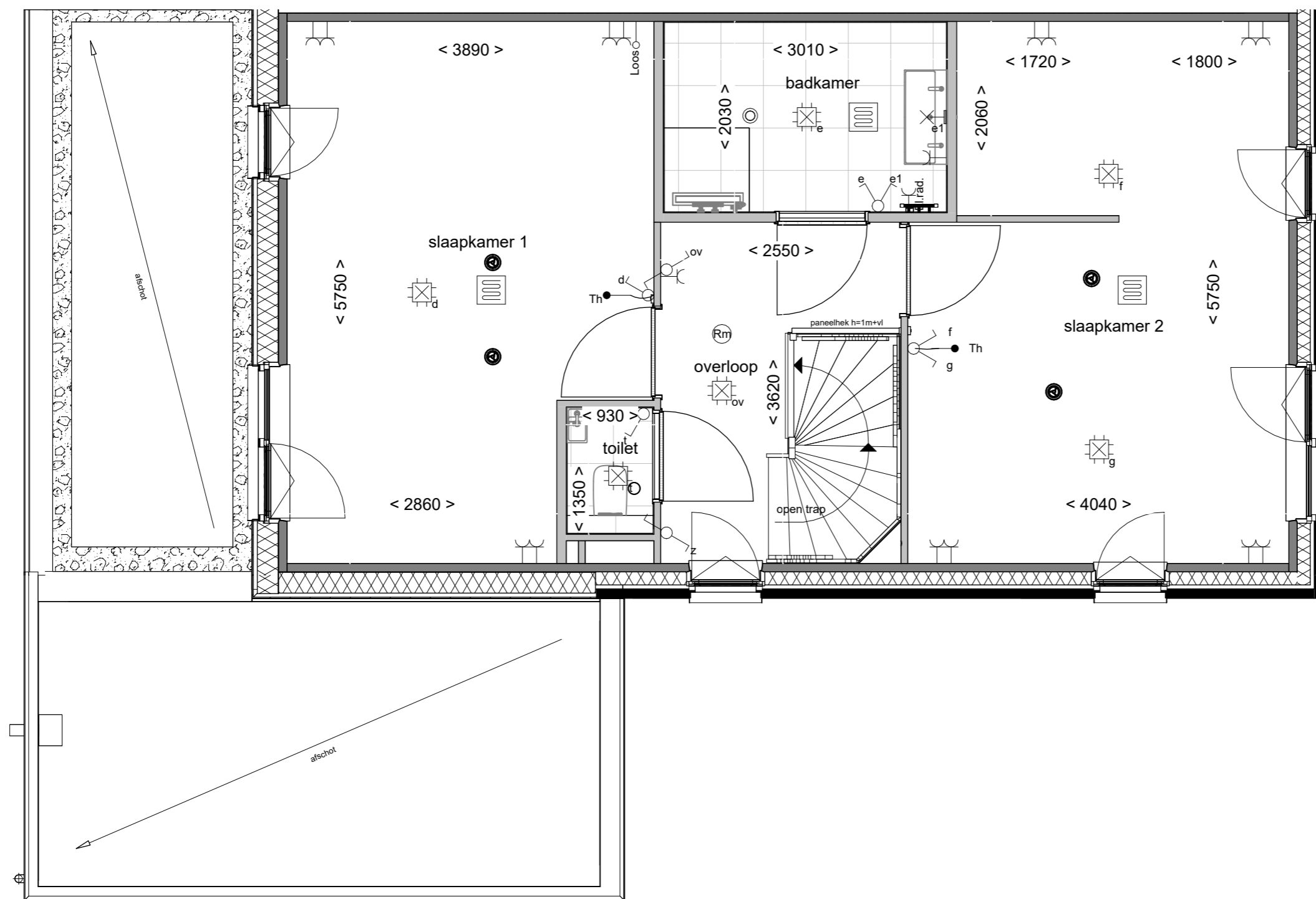

Samenvoegen slpk  
voor met inloopkast

Tekening:

Woningtype: E60

Bouwnummer: -

Optienummer: 1.C.E.36

Bladformaat: A3

Schaal: 1:50

Datum: 21-04-2026

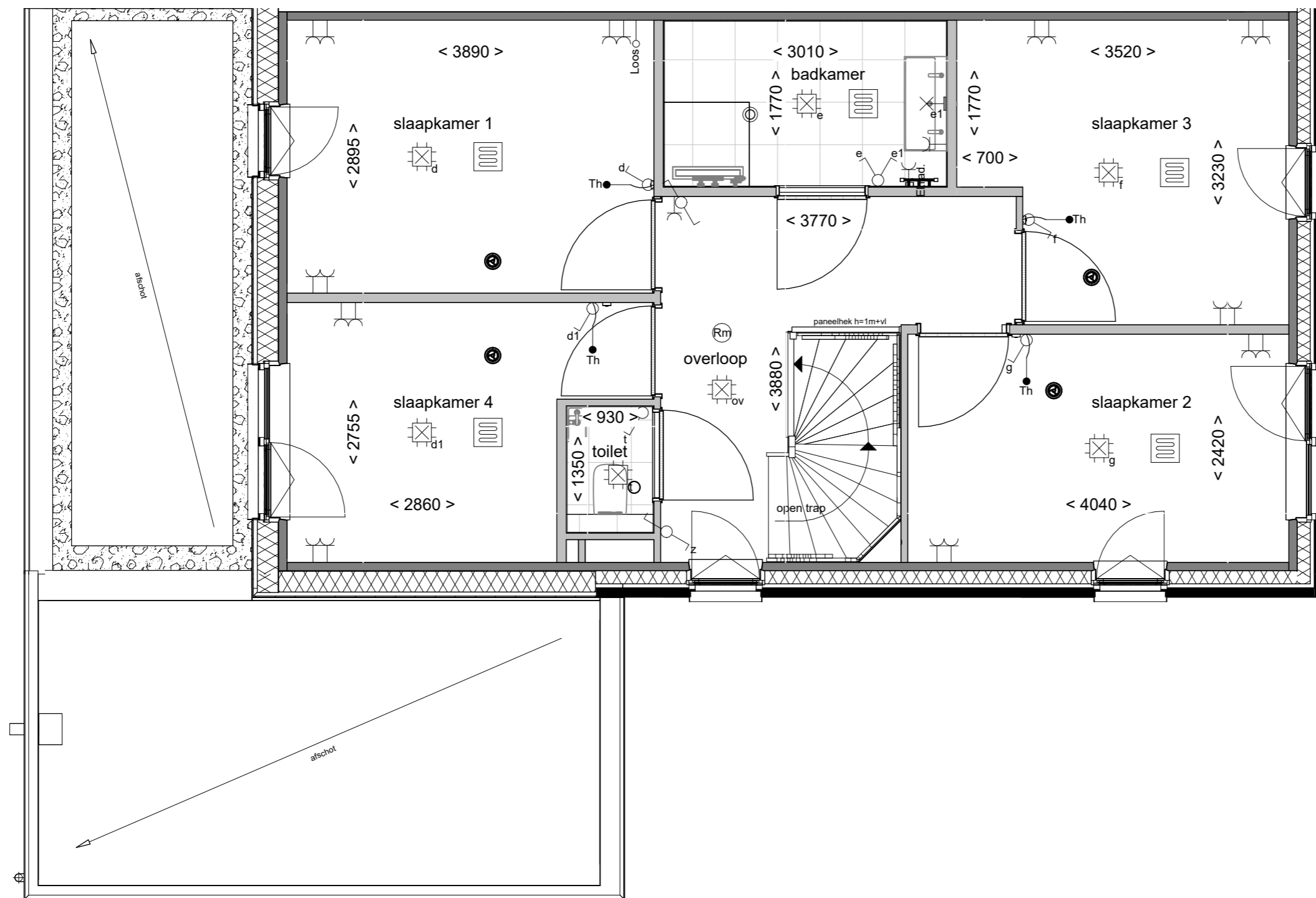

**Wonen aan de Gantel**  
 Compacte badk. met 4 slaapkamers

Tekening: **4 slaapkamers**

Woningtype: **E60**

Bouwnummer: **-**

Optienummer: **1.C.E.38**

Bladformaat: **A3**

Schaal: **1:50**

Datum: **21-04-2026**

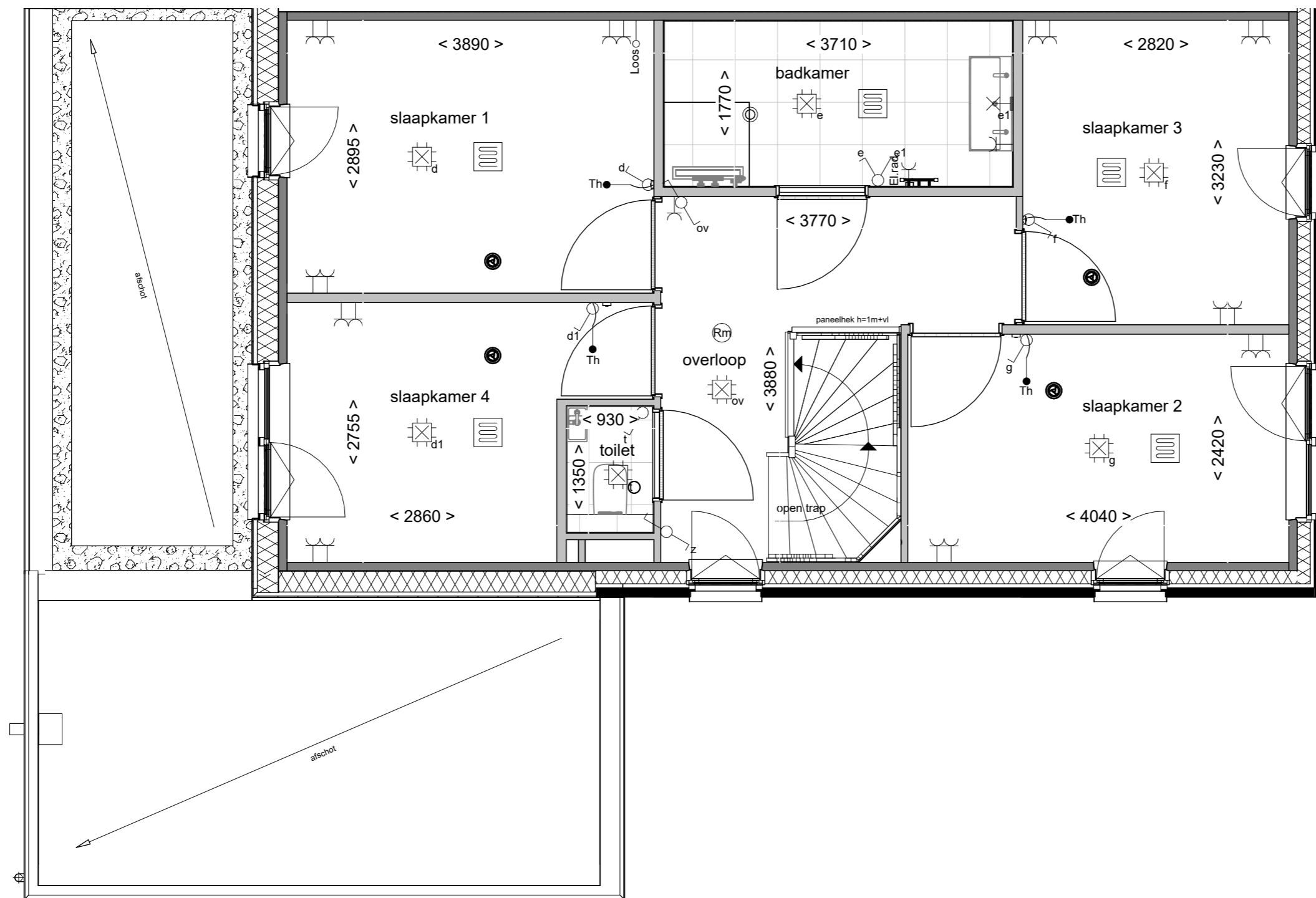

Verl. compacte badk.  
met 4 slpk

Tekening: \_\_\_\_\_

Woningtype: E60 \_\_\_\_\_

Bouwnummer: - \_\_\_\_\_

Optienummer: 1.C.E.40 \_\_\_\_\_

Bladformaat: A3 \_\_\_\_\_

Schaal: 1:50 \_\_\_\_\_

Datum: 21-04-2026 \_\_\_\_\_

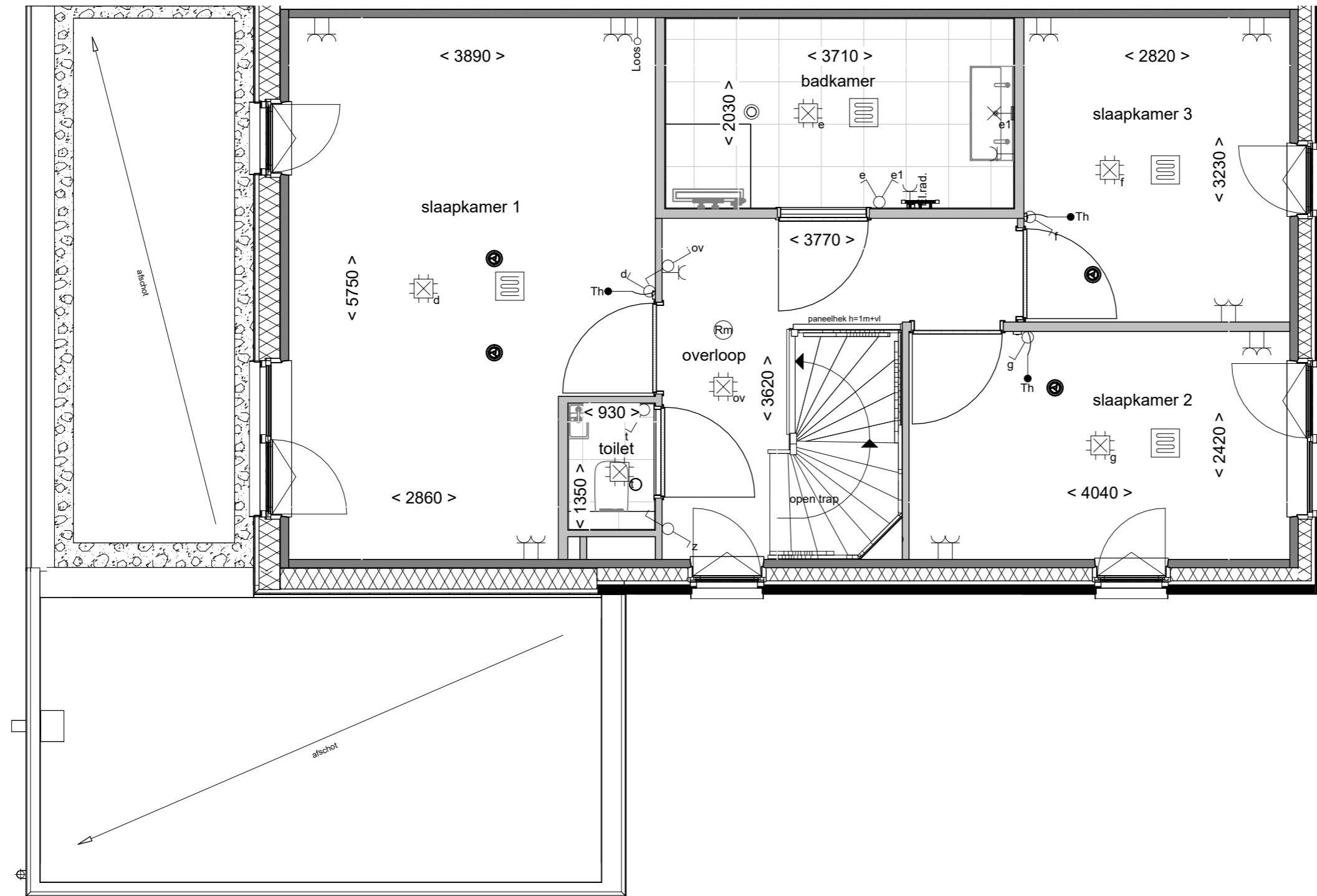

Tekening: **Badkamer vergroten**

Woningtype: **E60**

Bouwnummer: **-**

Optienummer: **1.C.E.42**

Bladformaat: **A3**

Schaal: **1:50**

Datum: **21-04-2026**

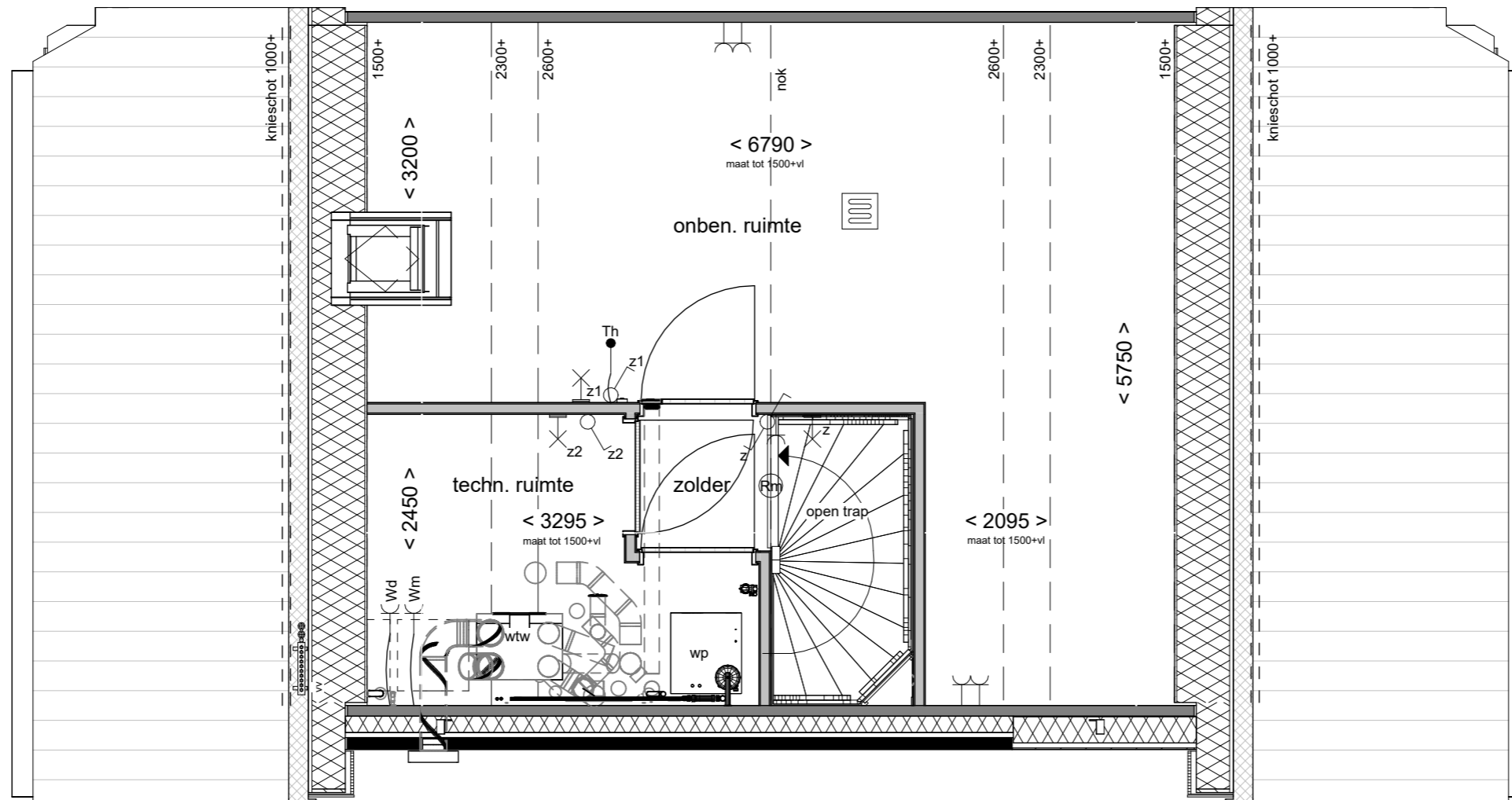

Tekening: Indeling met 1 onben. ruimte

Woningtype: E60

Bouwnummer: -

Optienummer: 1.C.E.74

Bladformaat: A3

Schaal: 1:50

Datum: 21-04-2026

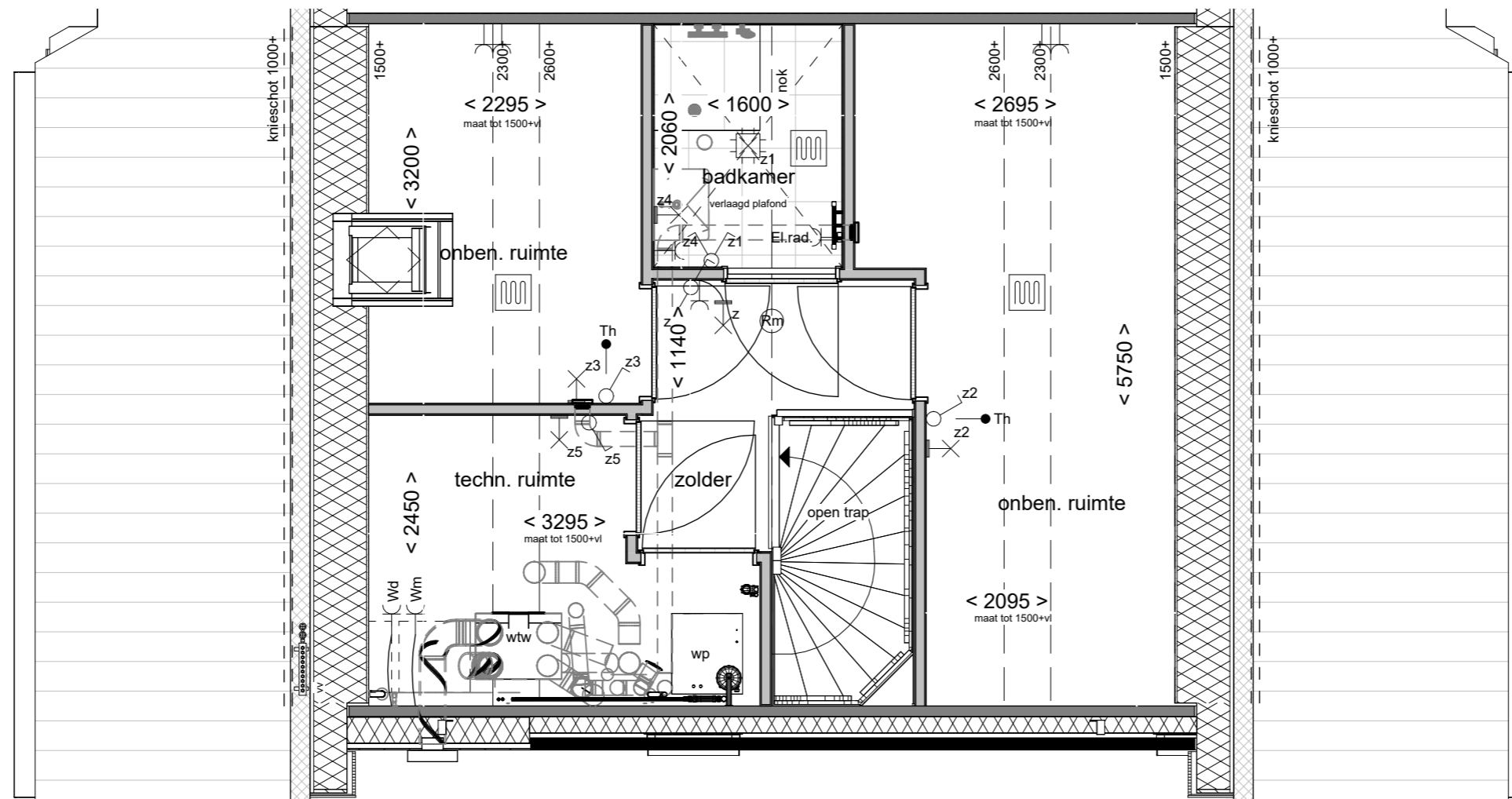

**Indeling 2 ruimten en badkamer**

Tekening: \_\_\_\_\_

Woningtype: E60 \_\_\_\_\_

Bouwnummer: - \_\_\_\_\_

Optienummer: 1.C.E.78 \_\_\_\_\_

Bladformaat: A3 \_\_\_\_\_

Schaal: 1:50 \_\_\_\_\_

Datum: 21-04-2026 \_\_\_\_\_

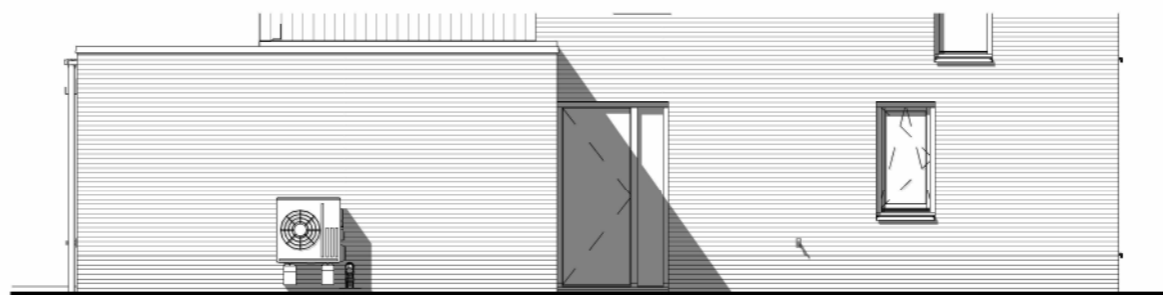
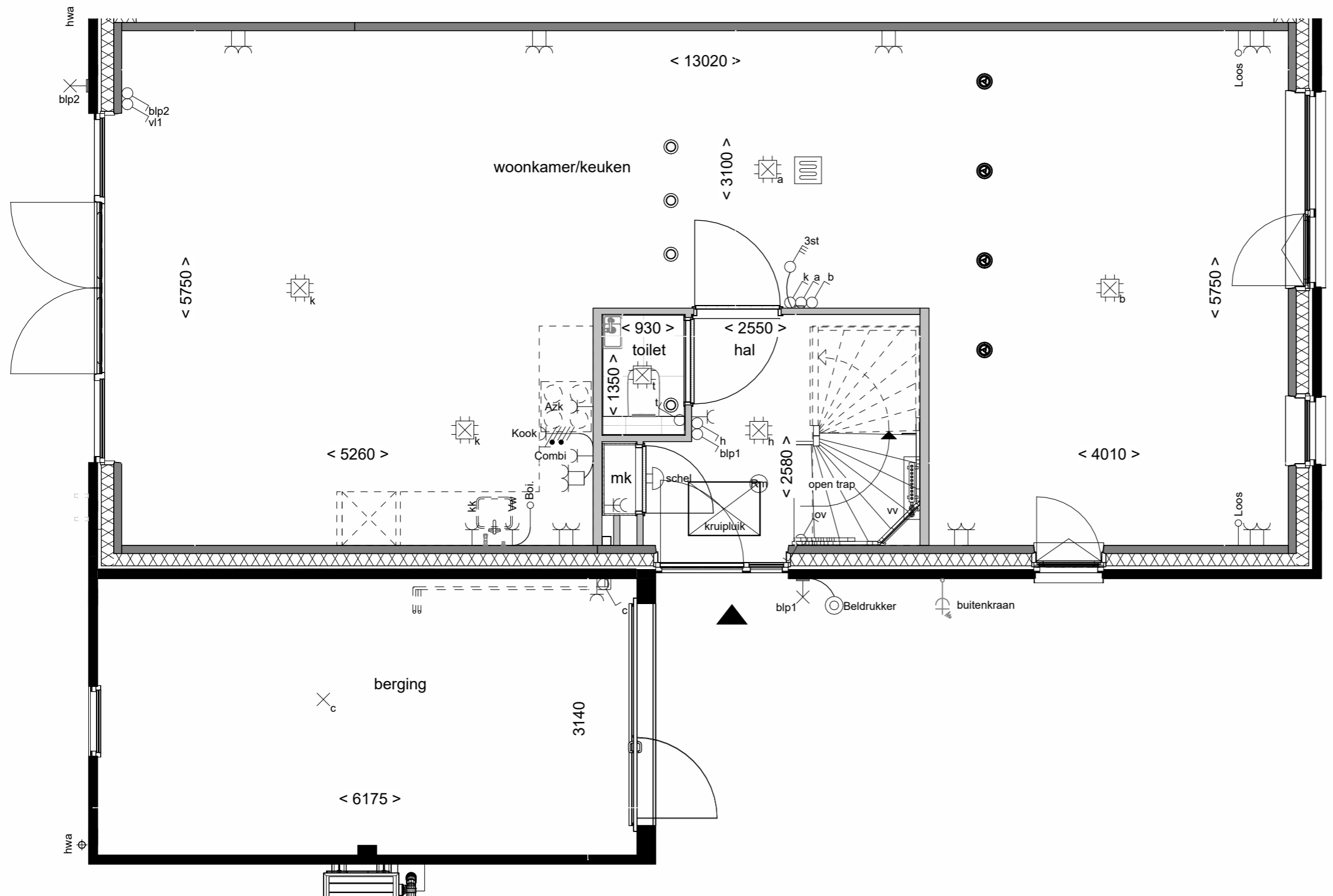

Linkerzijgevel schaal 1:100



vorstvrij buitenkraan  
naast voordeur

Tekening:

Woningtype: E60

Bouwnummer: 02-07,10-13,16,17

Optienummer: 2.K.0.40

Bladformaat: A3

Schaal: 1:50 / 1:100

Datum: 21-04-2026

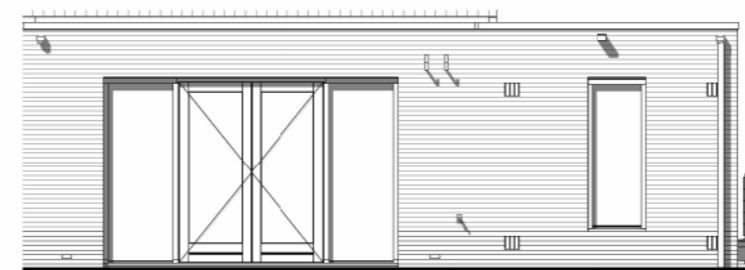
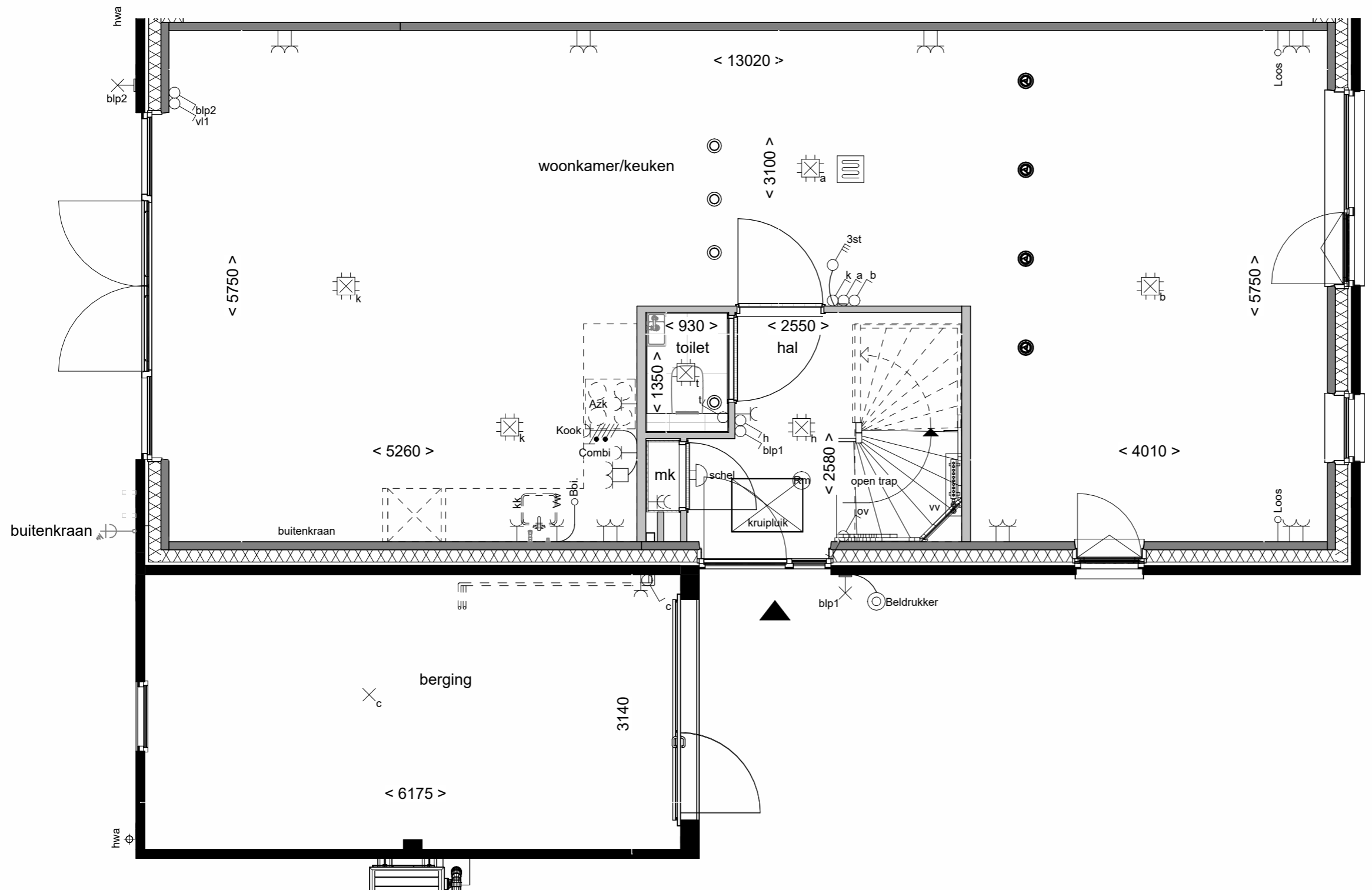

Achtergevel schaal 1:100



vorstvrij buitenkraan  
achter

Tekening:

Woningtype: E60

Bouwnummer: 02-07,10-13,16,17

Optienummer: 2.K.0.44

Bladformaat: A3

Schaal: 1:50 / 1:100

Datum: 21-04-2026

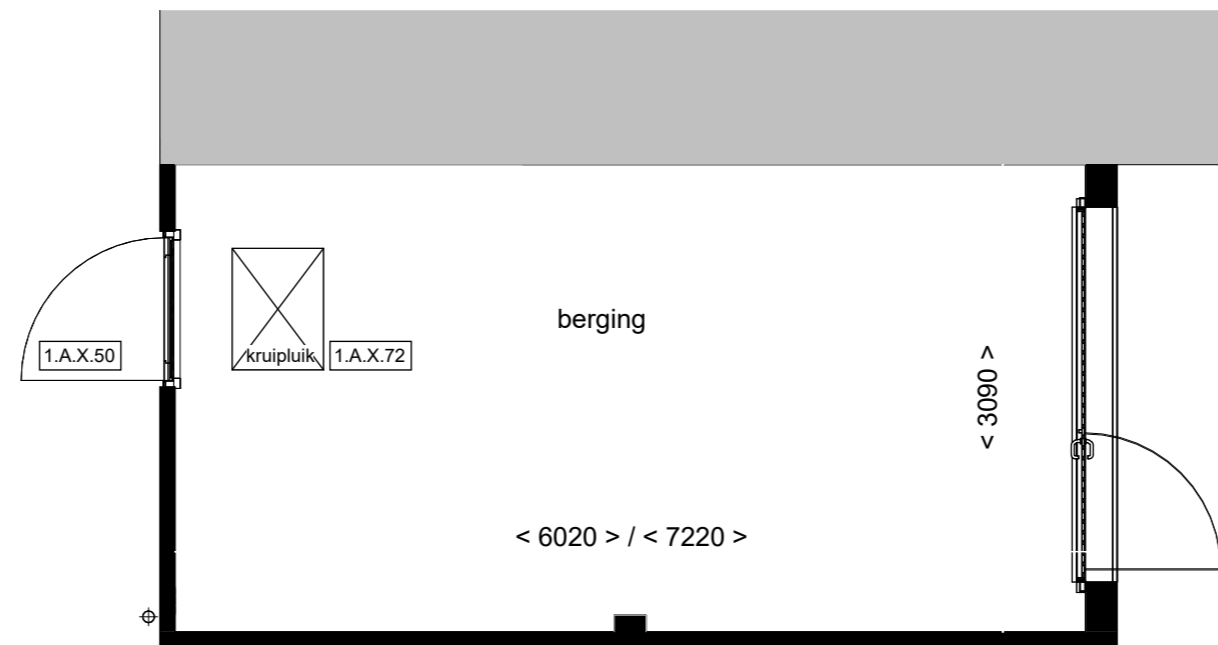

**Wonen aan  
de Gantel**

**Kruipluik in de  
berging**

Tekening:

Woningtype: E60/F60/F60+/F60D

Bouwnummer: 1 t/m 20

Optienummer: 1.A.X.50 / 1.A.X.72

Bladformaat: A3

Schaal: 1 : 50

Datum: 21-04-2026

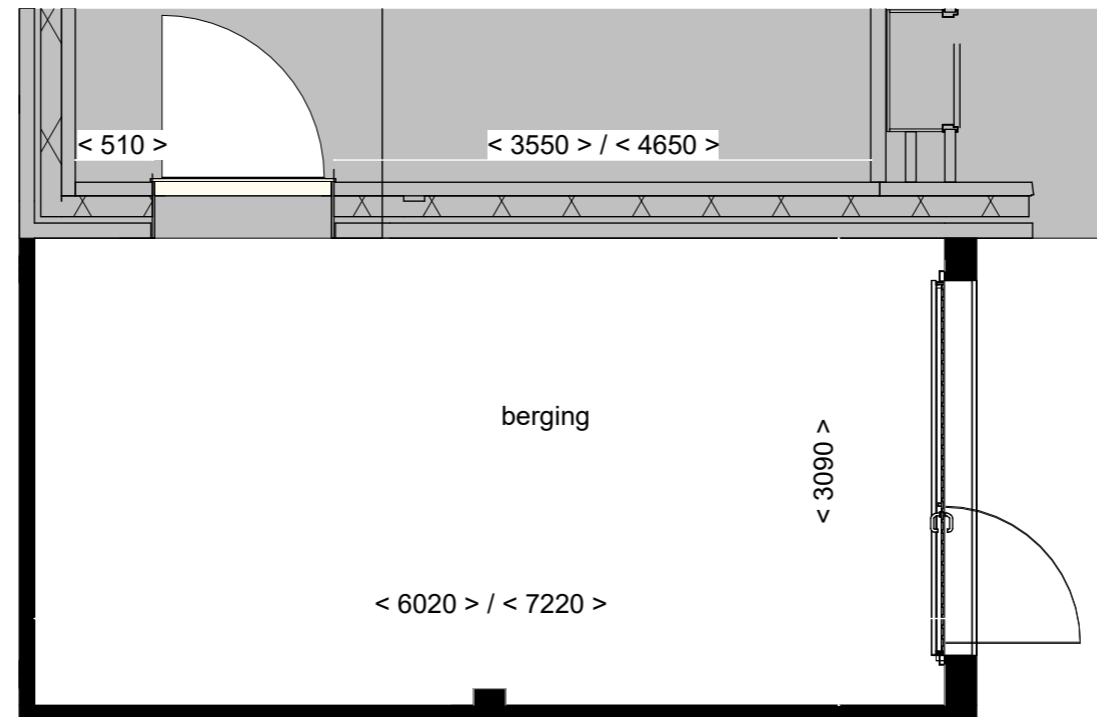

Tekening: Buitendeur tussen woning en berging

Woningtype: E60/F60/F60+

Bouwnummer: 1 t/m 19

Optienummer: 1.A.X.74 B

Bladformaat: A3

Schaal: 1 : 50

Datum: 21-04-2026

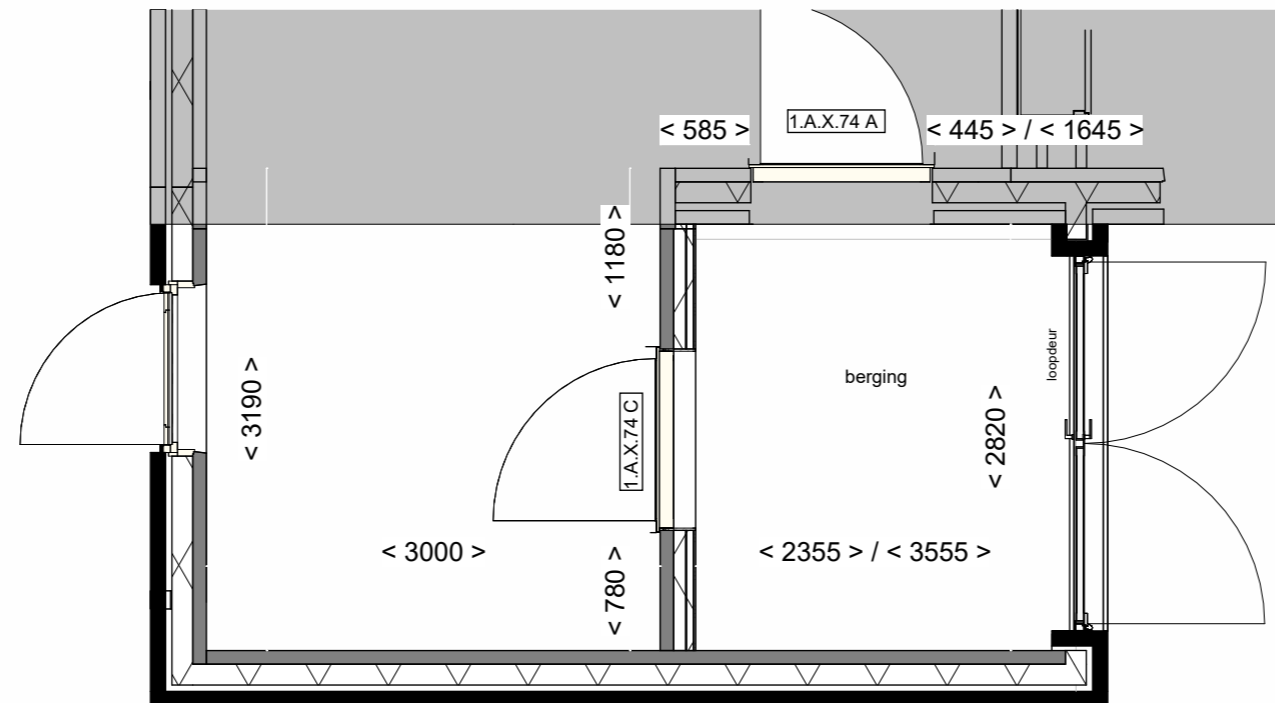

Voorgevel schaal 1:100



Buitendeur tussen  
woning en berging

Tekening:

Woningtype: E60/F60/F60+

Bouwnummer: 1 t/m 19

Optienummer: 1.A.X.74 C

Bladformaat: A3

Schaal: 1:50

Datum: 21-04-2026

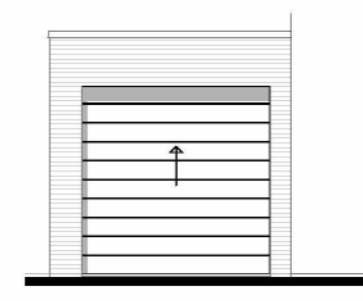
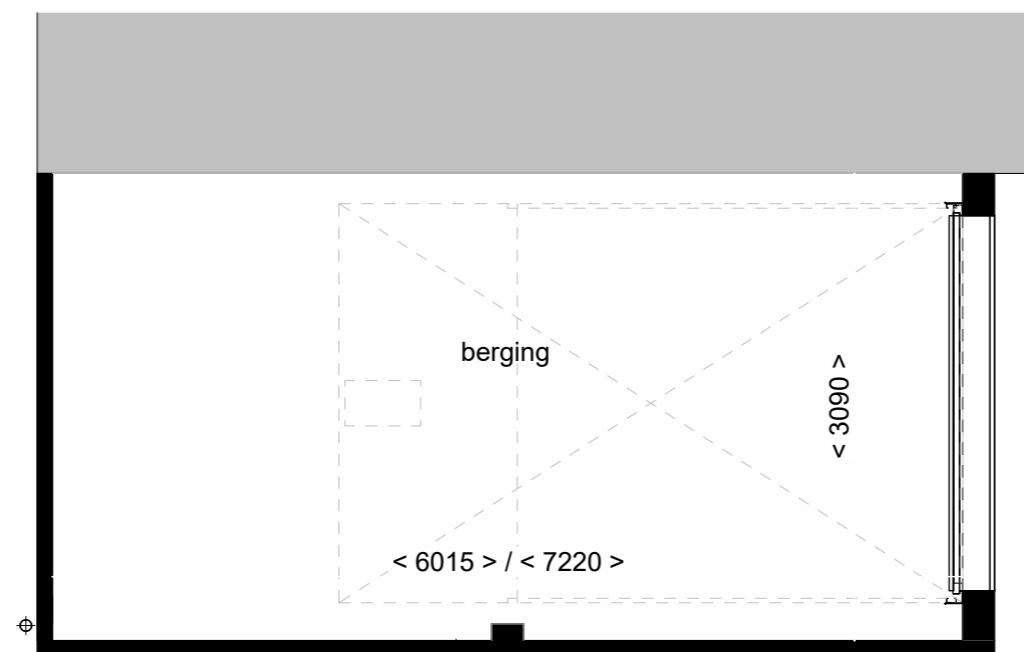

Voorgevel schaal 1:100



**Wonen aan  
de Gantel**

Sectionaaldeur ipv  
kanteldeur

Tekening:

Woningtype: E60/F60/F60+/F60D

Bouwnummer: 1 t/m 20

Optienummer: 1.A.X.80

Bladformaat: A3

Schaal: 1:50

Datum: 21-04-2026

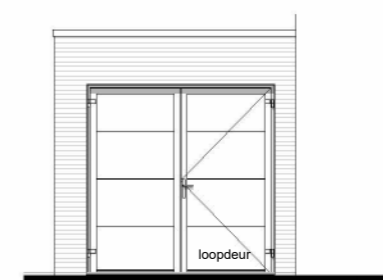
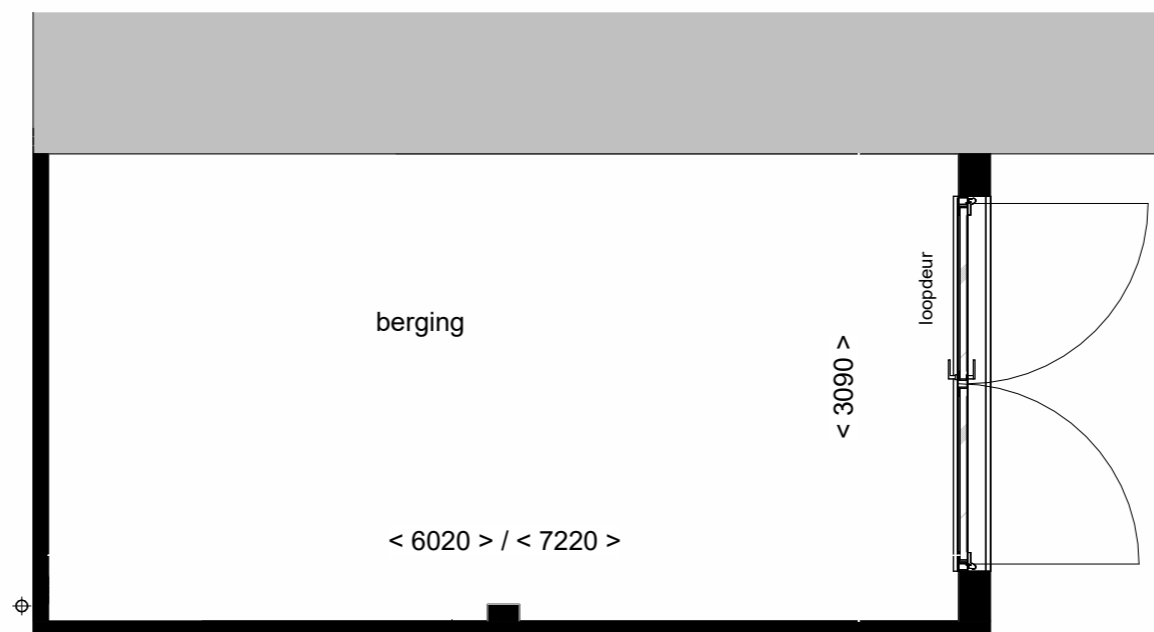

Voorgevel schaal 1:100



**Wonen aan  
de Gantel**

Dubbele

Tekening: openslaande deuren

Woningtype: E60/F60/F60+/F60D

Bouwnummer: 1 t/m 20

Optienummer: 1.A.X.84

Bladformaat: A3

Schaal: 1:50

Datum: 21-04-2026

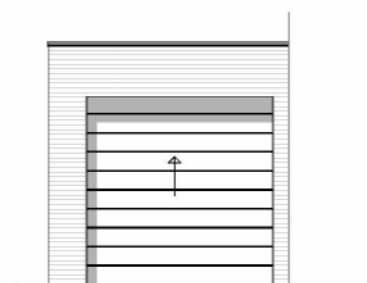
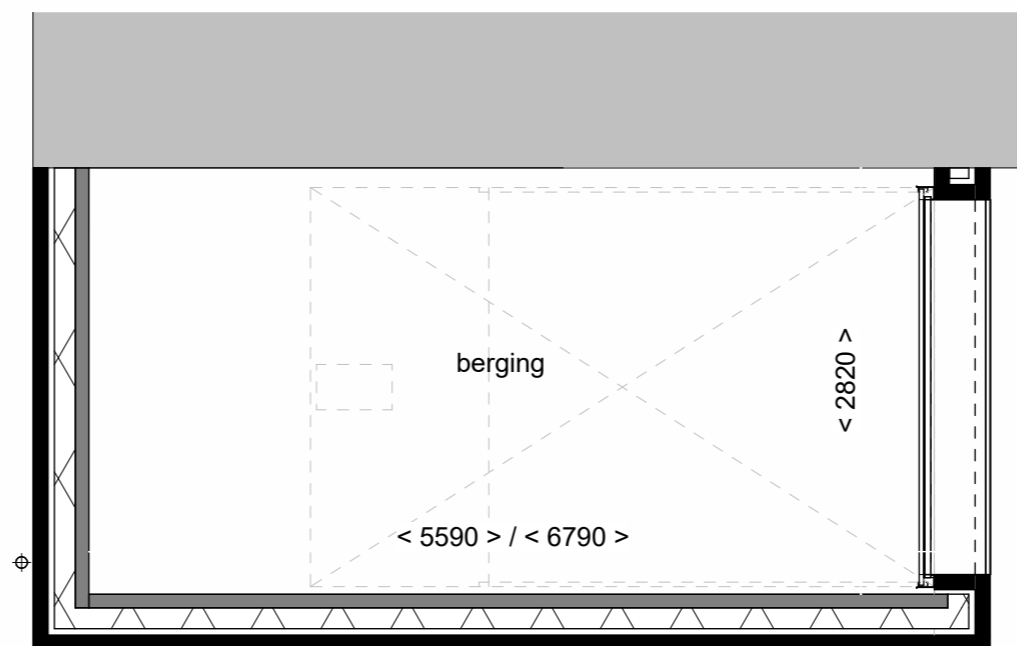

Voorgevel schaal 1:100



Achtergevel schaal 1:100



**Wonen aan  
de Gantel**

Tekening: **Isoleren berging**

Woningtype: **E60/F60/F60+/F60D**

Bouwnummer: **01 t/m 20**

Optienummer: **1.A.X.86**

Bladformaat: **A3**

Schaal: **1:50**

Datum: **21-04-2026**

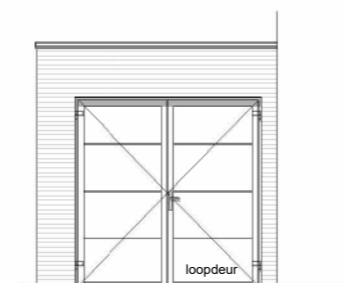
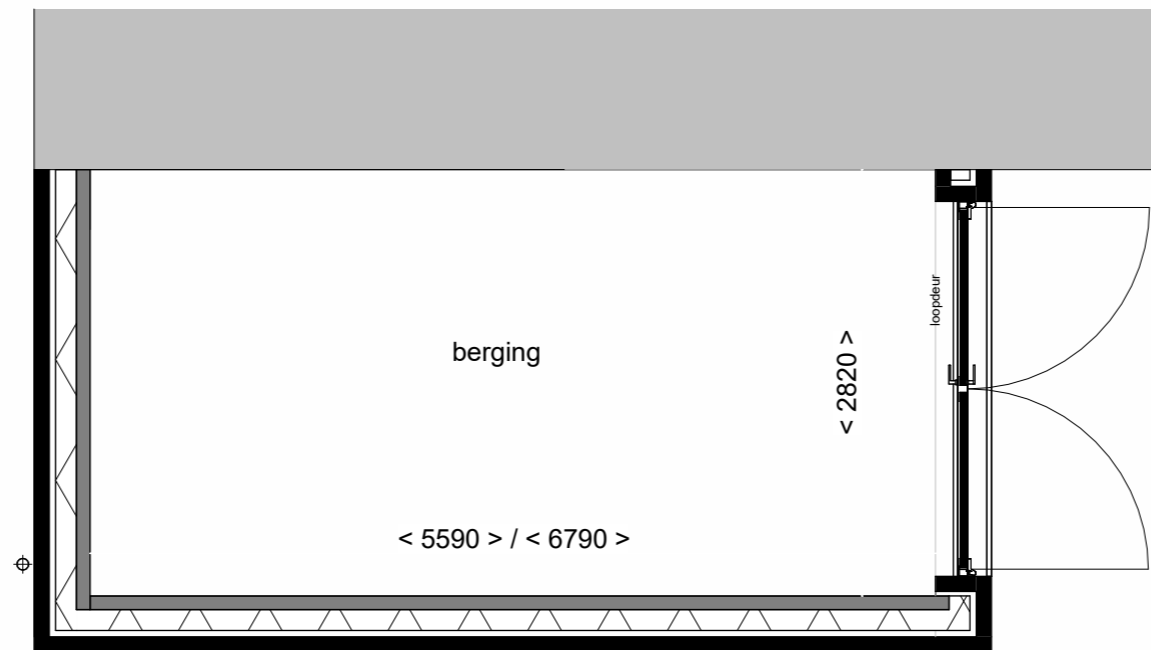

Voorgevel schaal 1:100



Achtergevel schaal 1:100



**Wonen aan  
de Gantel**

Dubbele deuren,  
isoleren

Tekening:

Woningtype: E60/F60/F60+/F60D

Bouwnummer: 1 t/m 20

Optienummer: 1.A.X.94

Bladformaat: A3

Schaal: 1:50

Datum: 21-04-2026