

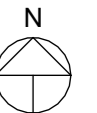

Renvooi

-  - entree woongebouw
-  - erfgrans
-  - parkeervak eigen terrein
-  - parkeervak openbaar
-  - houten vlonder
-  - pergola
-  - haag laag
-  - haag hoog
-  - water
-  - openbaar groen
-  - wandelpad houtsnippers
-  - voetpad
-  - inrit
-  - straat
-  - talud
-  - boom, positie in overleg met koper
-  - indicatie positie riolering
-  - zone erfdienstbaarheid
-  - klinkerbestrating

parkeerplekken en posities bomen indicatief



Tekening: **Situatie totaal**

Woningtype: **E60,E60D,F60,F60+**

Bouwnummer: **1 t/m 31**

Bladnummer: **VT-S-00**

Bladformaat: **A3**

Schaal: **1:750**

Datum: **21-04-2026**

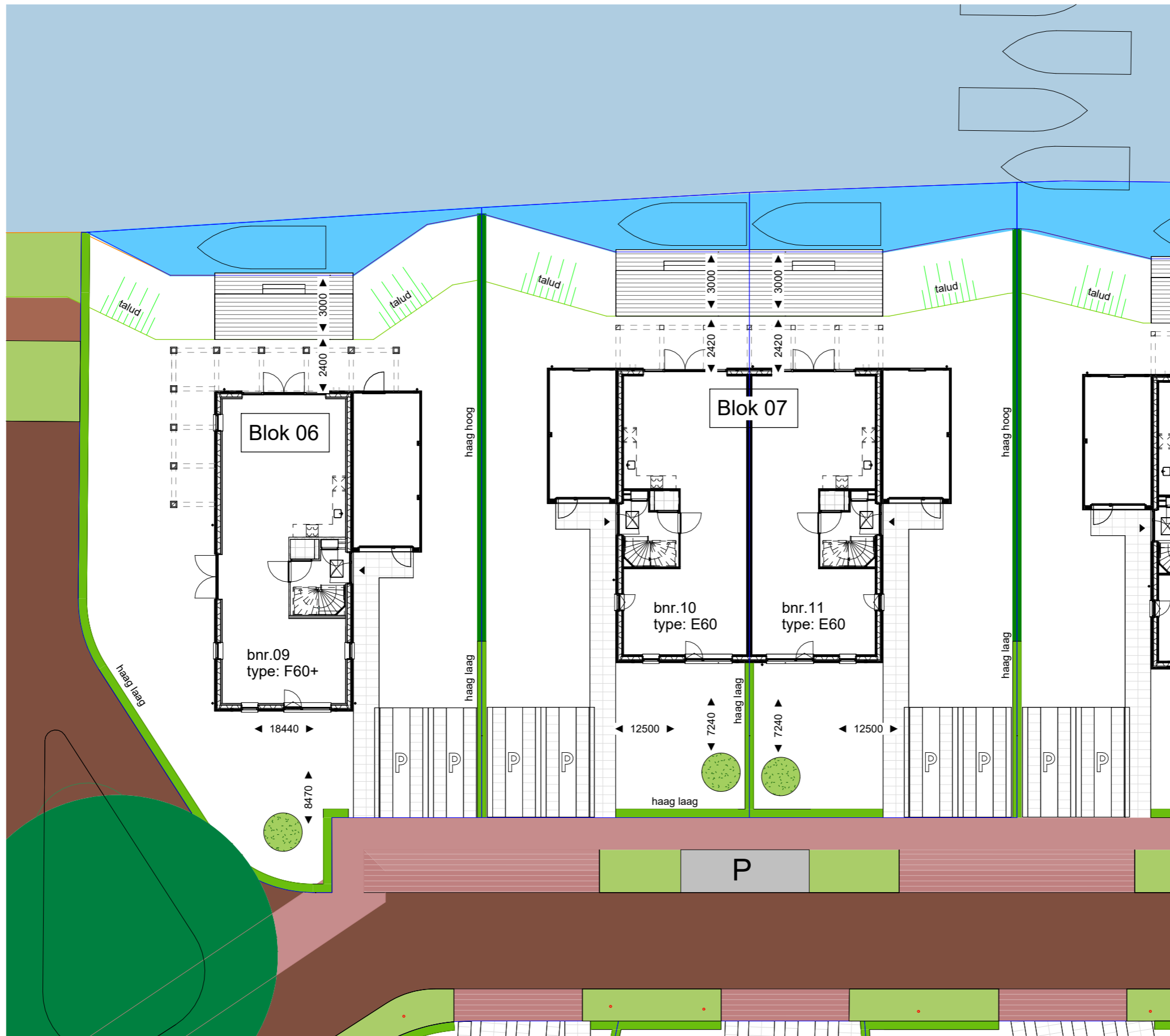

Renvooi

-  - entree woongebouw
-  - erfgrans
-  - parkeervak eigen terrein
-  - parkeervak openbaar
-  - houten vlonder
-  - pergola
-  - haag laag
-  - haag hoog
-  - water
-  - openbaar groen
-  - wandelpad houtsnippers
-  - voetpad
-  - straat
-  - talud
-  - boom, positie in overleg met koper
-  - indicatie positie riolering
-  - zone erfdienstbaarheid
-  - klinkerbestrating

parkeerplekken en posities bomen indicatief

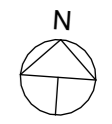

Tekening: **Situatie bnr. 9-11**

Woningtype: **E60, E60D, F60+**

Bouwnummer: **9, 10, 11**

Bladnummer: **VT-S-03**

Bladformaat: **A3**

Schaal: **1:200**

Datum: **21-04-2026**

Renvooi materialen



dakpan antracietgrijs



metselwerk kleur grijswit gesinterd
code A: EN1166 WF WS



metselwerk kleur bruin nuance
code B: HM1106 WF WS



metselwerk kleur bruin caramel
code C: EN1165 WF WS



gevelbetimmering vuren vergrijsd

Renvooi bouwkundig



entree woning



metselwerk

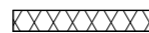

isolatie



dragende wand



niet dragende binnenwand

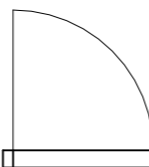

buitendeur

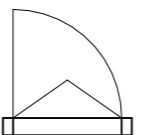

draairaam

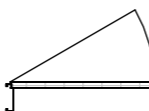

binnendeurkozijn (met bovenlicht)

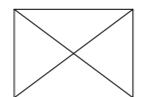

kruipluik



wm opstelplaats wasmachine



wd opstelplaats wasdroger



kk opstelplaats koelkast



principe opstelling keukenblok

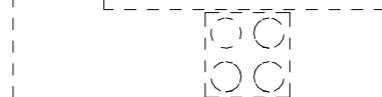

onbenoemde ruimte volgens krijtstreepmethode

Renvooi installaties



aansluitpunt licht, wand



centraaldoos met lichtpunt



armatuur aan de wand



rookmelder



aansluitpunt niet bedraad / loos



aansluitpunt bedraad data, niet afgemonteerd



beldrukker



schel



schakelaar, 1-polig



werkschakelaar tbv PV-panelen



driestandenschakelaar tbv wtw



schakelaar, wissel



schakelaar, serie



pulsschakelaar tbv warmteterugwinunit



wandcontactdoos 1-voudig met beschermingscontact



wandcontactdoos 2-voudig met beschermingscontact



thermostaatleiding, bedraad



wandcontactdoos tbv warmteterugwinunit



wtw mechanische ventilatie-unit incl. warmteterugwinunit



wp warmtepomp



inblaasventiel mechanische ventilatie



afzuigventiel mechanische ventilatie



vv verdeler vloerverwarming



ruimte vzv vloerverwarming



rad elektrische radiator

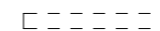

kanalen in het zicht



doucheput



lijngoot douche



buitenkraan

Disclaimer

De op deze tekeningen aangegeven maten zijn circa maten in millimeters en tussen de wanden / vloeren gemeten, waarbij geen rekening is gehouden met enige wandafwerking, plinten, aftimmering, etc. In verband met de nauwkeurige uitwerking van details, constructie, maatvoering, materialen e.d. kunnen er kleine afwijkingen ontstaan ten opzichte van de nu vermelde gegevens. Deze geringe afwijkingen geven geen aanleiding tot verrekening. Aan de op deze tekening aangegeven maten kunnen derhalve geen rechten worden ontleend. De op deze tekeningen aangegeven maatvoering is niet geschikt voor opdrachten aan derden door koper(s). De posities van aansluitingen en installatie onderdelen zijn indicatief op tekening aangegeven. De exacte aantallen en posities zullen na berekening in het werk door de installateurs worden bepaald en kunnen afwijken van deze tekening.



**Wonen aan
de Gantel**

Tekening: **Renvooi**

Woningtype: **E60 / F60 / F60+**

Bouwnummer: **1 t/m 31**

Bladnummer: **VT-0-00c**

Bladformaat: **A3**

Schaal: **1 : 50**

Datum: **21-04-2026**



Voorgevel

Type: F60+
bnr: 9

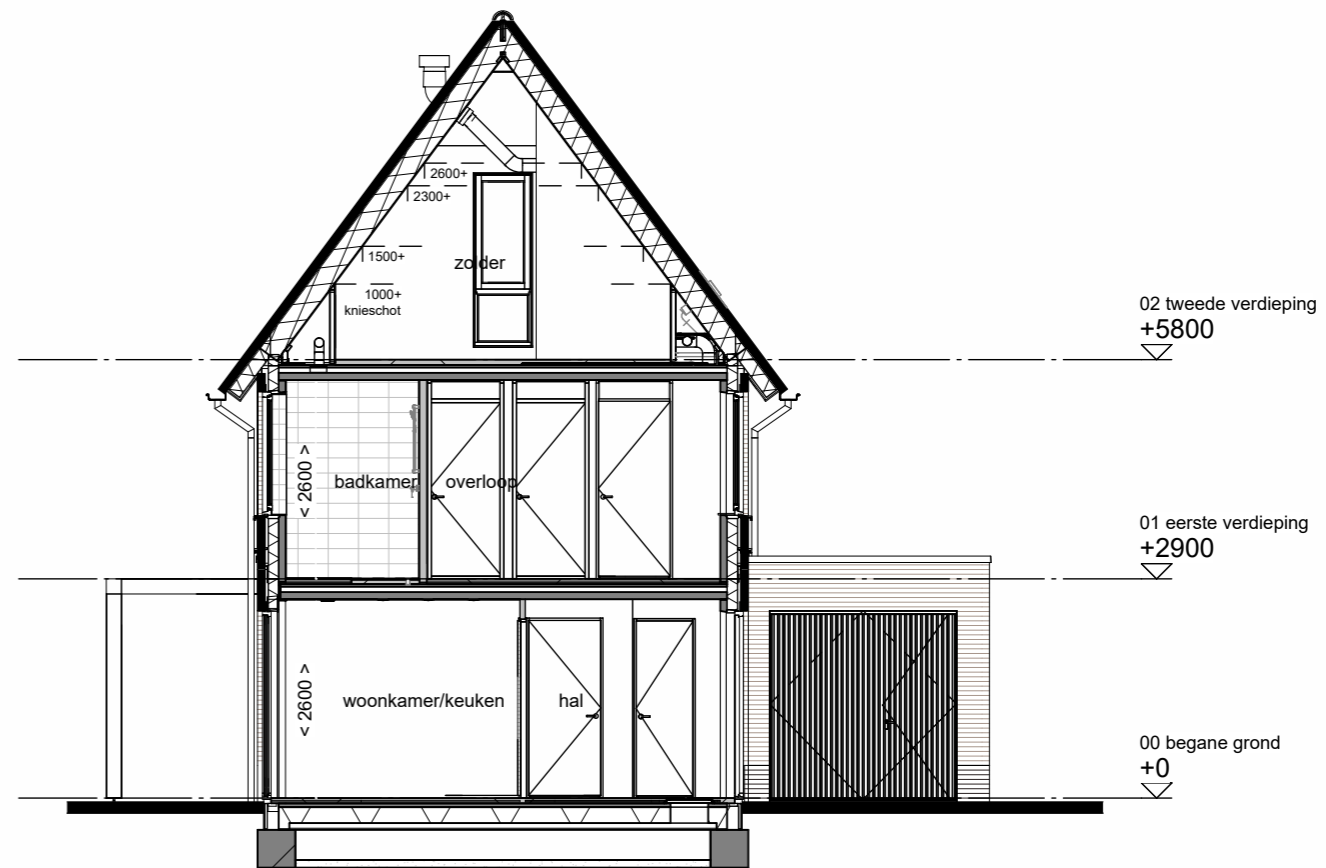

Doorsnede



Achtergevel

Type: F60+
bnr: 9



Tekening: Gevel/Drsn Blok 6

Woningtype: F60+

Bouwnummer: 9

Bladnummer: VT-06-00a

Bladformaat: A3

Schaal: 1 : 100

Datum: 21-04-2026



Linker zijgevel

Type: F60+
bnr: 9



Rechter zijgevel

Type: F60+
bnr: 9



Tekening: Zijgevels blok 6

Woningtype: F60+

Bouwnummer: 9

Bladnummer: VT-06-00b

Bladformaat: A3

Schaal: 1 : 100

Datum: 21-04-2026

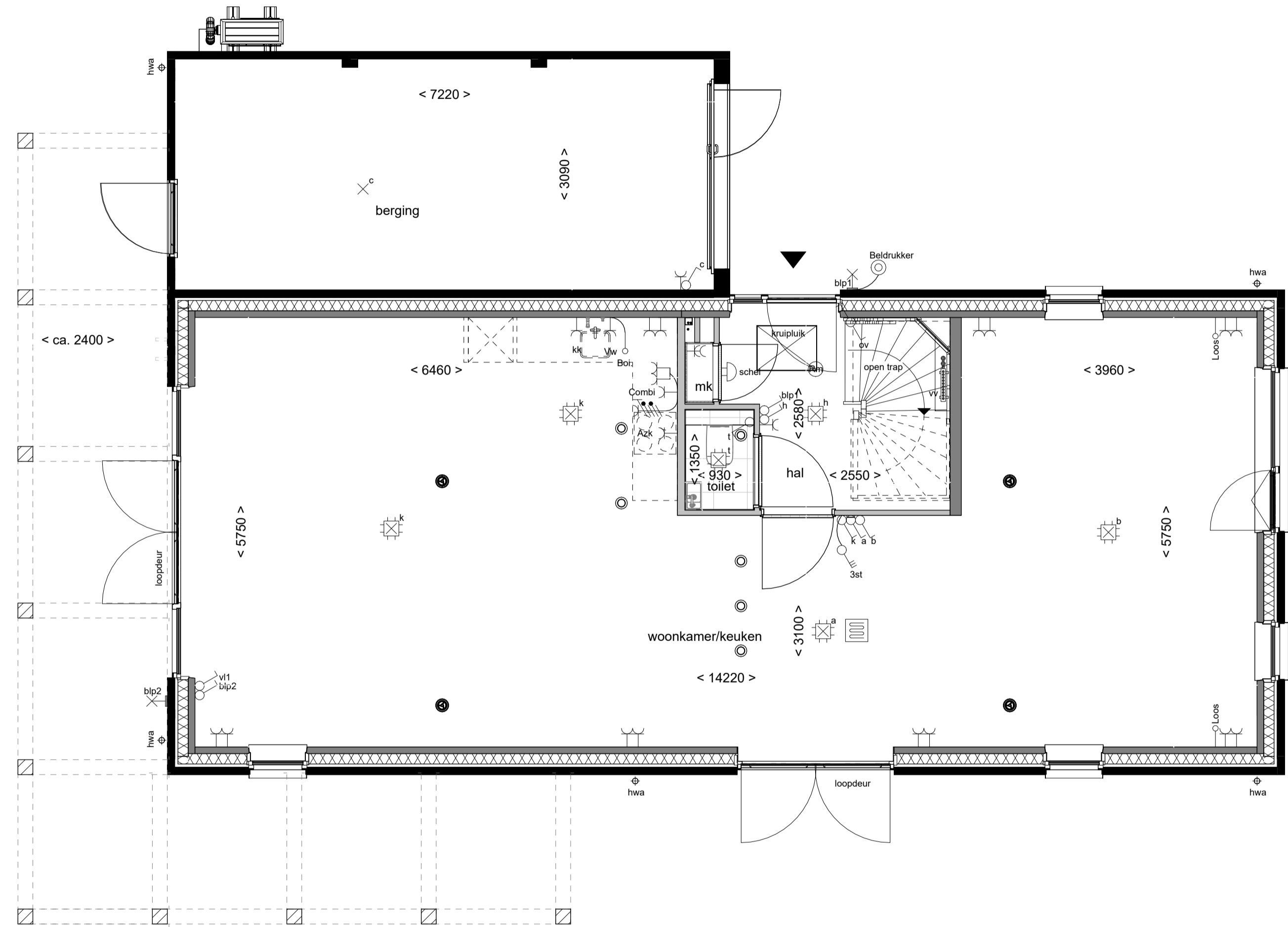
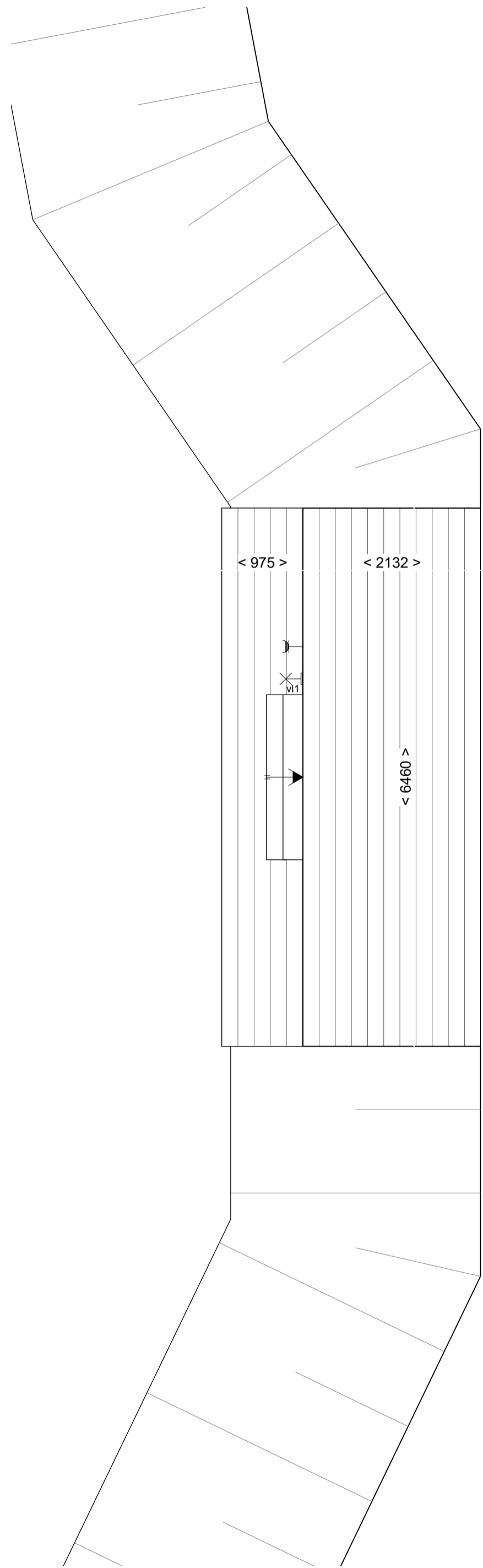

Tekening: **Begane grond**
 Woningtype: **F60+**
 Bouwnummer: **9**
 Bladnummer: **VT-06-09a**
 Bladformaat: **A2**
 Schaal: **1 : 50**
 Datum: **21-04-2026**

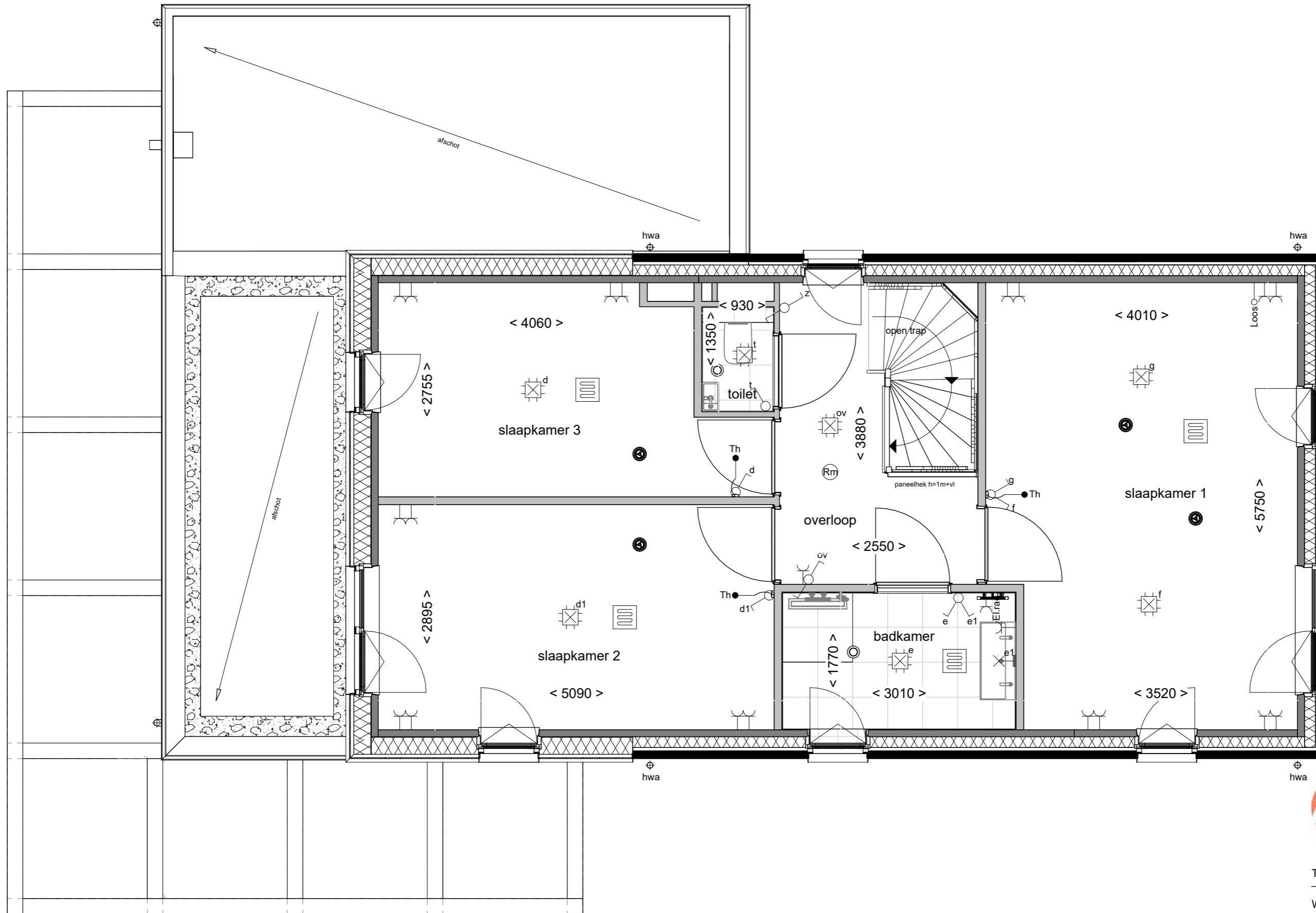

Tekening: **Eerste verdieping**

Woningtype: **F60+**

Bouwnummer: **9**

Bladnummer: **VT-06-09b**

Bladformaat: **A3**

Schaal: **1 : 50**

Datum: **21-04-2026**

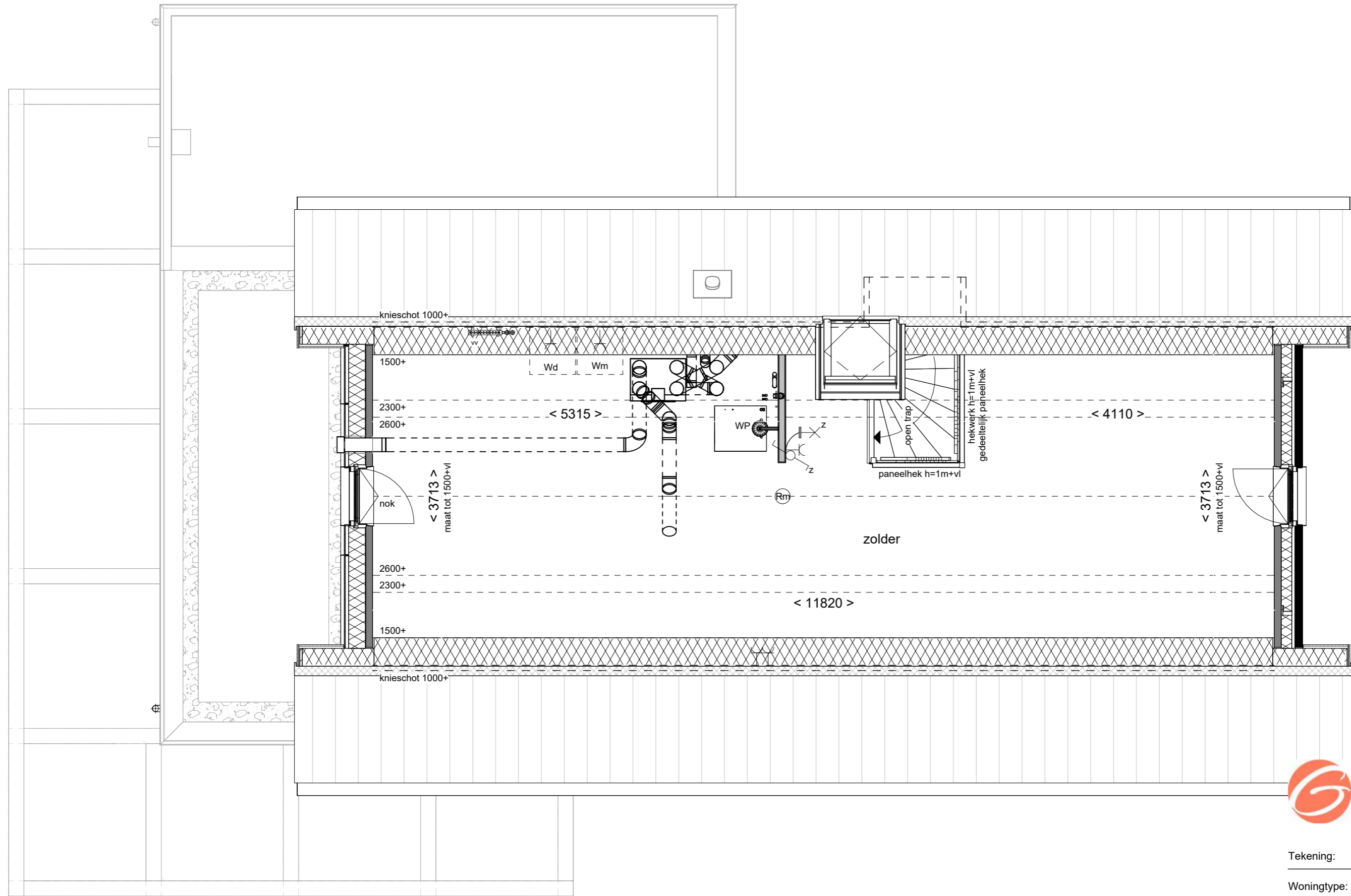

**Wonen aan
de Gantel**

Tekening: **Tweede verdieping**

Woningtype: **F60+**

Bouwnummer: **9**

Bladnummer: **VT-06-09c**

Bladformaat: **A3**

Schaal: **1 : 50**

Datum: **21-04-2026**

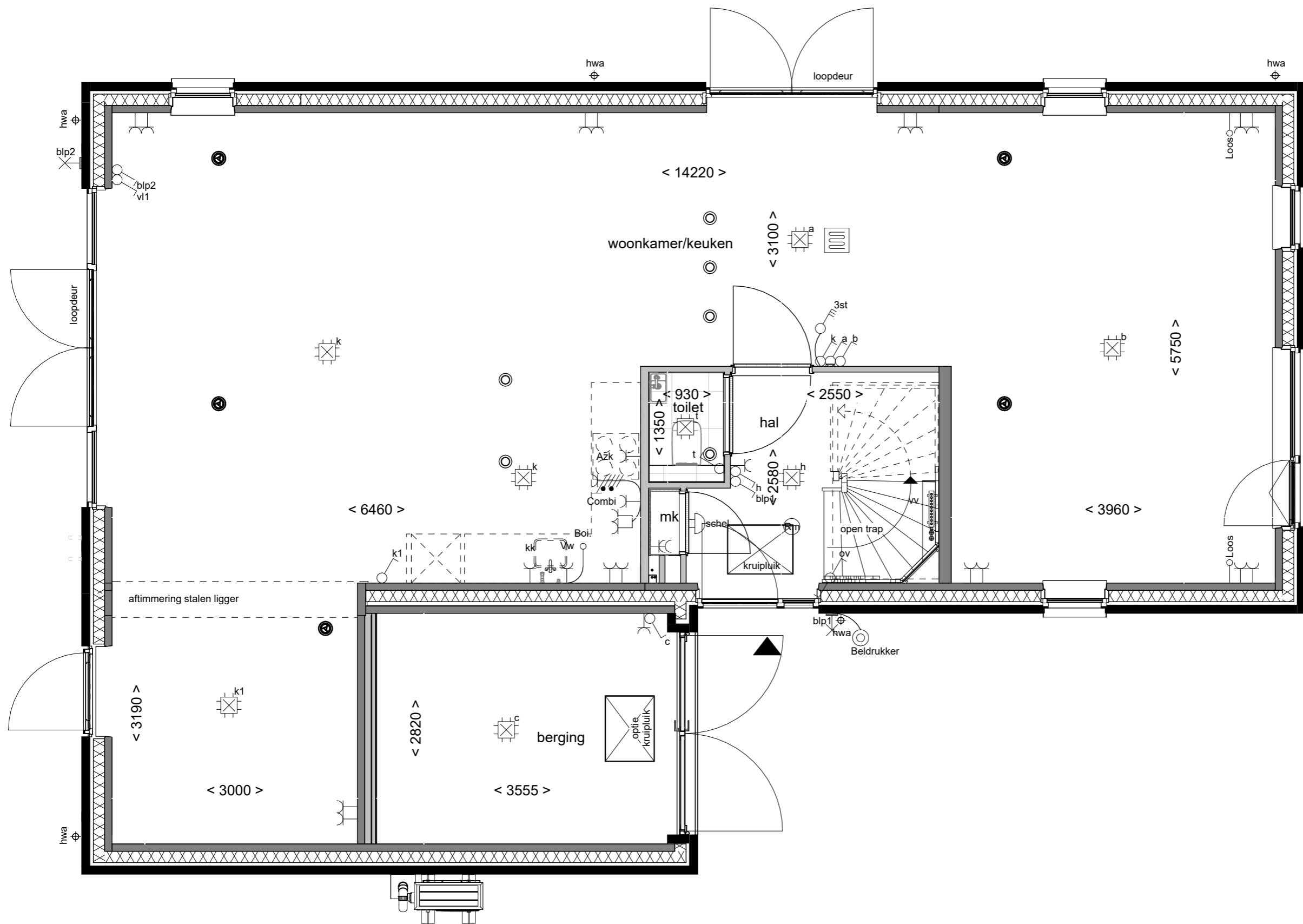

Samenvoegen
berging bij wnk

Tekening: **Wonen aan de Gantel**

Woningtype: F60+

Bouwnummer: 8/9/14/15/18/19

Optienummer: 1.A.F.15

Bladformaat: A3

Schaal: 1 : 50

Datum: 21-04-2026

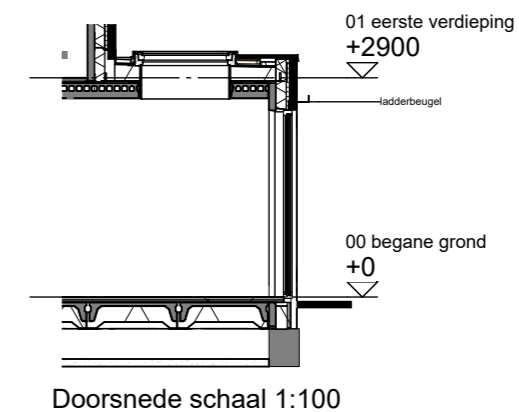
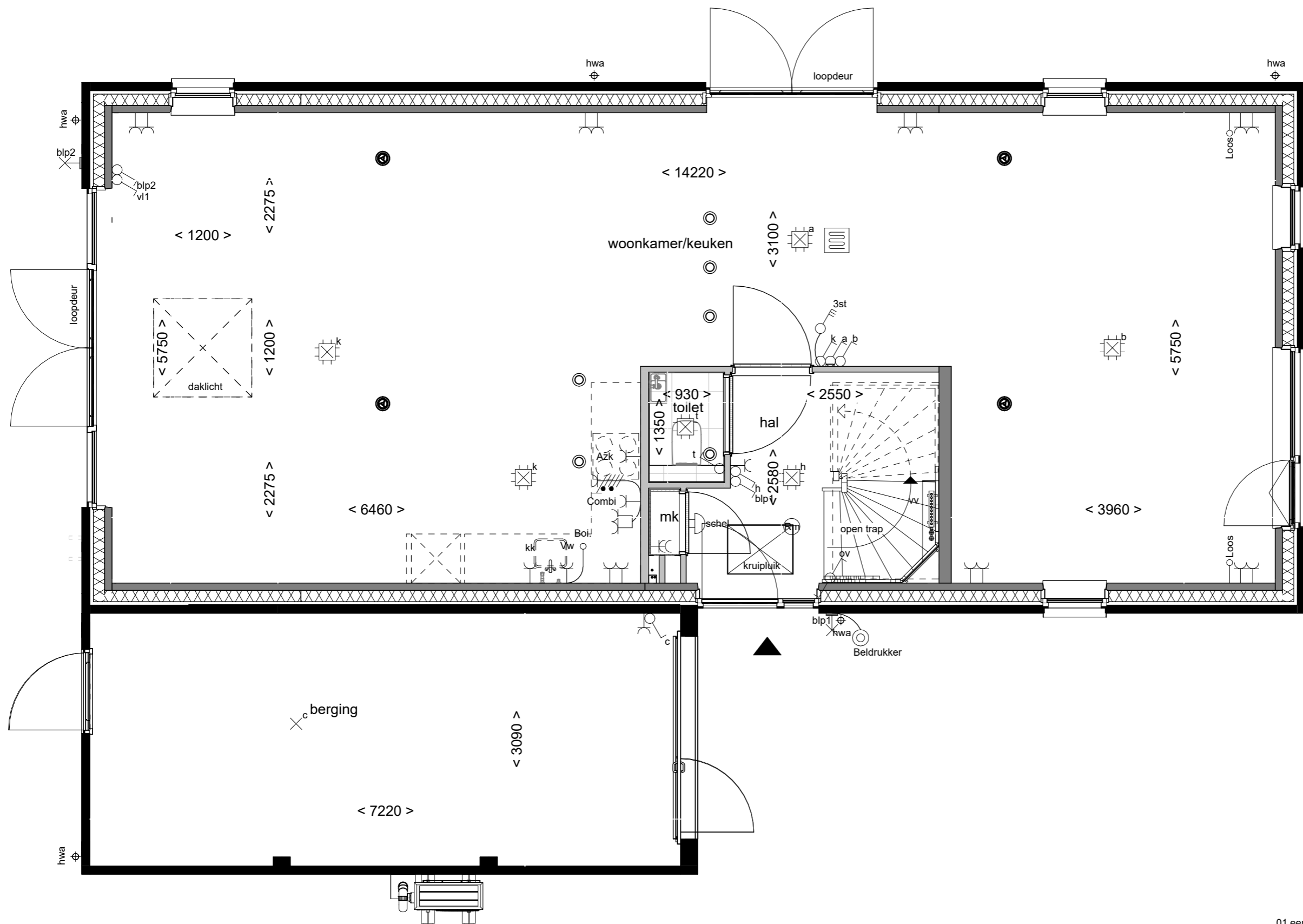

Lichtkoepel in
uitbouw 240cm

Tekening: **Lichtkoepel in uitbouw 240cm**
 Woningtype: **F60+**
 Bouwnummer: **8/9/14/15/18/19**
 Optienummer: **1.B.X.10**
 Bladformaat: **A3**
 Schaal: **1:50 / 1:100**
 Datum: **21-04-2026**

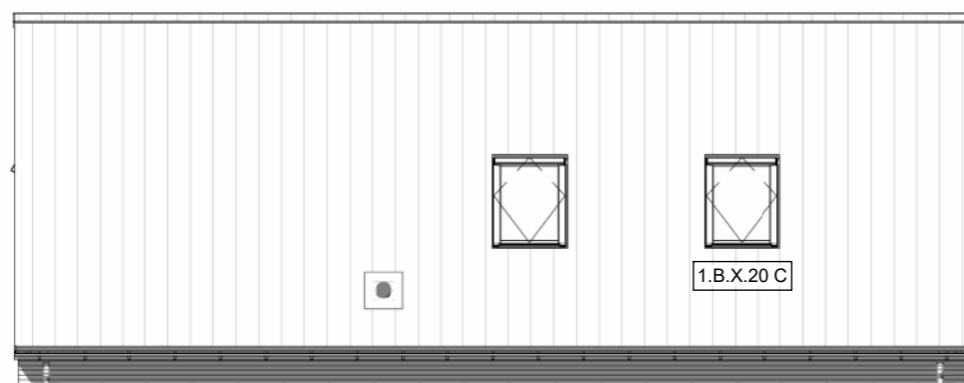
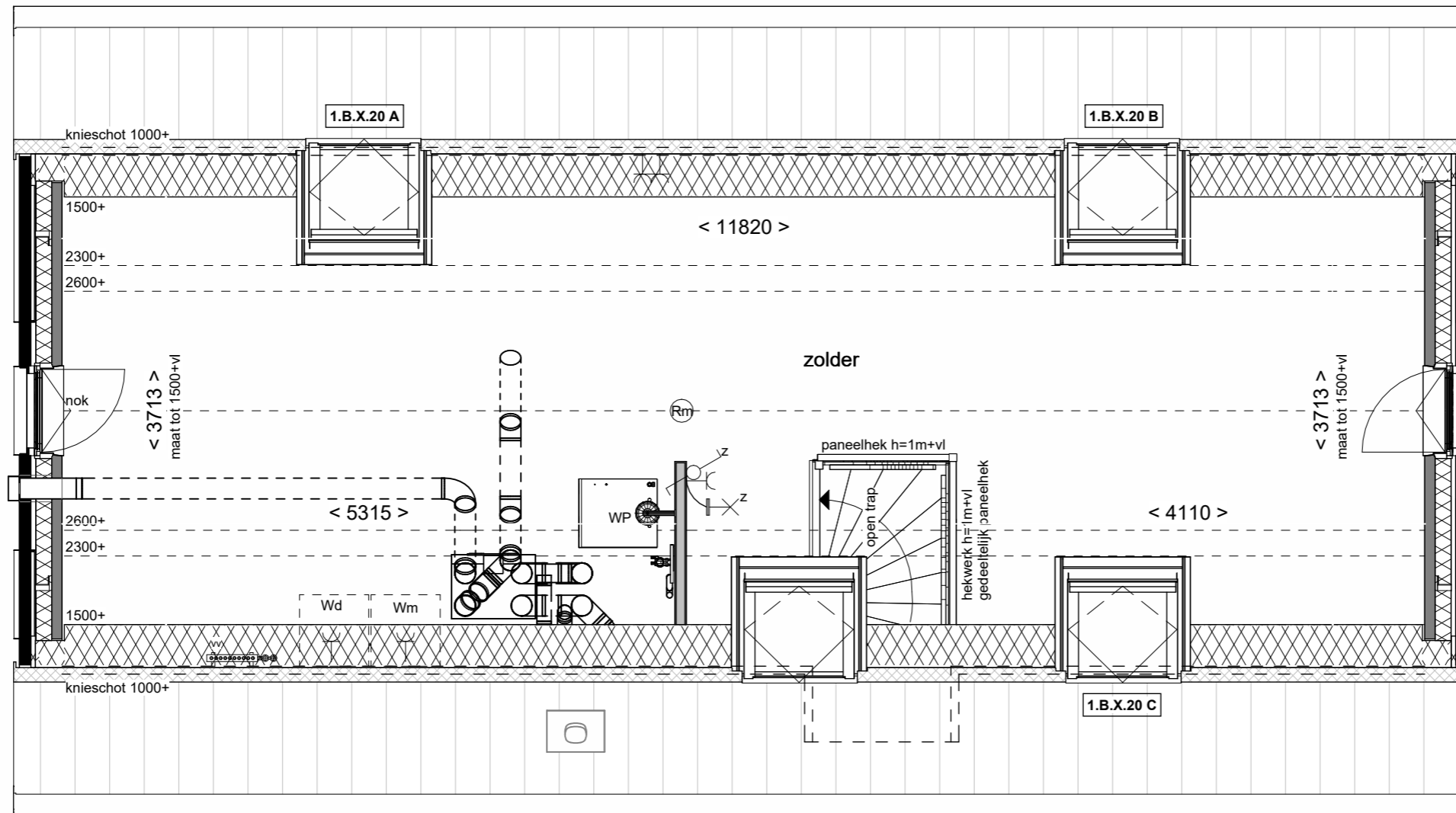

Linkerzijgevel schaal 1:100

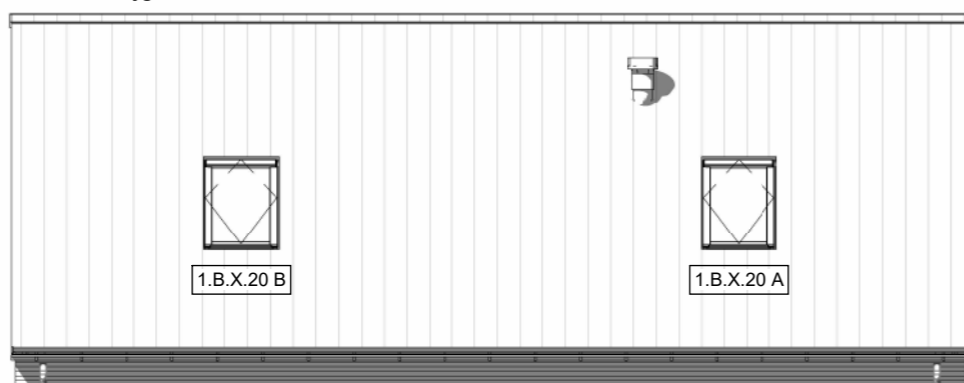

Rechterzijgevel schaal 1:100

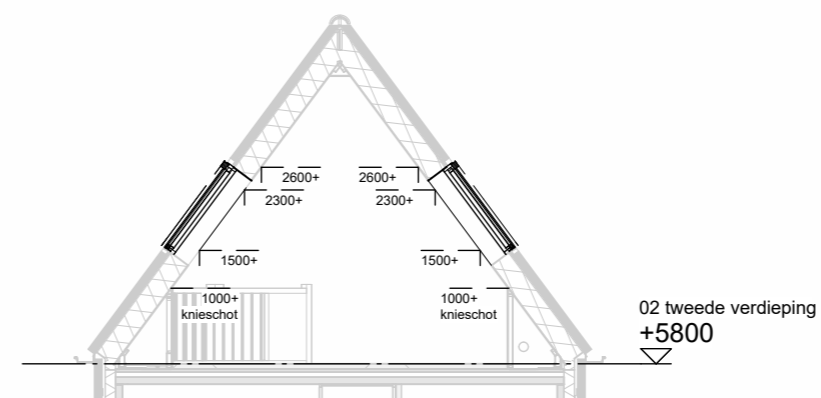

Doorsnede schaal 1:100



Tekening: Dakramen zijgevels

Woningtype: F60+

Bouwnummer: 8/9/14/15/18/19/20

Optienummer: 1.B.X.20

Bladformaat: A3

Schaal: 1:50 / 1:100

Datum: 21-04-2026

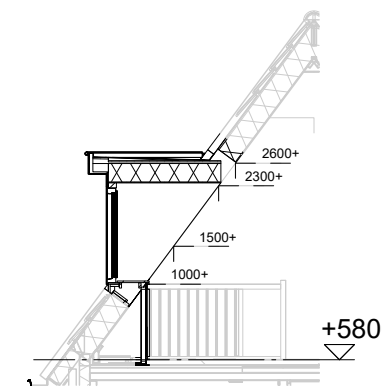
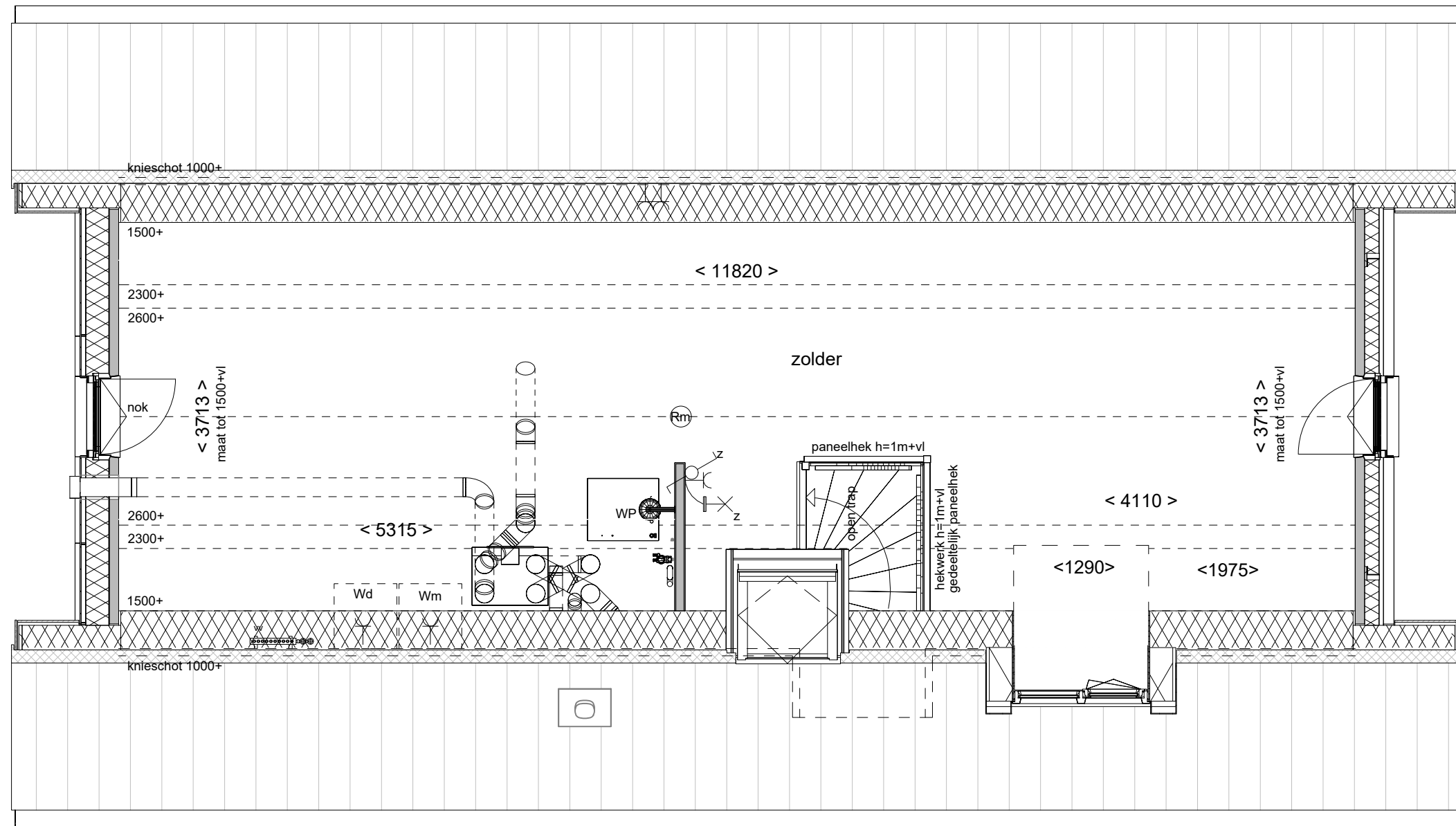

Doorsnede schaal 1:100



Dakkapel zijgevel

Tekening: 130cm

Woningtype: F60+

Bouwnummer: 8/9/14/15/18/19

Optienummer: 1.B.X.36

Bladformaat: A3

Schaal: 1:50 / 1:100

Datum: 21-04-2026

02 tweede verdieping

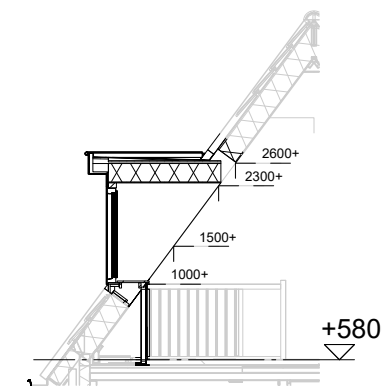
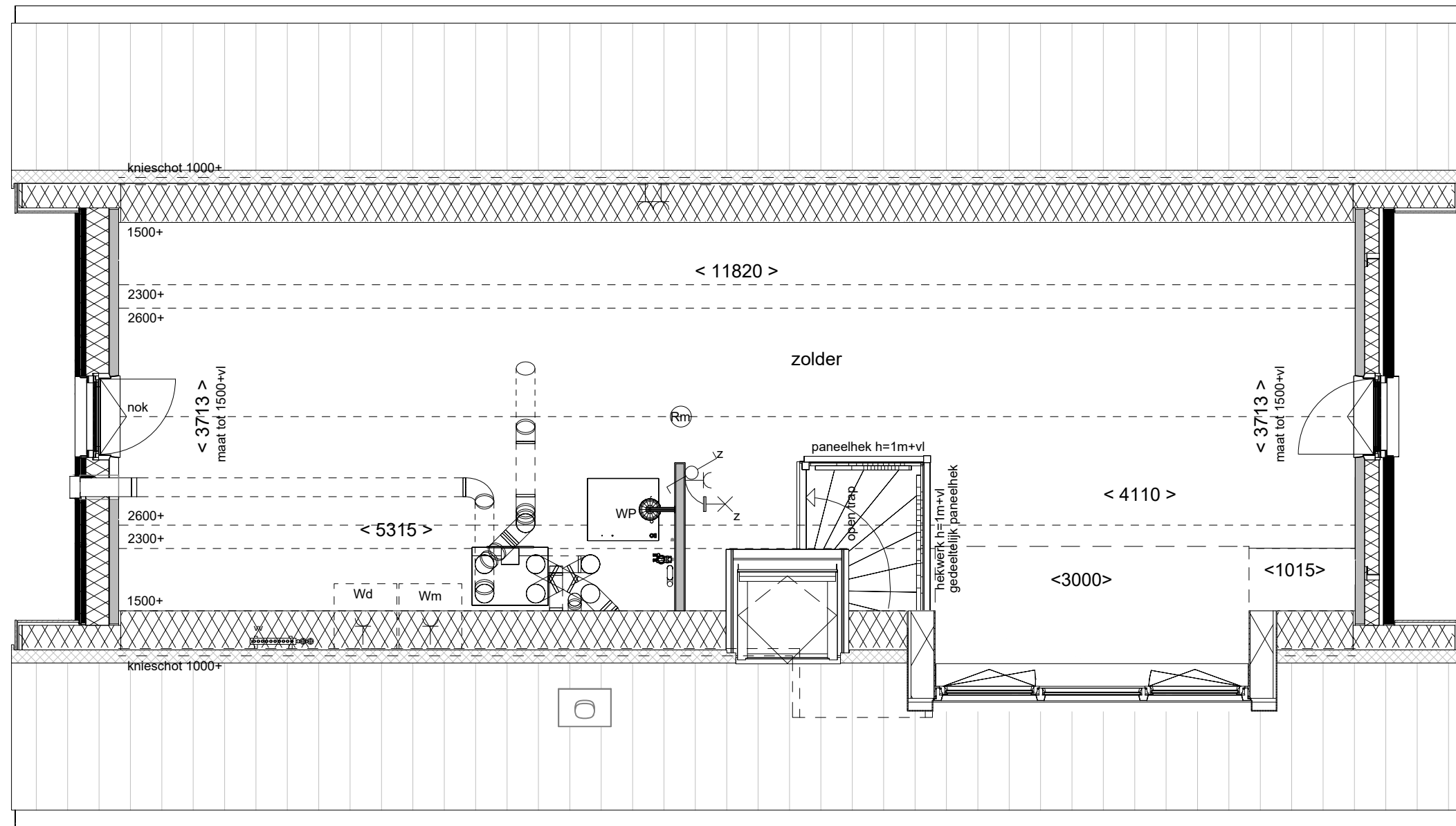

Doorsnede schaal 1:100



Dakkapel zijgevel
300cm

Tekening:

Woningtype: F60+

Bouwnummer: 8/9/14/15/18/19

Optienummer: 1.B.X.38

Bladformaat: A3

Schaal: 1:50 / 1:100

Datum: 21-04-2026

02 tweede verdieping

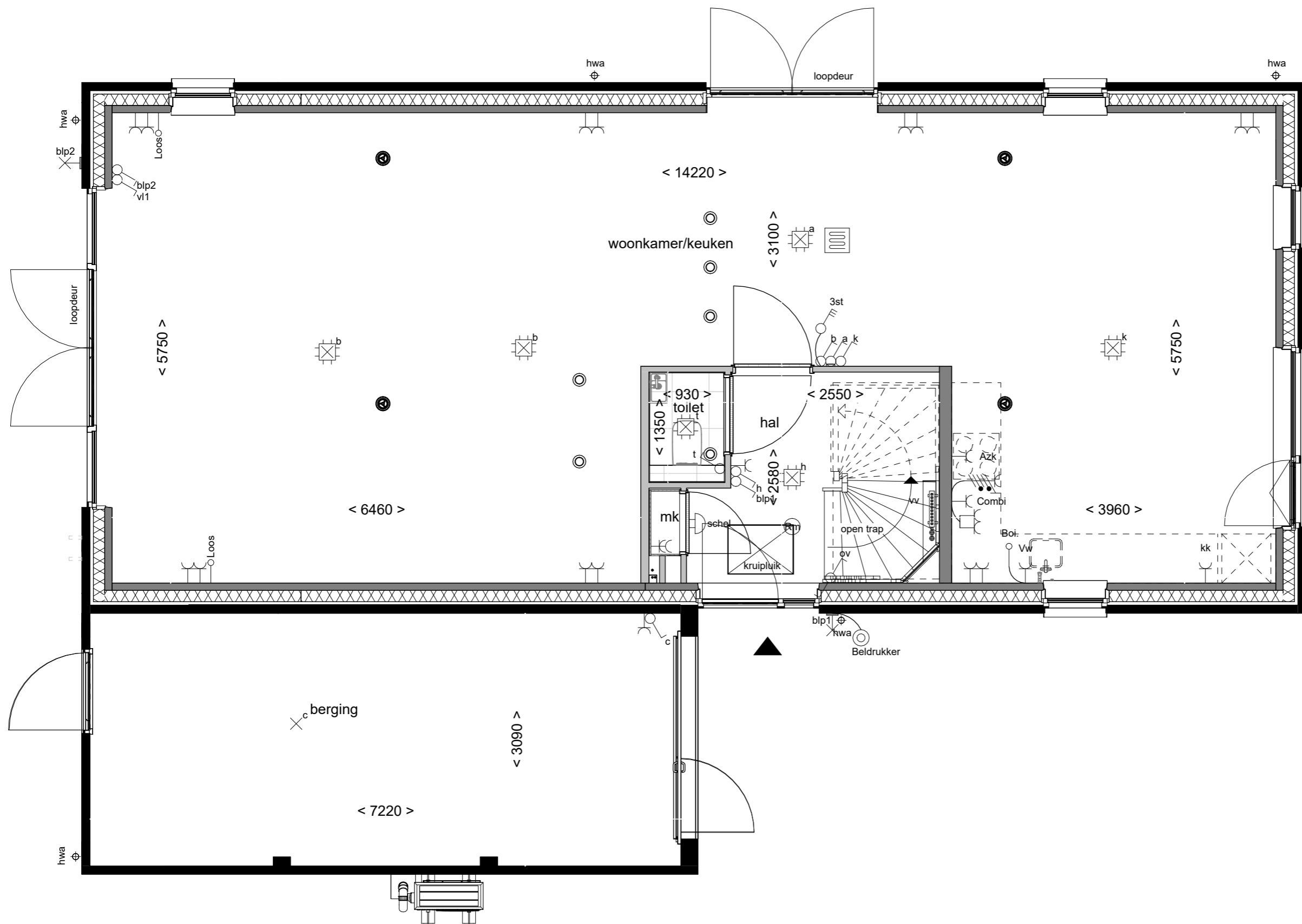

Tekening: Tuingericht wonen

Woningtype: F60+

Bouwnummer: 8/9/14/15/18/19/20

Optienummer: 1.C.F.13

Bladformaat: A3

Schaal: 1:50

Datum: 21-04-2026

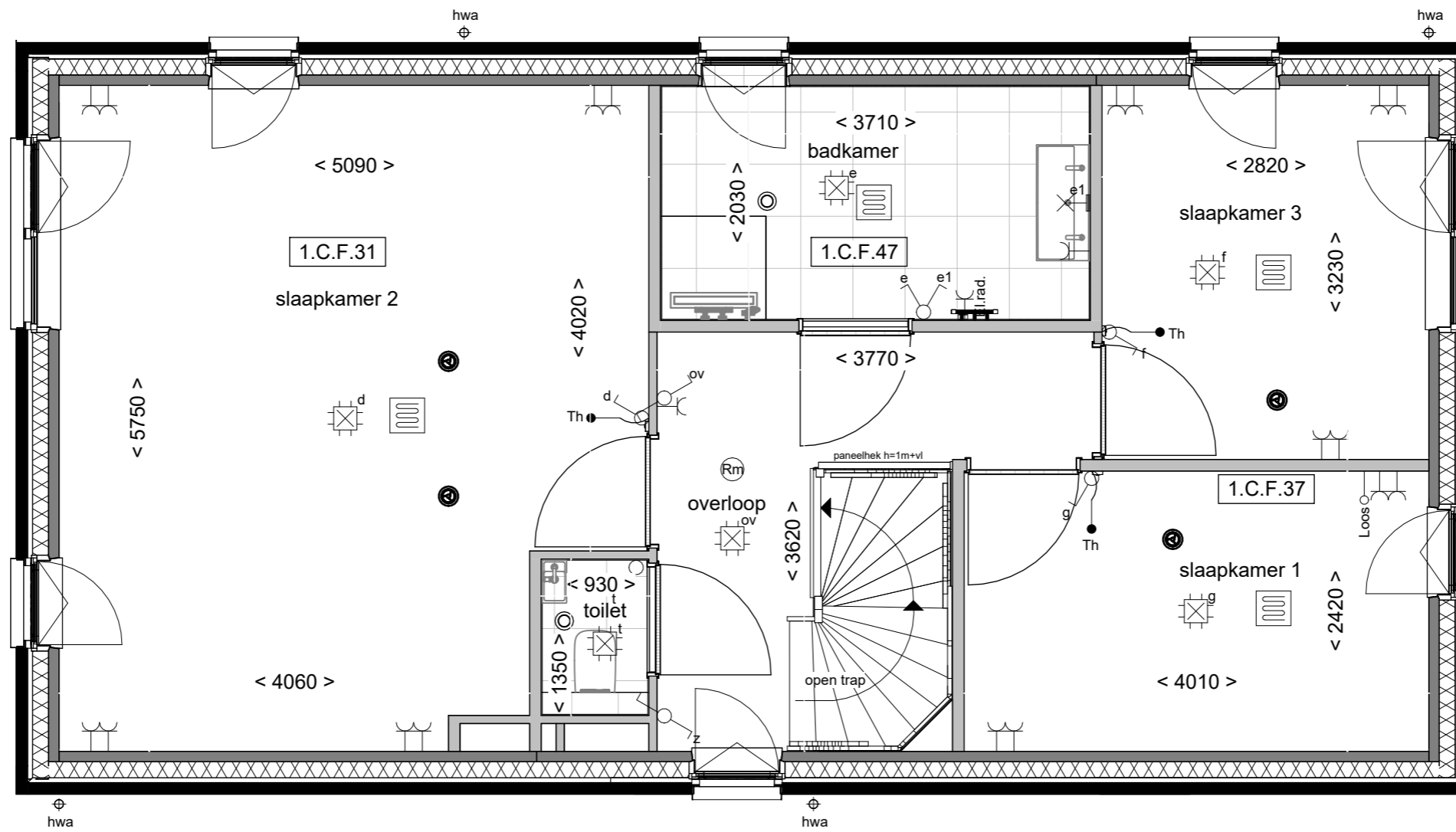

Wonen aan de Gantel
 Vergroten badk.
 indeling 2 slpk voor

Tekening:

Woningtype: F60+

Bouwnummer: 8/9/14/15/18/19/20

Optienummer: 1.C.F.31/-37/-47

Bladformaat: A3

Schaal: 1:50

Datum: 21-04-2026

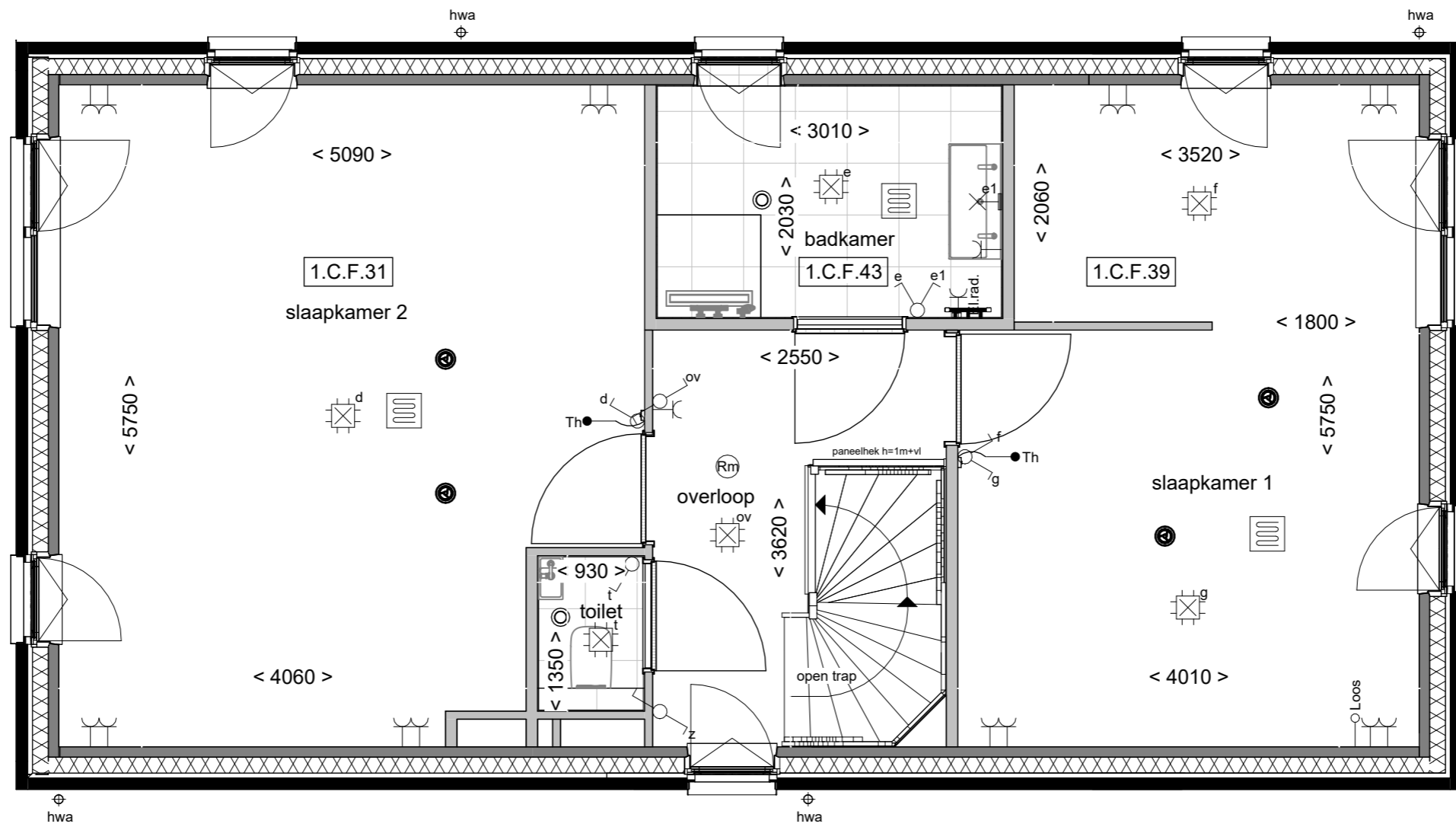

Wonen aan
de Gantel

Tekening: Verbreden badk
inloopk. slpk voor

Woningtype: F60+

Bouwnummer: 8/9/14/15/18/19/20

Optienummer: 1.C.F.31/-39/-43

Bladformaat: A3

Schaal: 1:50

Datum: 21-04-2026

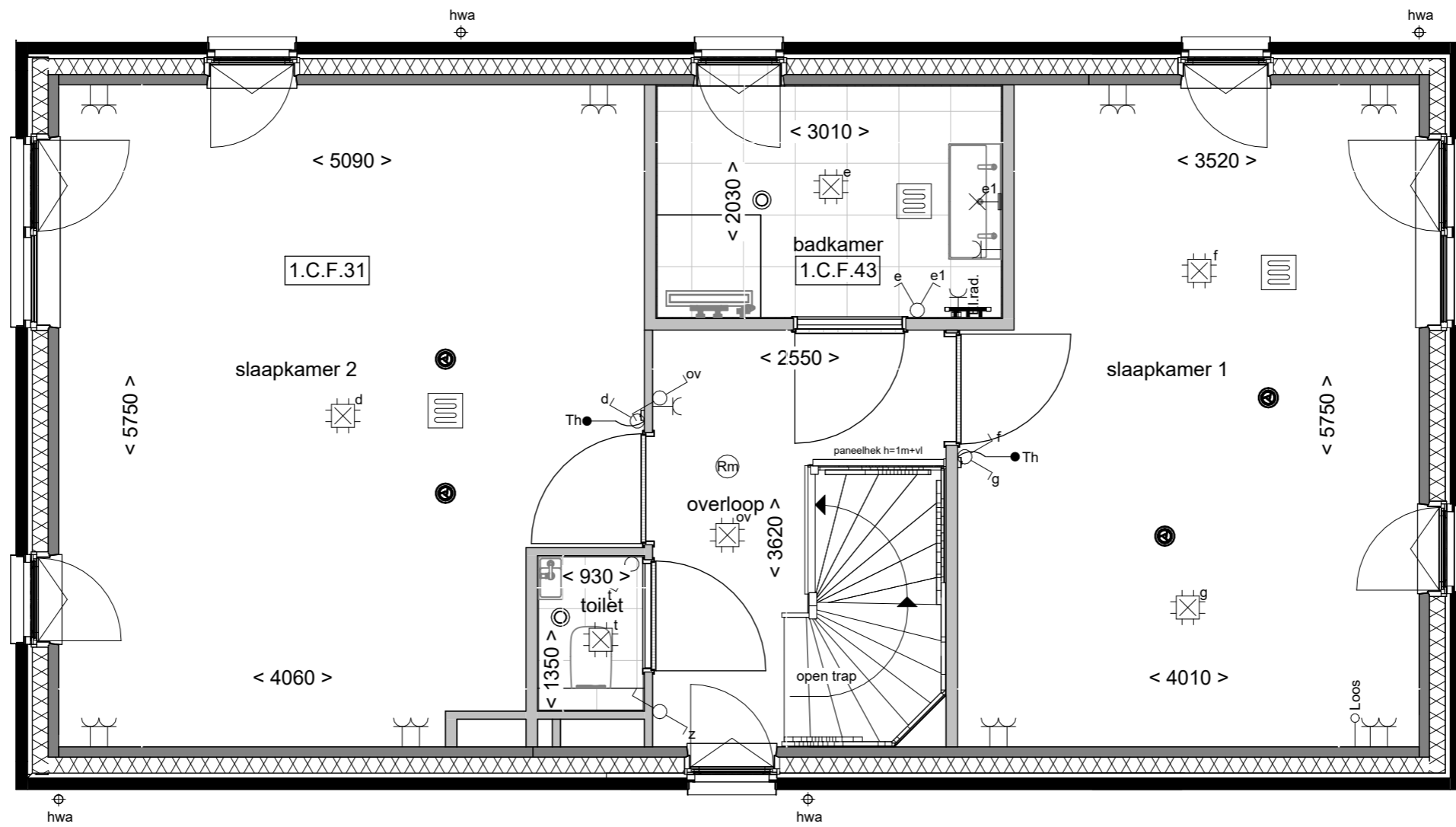

Wonen aan
de Gantel

Tekening: **Verbreden badk
samenv.slpk achter**

Woningtype: **F60+**

Bouwnummer: **8/9/14/15/18/19/20**

Optienummer: **1.C.F.31/-43**

Bladformaat: **A3**

Schaal: **1:50**

Datum: **21-04-2026**

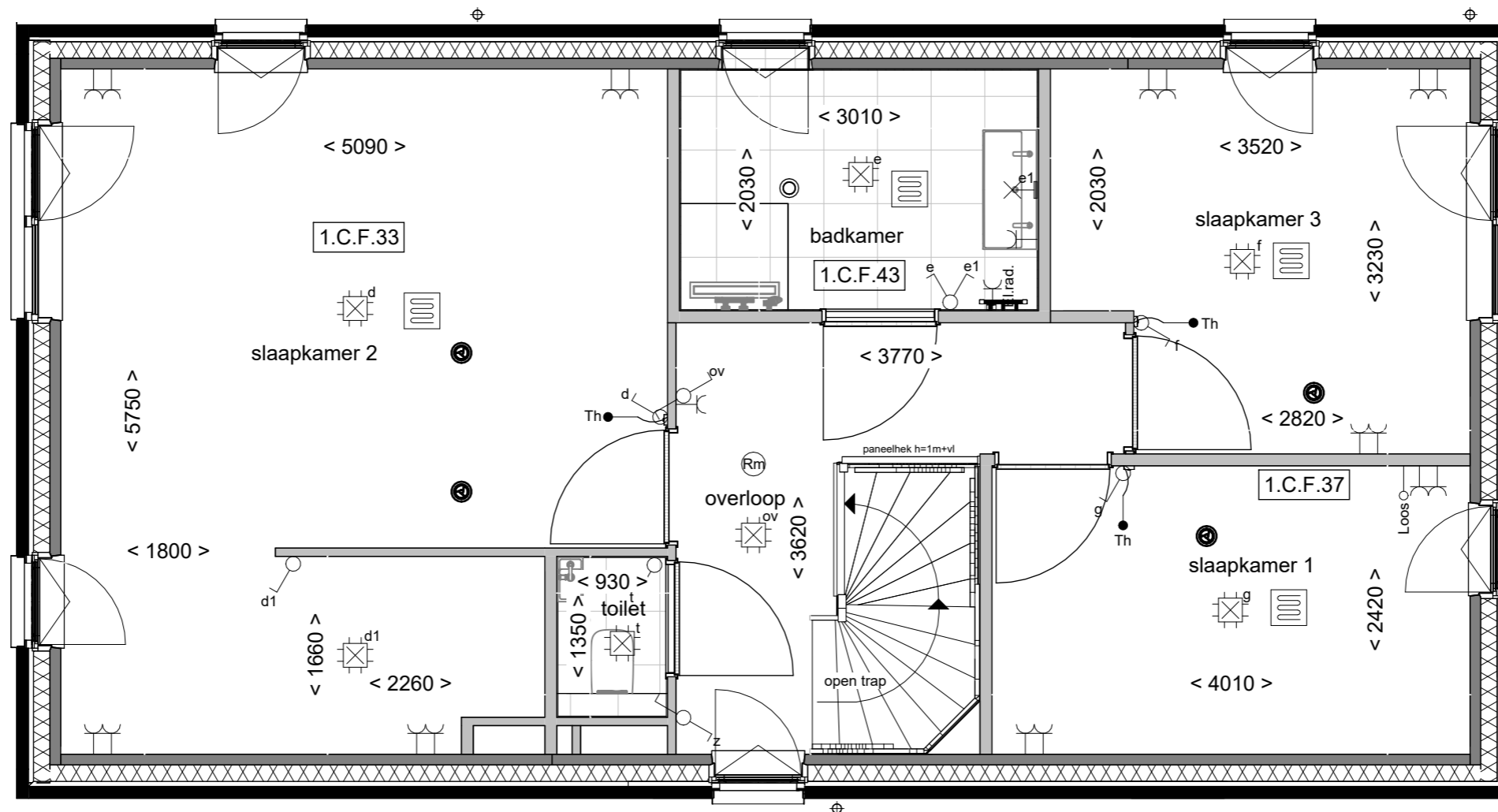

Inloopk. slpk achter
indeling 2 slpk voor

Tekening:

Woningtype: F60+

Bouwnummer: 8/9/14/15/18/19/20

Optienummer: 1.C.F.33/-37/-43

Bladformaat: A3

Schaal: 1:50

Datum: 21-04-2026

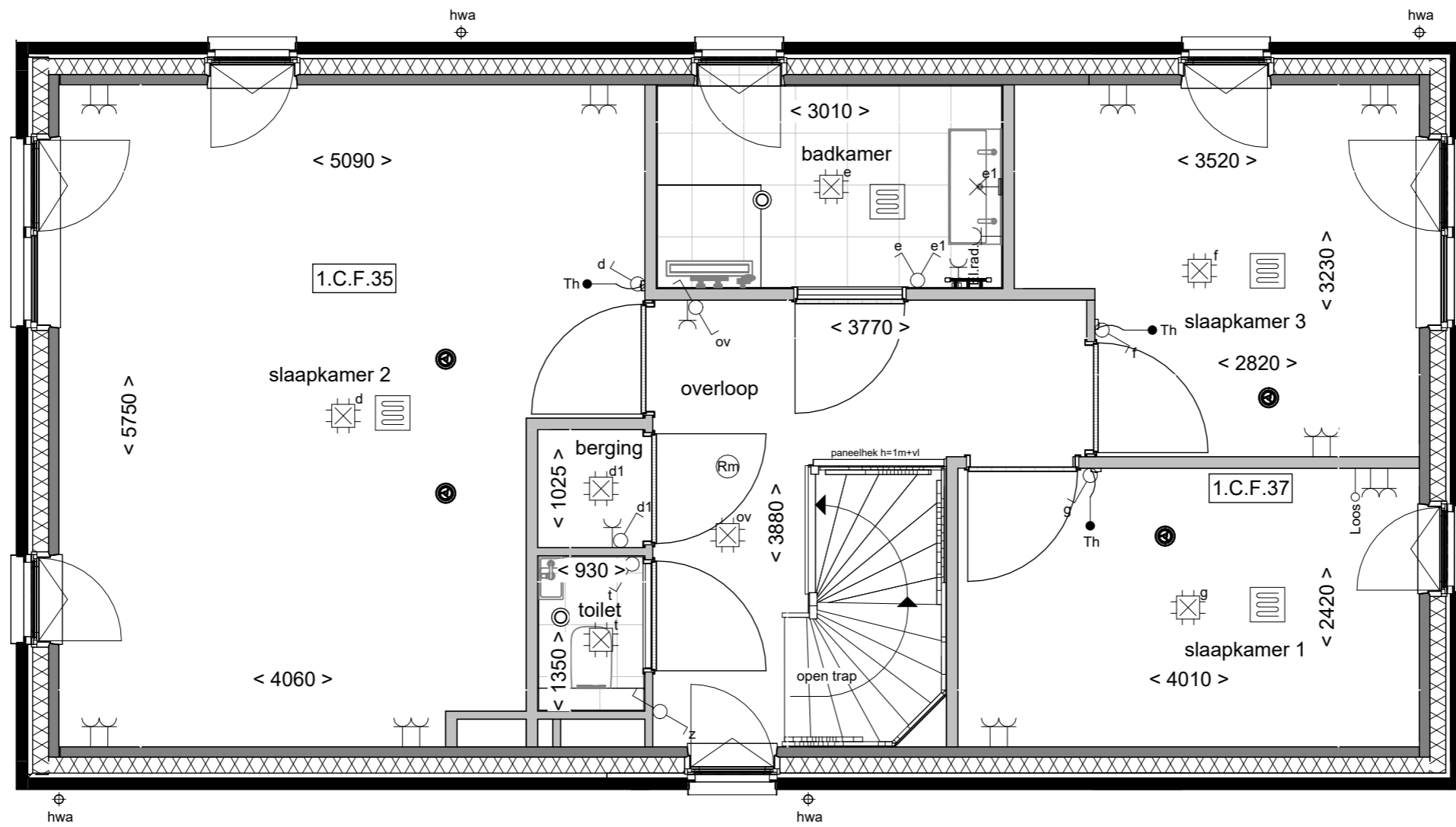

**Wonen aan
de Gantel**

Vaste kast en 2 slpk.
voor

Tekening: voor

Woningtype: F60+

Bouwnummer: 8/9/14/15/18/19/20

Optienummer: 1.C.F.35/-37

Bladformaat: A3

Schaal: 1:50

Datum: 21-04-2026

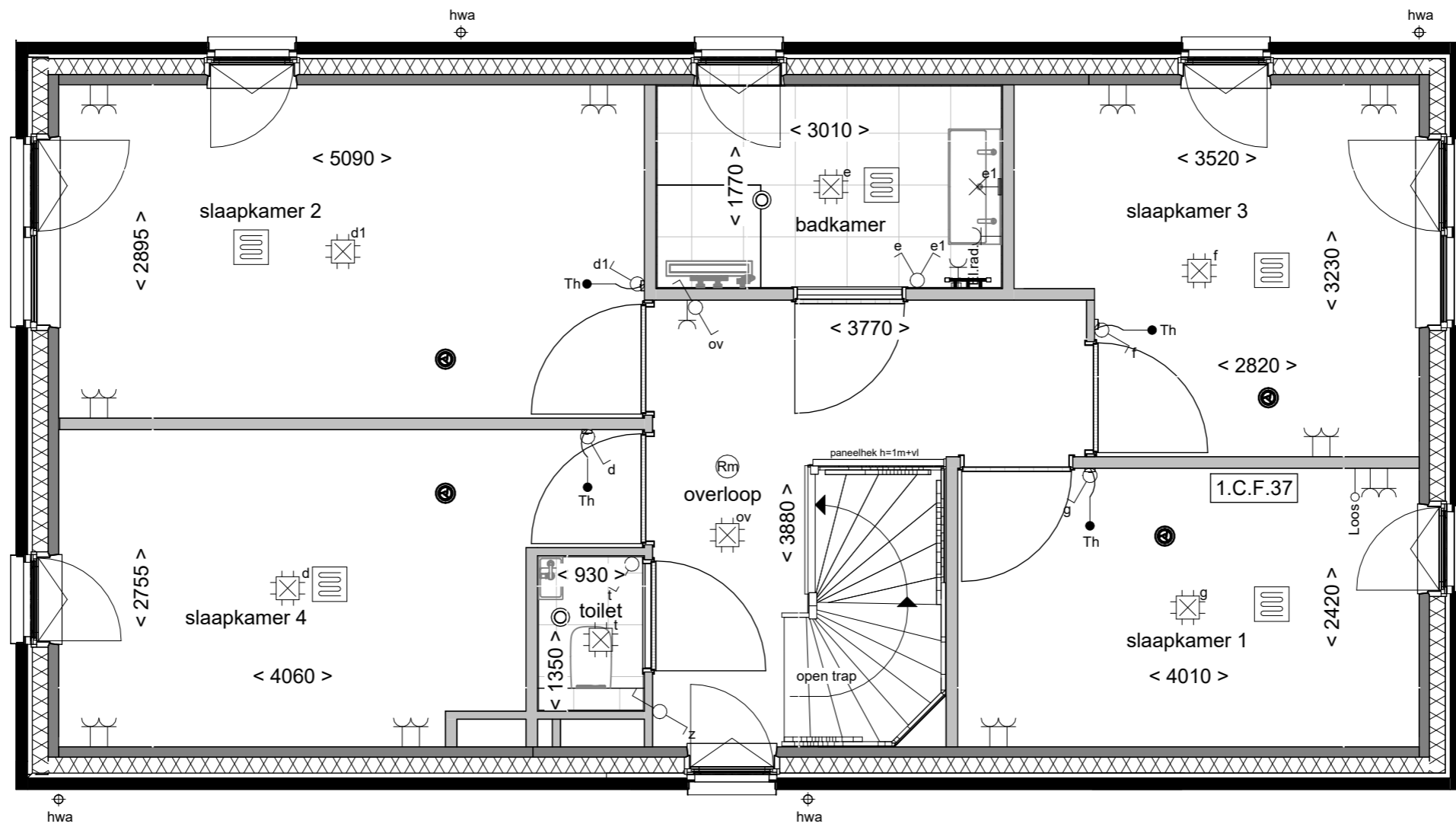

Indeling met 2
slaapkamers voor

Tekening:

Woningtype: F60+

Bouwnummer: 8/9/14/15/18/19/20

Optienummer: 1.C.F.37

Bladformaat: A3

Schaal: 1:50

Datum: 21-04-2026

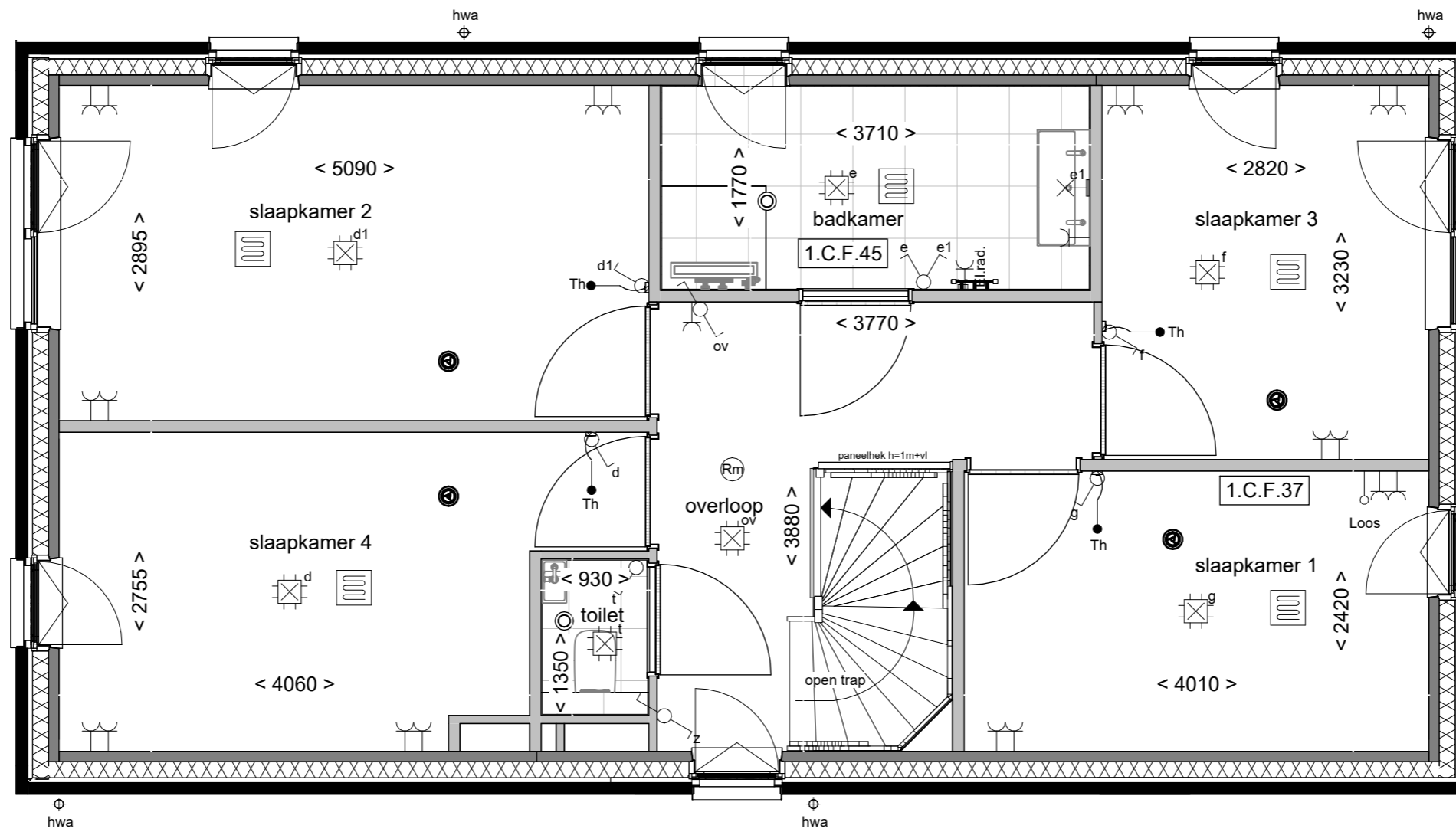

Wonen aan de Gantel

Verlengen badk. indeling 2 slpk voor

Tekening: Verlengen badk. indeling 2 slpk voor

Woningtype: F60+

Bouwnummer: 8/9/14/15/18/19/20

Optienummer: 1.C.F.37/-45

Bladformaat: A3

Schaal: 1:50

Datum: 21-04-2026

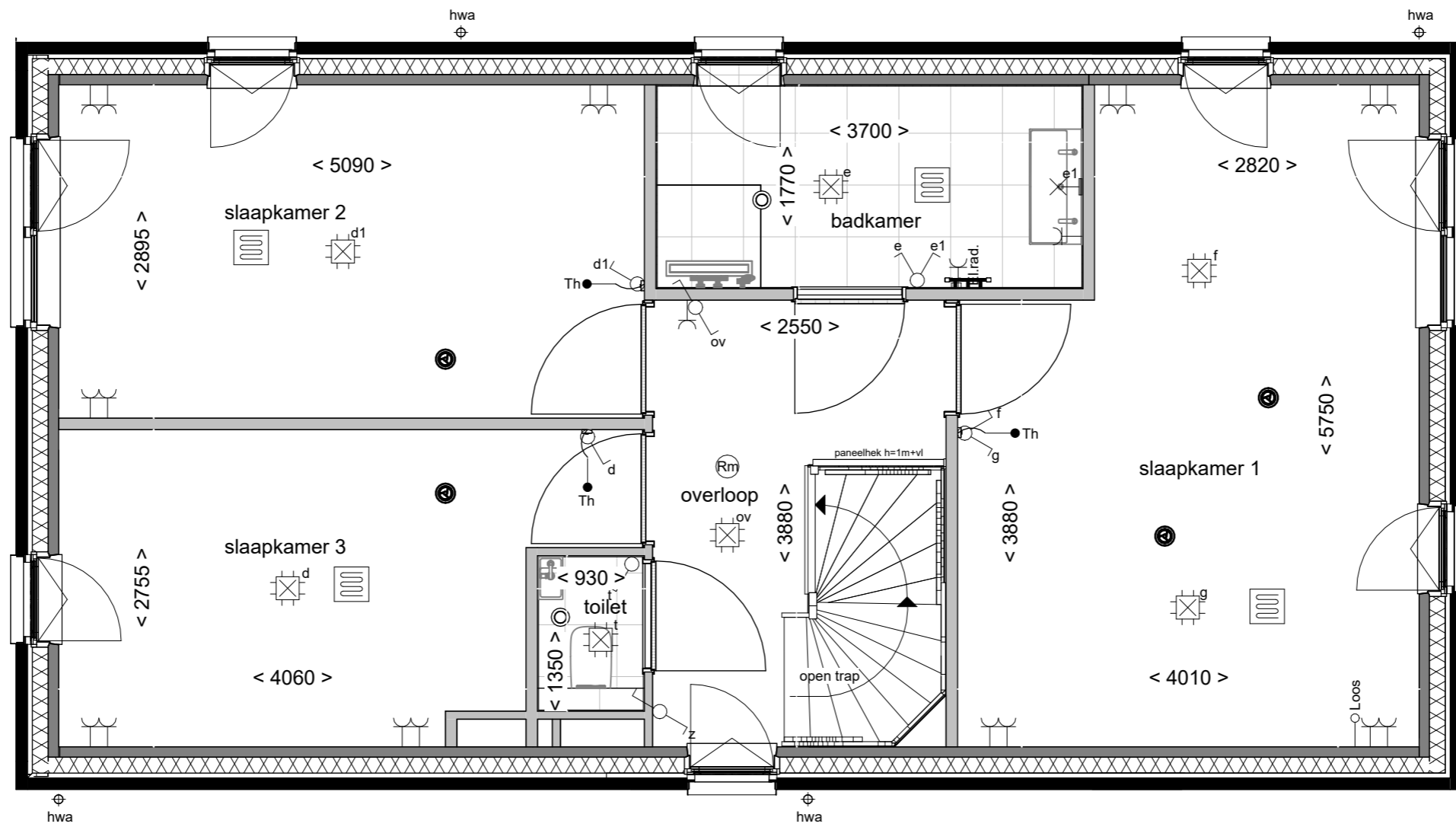

Tekening: Verlengen badkamer

Woningtype: F60+

Bouwnummer: 8/9/14/15/18/19/20

Optienummer: 1.C.F.45

Bladformaat: A3

Schaal: 1:50

Datum: 21-04-2026

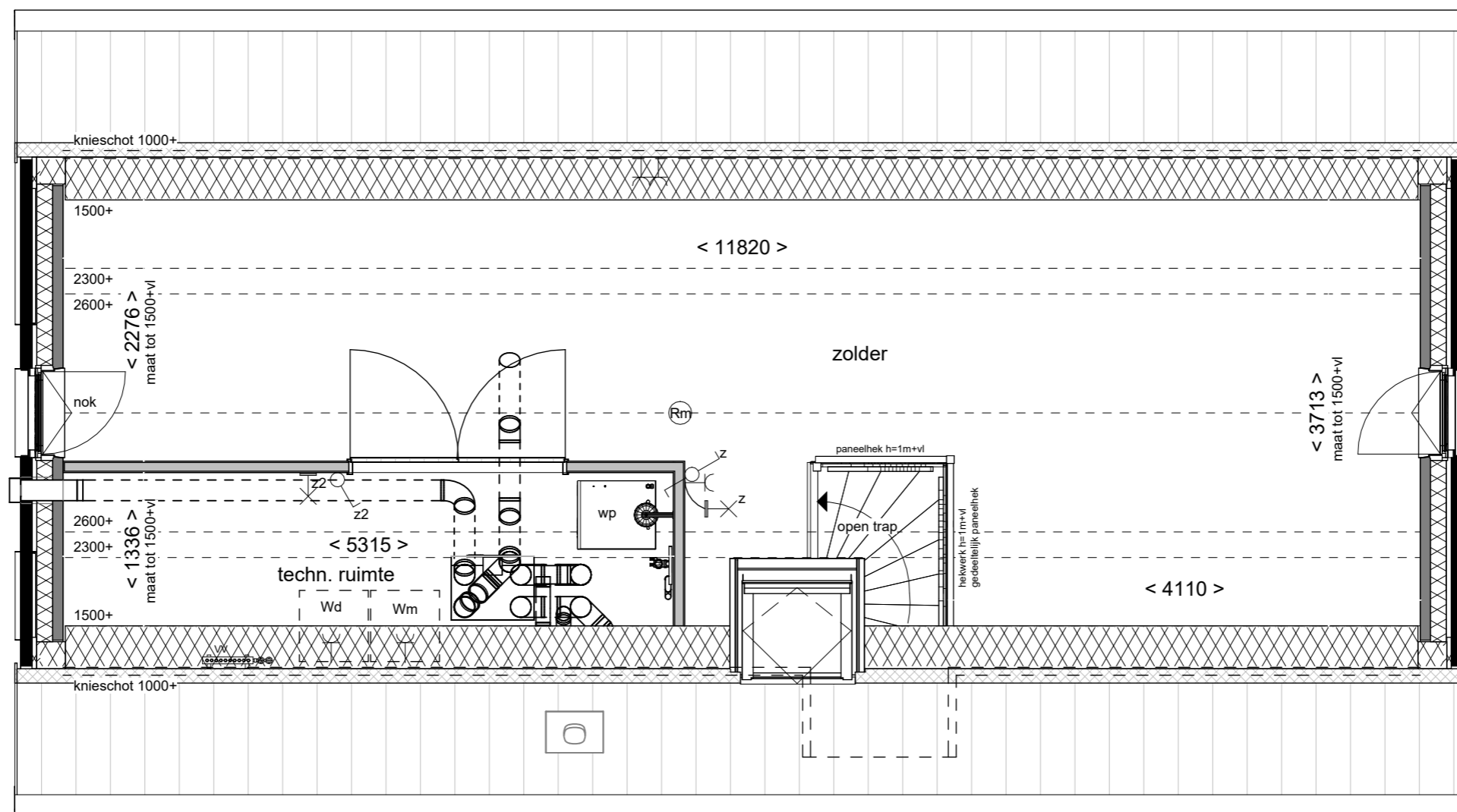

Tekening: **Indeling met techniekkast**

Woningtype: **F60+**

Bouwnummer: **8/9/14/15/18/19/20**

Optienummer: **1.C.F.70**

Bladformaat: **A3**

Schaal: **1:50**

Datum: **21-04-2026**

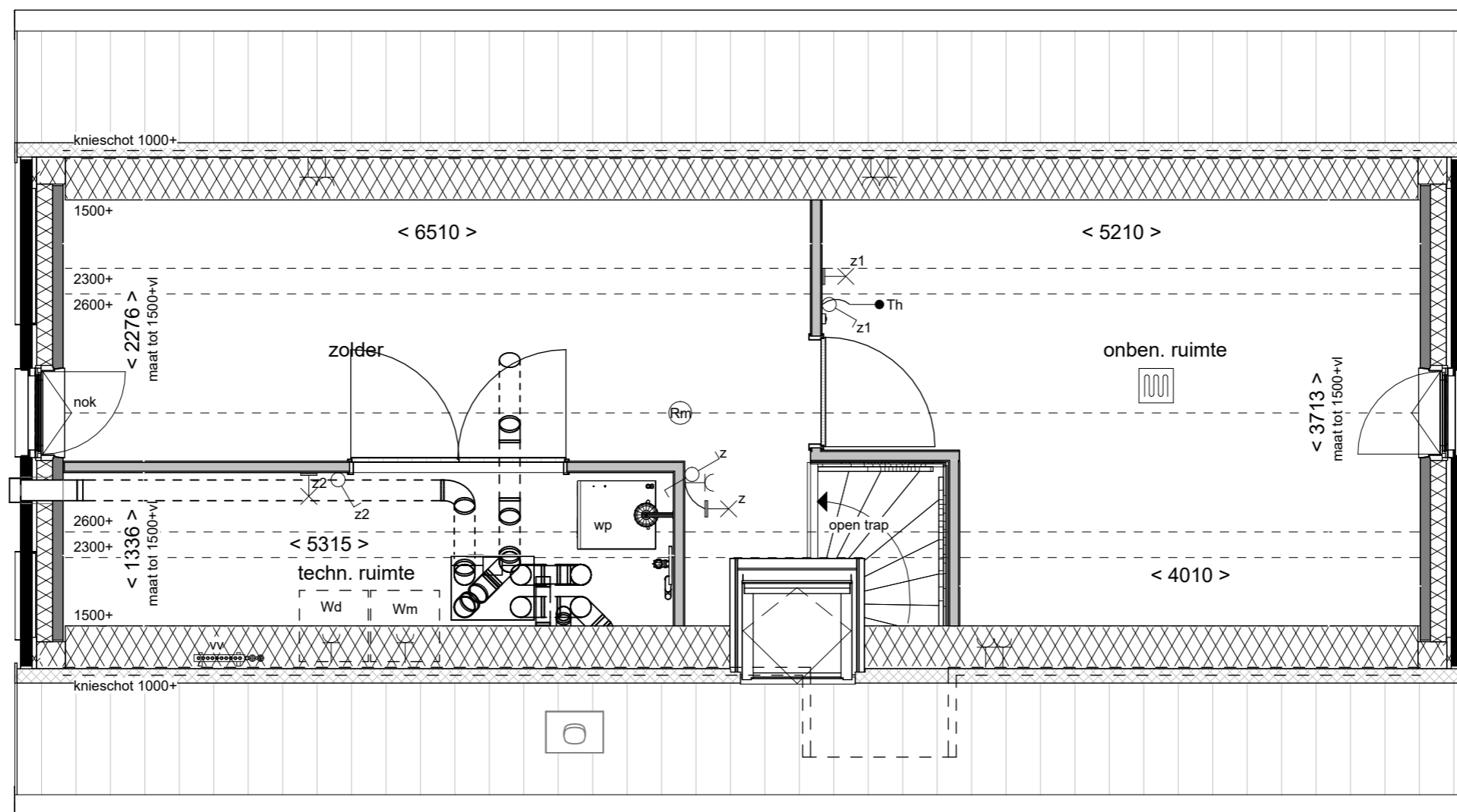

**Wonen aan
de Gantel**

Tekening: **Indeling met één onbenoemde ruimte**

Woningtype: **F60+**

Bouwnummer: **8/9/14/15/18/19/20**

Optienummer: **1.C.F.72**

Bladformaat: **A3**

Schaal: **1:50**

Datum: **21-04-2026**

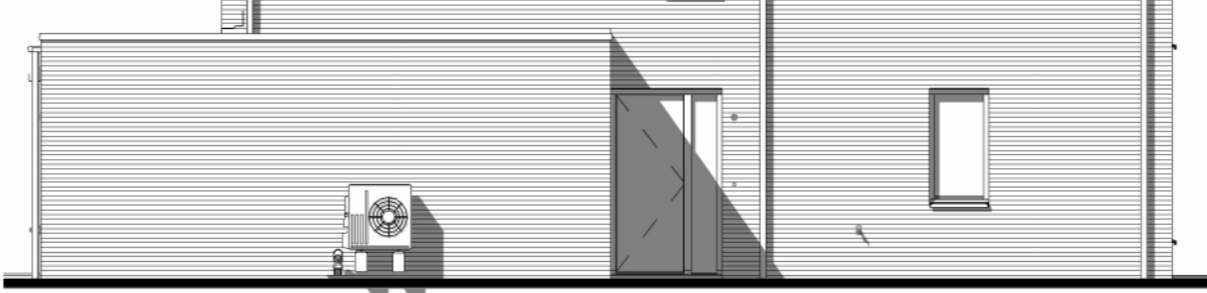
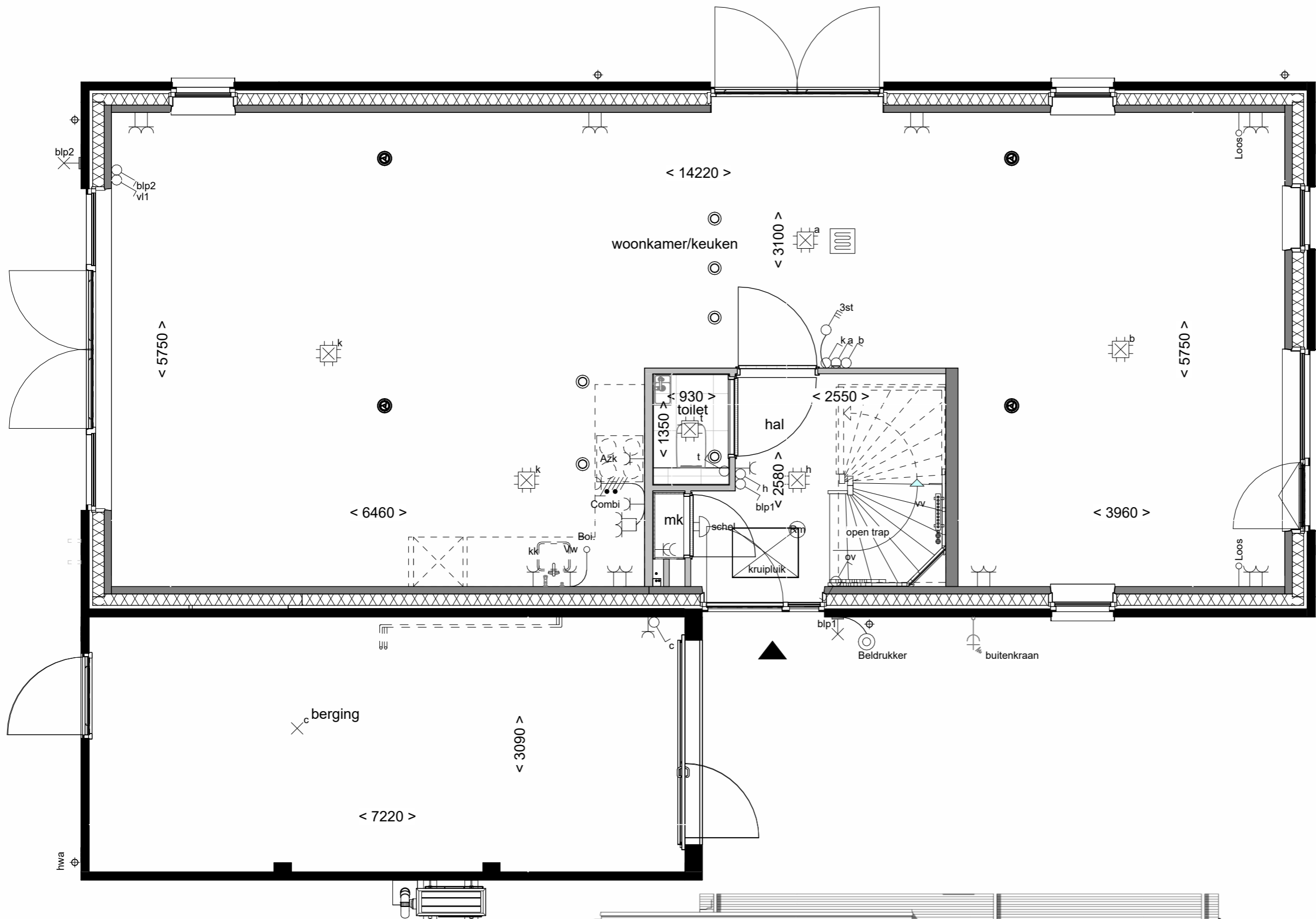

Linkerzijgevel schaal 1:100



vorstvrij buitenkraan
naast voordeur

Tekening:	
Woningtype:	F60+
Bouwnummer:	8/9/14/15/18/19/20
Optienummer:	2.K.0.40
Bladformaat:	A3
Schaal:	1:50 / 1:100
Datum:	21-04-2026

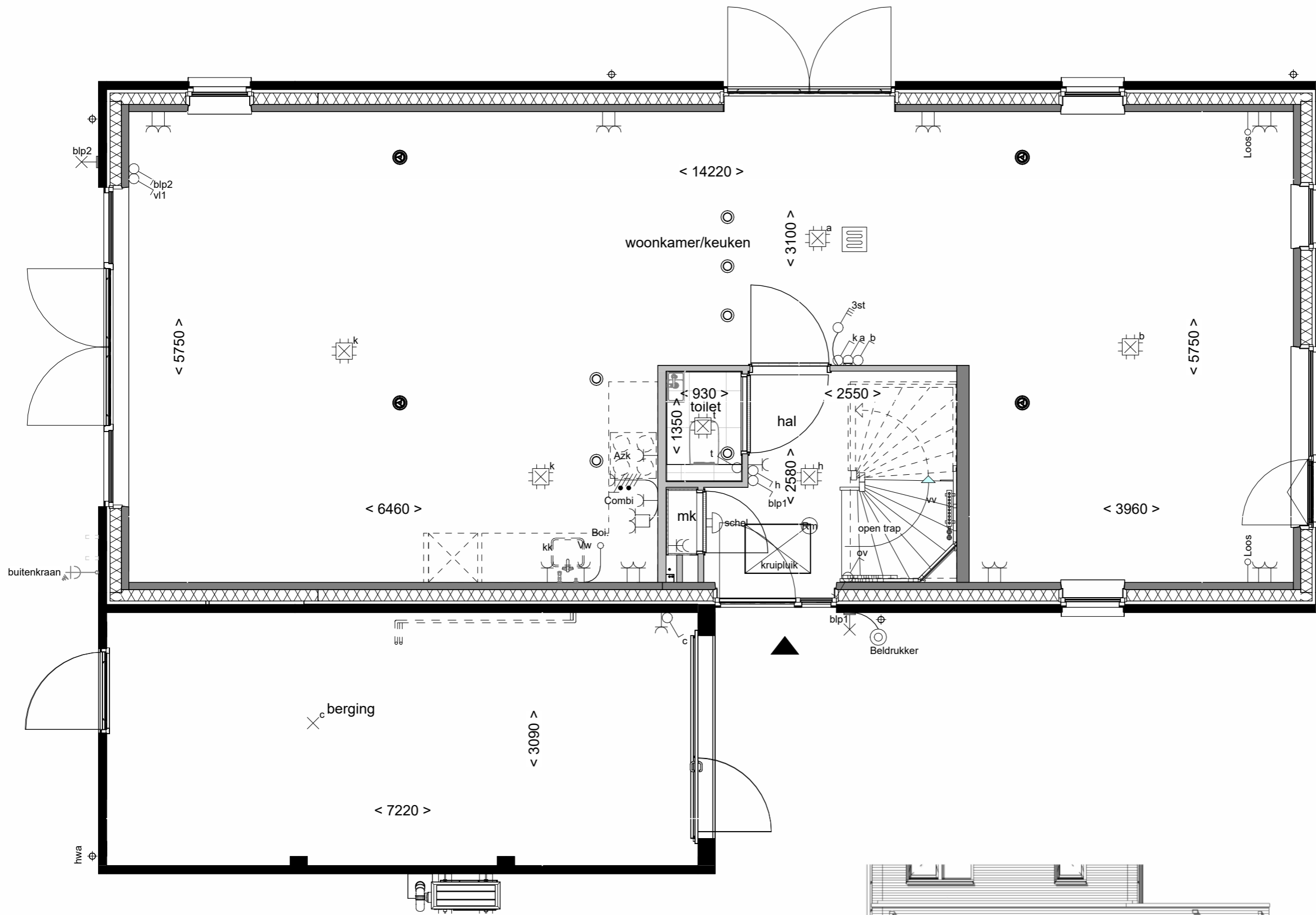

Achtergevel schaal 1:100



vorstvrij buitenkraan
achter

Tekening:	vorstvrij buitenkraan achter
Woningtype:	F60+
Bouwnummer:	8/9/14/15/18/19
Optienummer:	2.K.0.44
Bladformaat:	A3
Schaal:	1:50 / 1:100
Datum:	21-04-2026

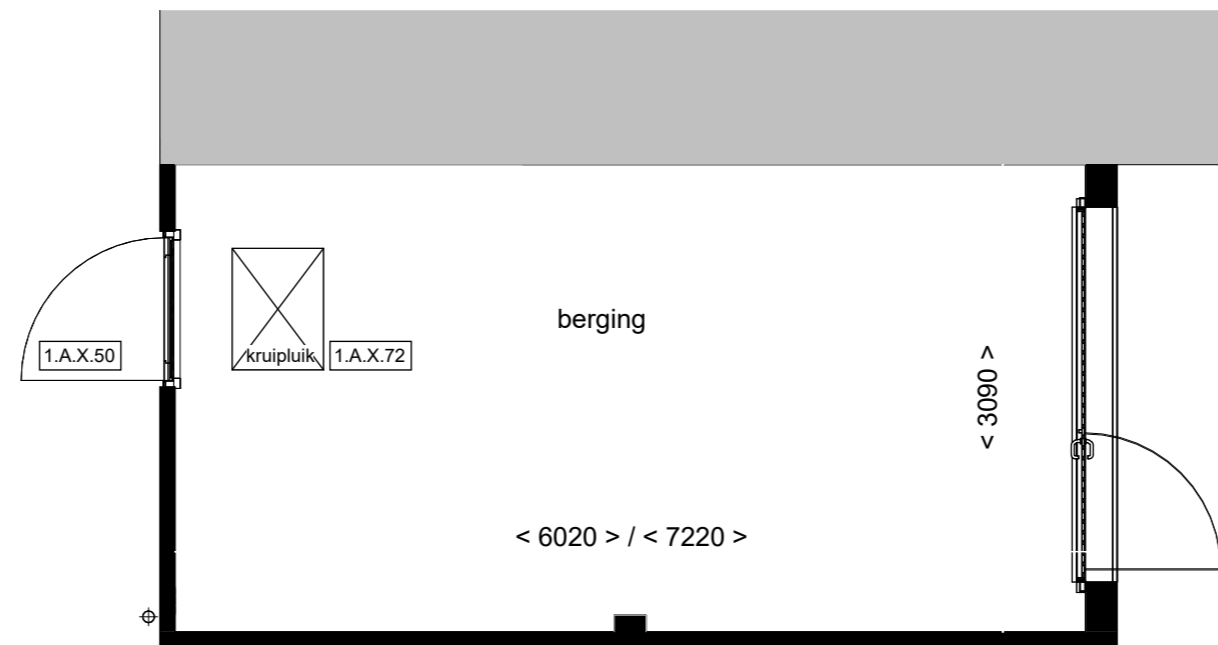

Kruipluik in de berging

Tekening: **Kruipluik in de berging**

Woningtype: **E60/F60/F60+/F60D**

Bouwnummer: **1 t/m 20**

Optienummer: **1.A.X.50 / 1.A.X.72**

Bladformaat: **A3**

Schaal: **1 : 50**

Datum: **21-04-2026**

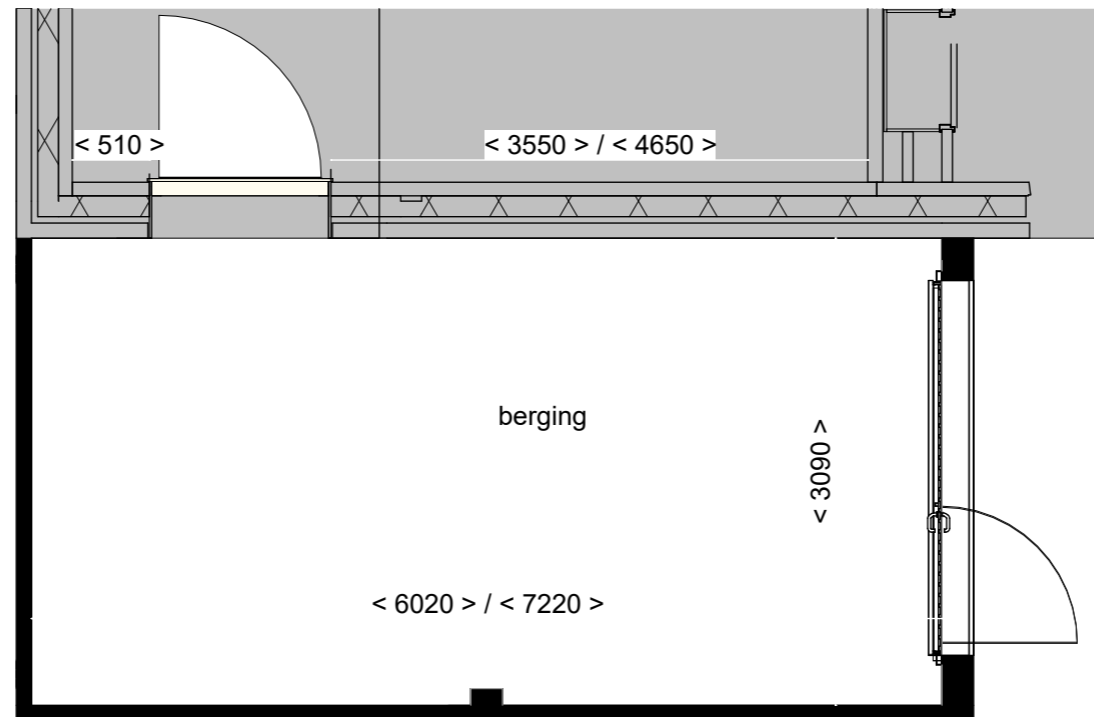

Tekening: Buitendeur tussen woning en berging

Woningtype: E60/F60/F60+

Bouwnummer: 1 t/m 19

Optienummer: 1.A.X.74 B

Bladformaat: A3

Schaal: 1 : 50

Datum: 21-04-2026

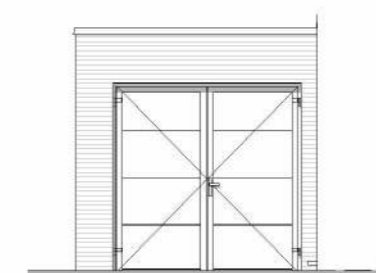
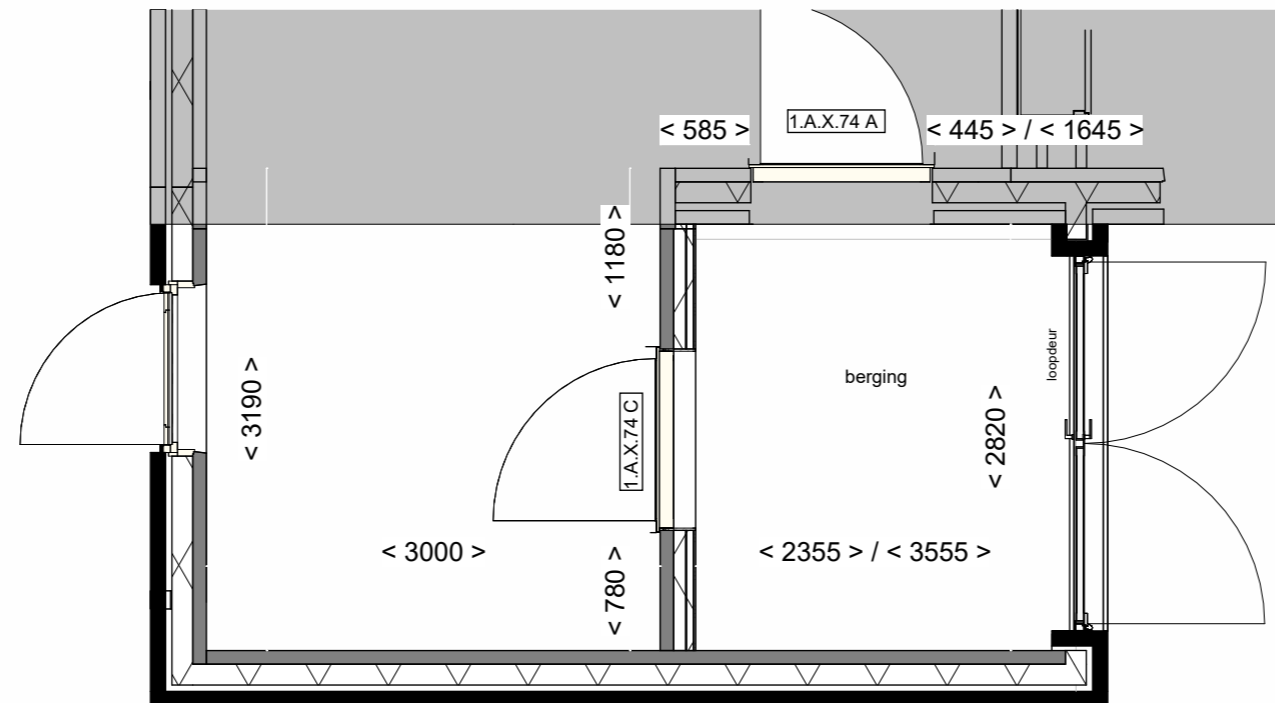

Voorgevel schaal 1:100



Buitendeur tussen
woning en berging

Tekening:

Woningtype: E60/F60/F60+

Bouwnummer: 1 t/m 19

Optienummer: 1.A.X.74 C

Bladformaat: A3

Schaal: 1:50

Datum: 21-04-2026

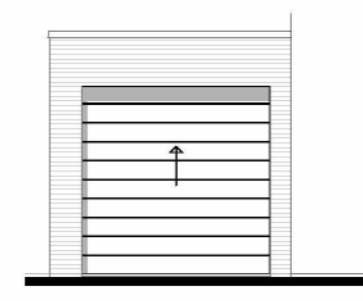
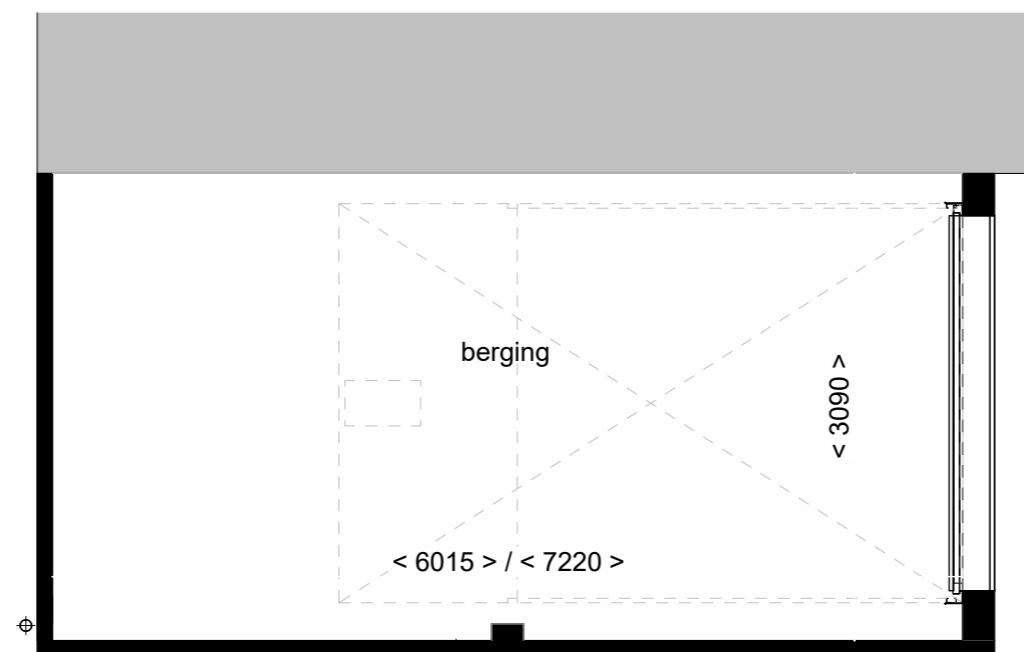

Voorgevel schaal 1:100



**Wonen aan
de Gantel**

Sectionaaldeur ipv
kanteldeur

Tekening:

Woningtype: E60/F60/F60+/F60D

Bouwnummer: 1 t/m 20

Optienummer: 1.A.X.80

Bladformaat: A3

Schaal: 1:50

Datum: 21-04-2026

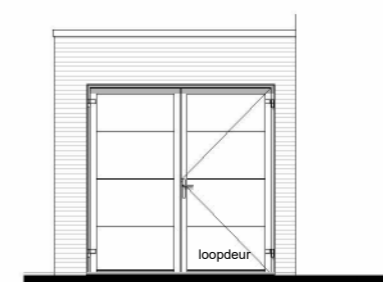
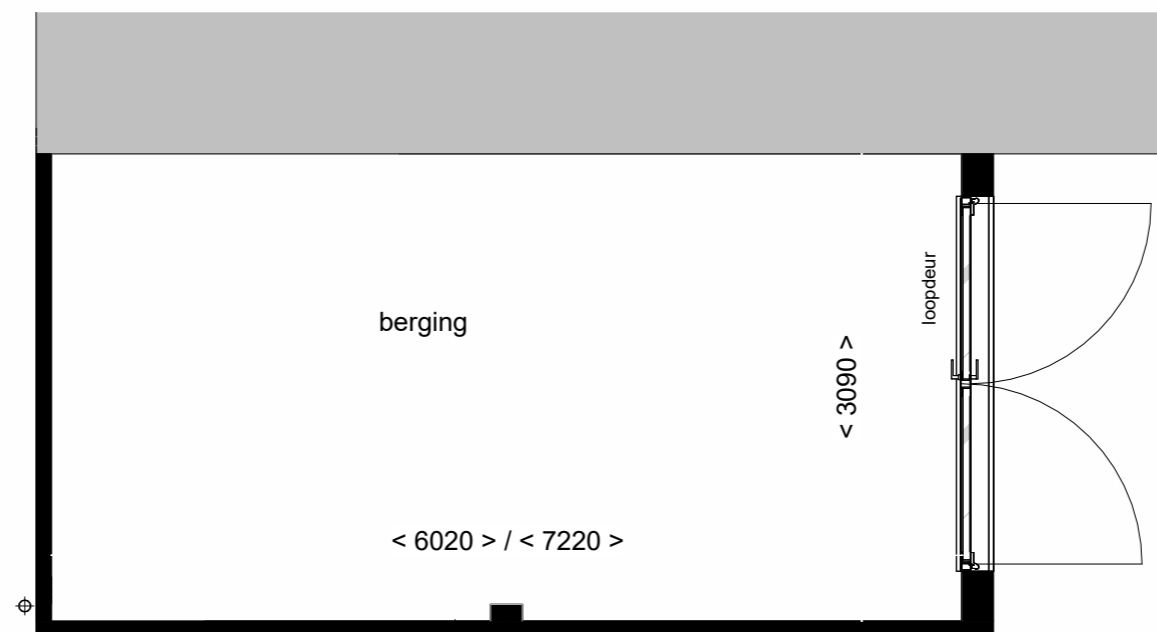

Voorgevel schaal 1:100



**Wonen aan
de Gantel**

Dubbele
openslaande deuren

Tekening: **Dubbele
openslaande deuren**

Woningtype: **E60/F60/F60+/F60D**

Bouwnummer: **1 t/m 20**

Optienummer: **1.A.X.84**

Bladformaat: **A3**

Schaal: **1:50**

Datum: **21-04-2026**

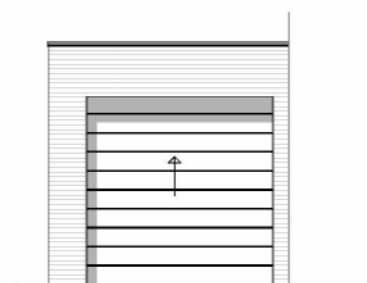
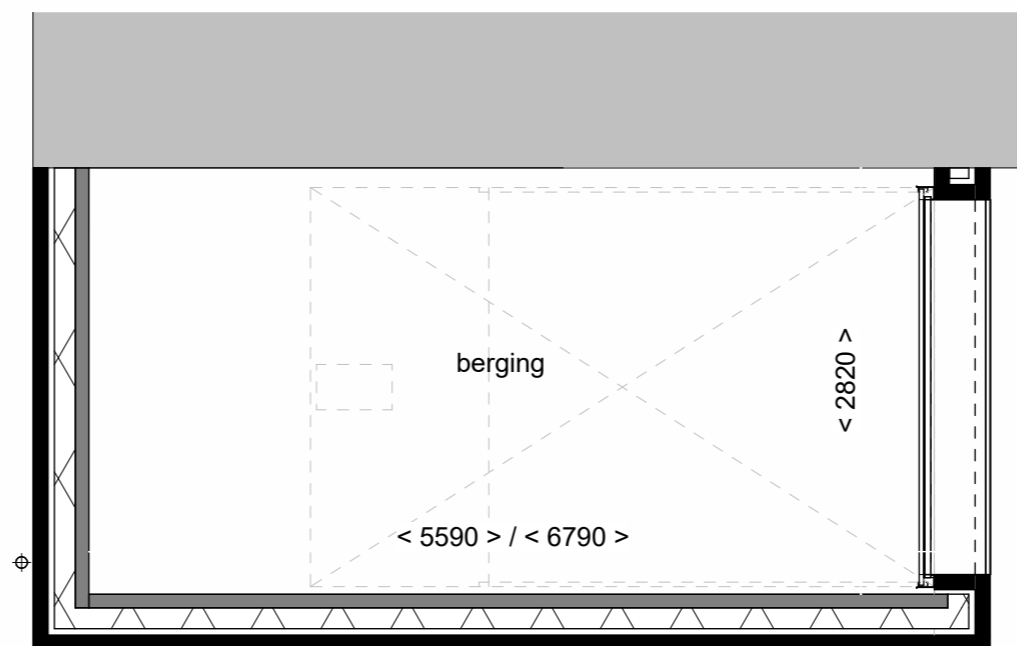

Voorgevel schaal 1:100



Achtergevel schaal 1:100



**Wonen aan
de Gantel**

Tekening: **Isoleren berging**

Woningtype: **E60/F60/F60+/F60D**

Bouwnummer: **01 t/m 20**

Optienummer: **1.A.X.86**

Bladformaat: **A3**

Schaal: **1:50**

Datum: **21-04-2026**

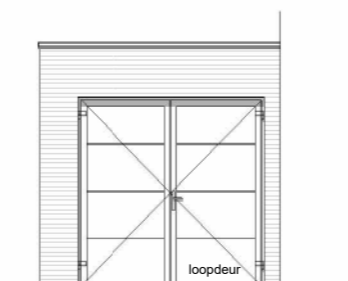
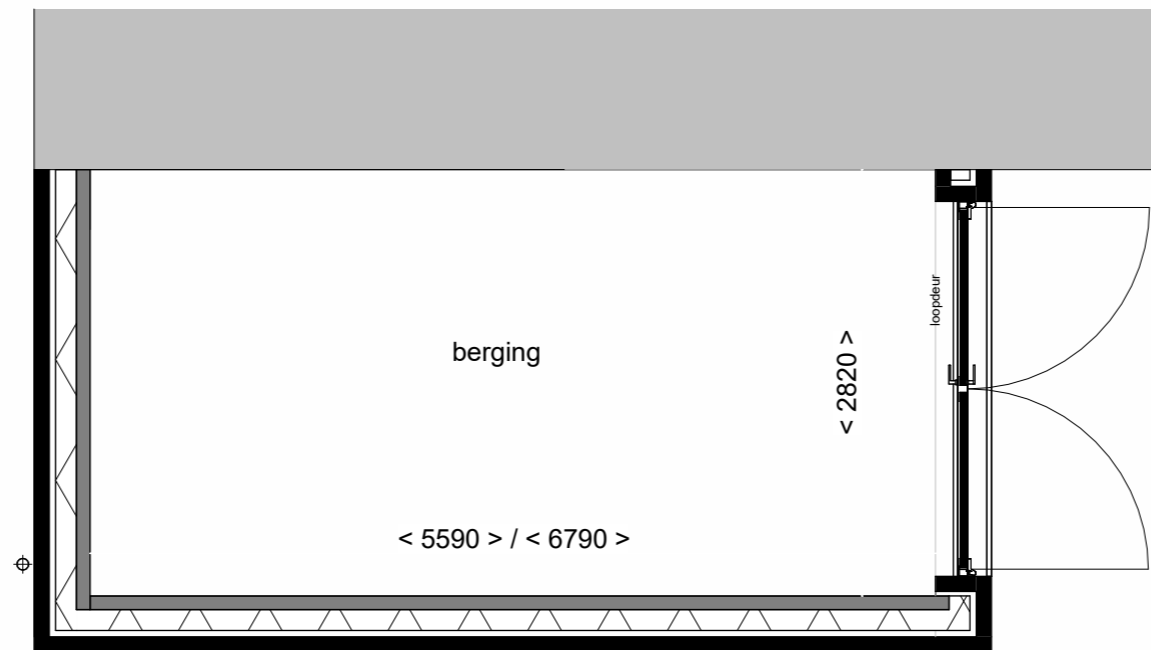

Voorgevel schaal 1:100



Achtergevel schaal 1:100



**Wonen aan
de Gantel**

Dubbele deuren,
isoleren

Tekening:

Woningtype: E60/F60/F60+/F60D

Bouwnummer: 1 t/m 20

Optienummer: 1.A.X.94

Bladformaat: A3

Schaal: 1:50

Datum: 21-04-2026