

Renvooi

-  - entree woongebouw
-  - erfgrans
-  - parkeervak eigen terrein
-  - parkeervak openbaar
-  - houten vlonder
-  - pergola
-  - haag laag
-  - haag hoog
-  - water
-  - openbaar groen
-  - wandelpad houtsnippers
-  - voetpad
-  - inrit
-  - straat
-  - talud
-  - boom, positie in overleg met koper
-  - indicatie positie riolering
-  - zone erfdienstbaarheid
-  - klinkerbestrating

parkeerplekken en posities bomen indicatief



Tekening: **Situatie totaal**

Woningtype: **E60,E60D,F60,F60+**

Bouwnummer: **1 t/m 31**

Bladnummer: **VT-S-00**

Bladformaat: **A3**

Schaal: **1:750**

Datum: **21-04-2026**



Renvooi

- entree woongebouw
- erfgrans
- parkeervak eigen terrein
- parkeervak openbaar
- houten vlonder
- pergola
- haag laag
- haag hoog
- water
- openbaar groen
- wandelpad houtsnippers
- voetpad
- inrit
- straat
- talud
- boom, positie in overleg met koper
- indicatie positie riolering
- zone erfdienstbaarheid
- klinkerbestrating

parkeerplekken en posities bomen indicatief



Tekening: **Situatie bnr. 6-8**

Woningtype: **E60, E60D, F60+**

Bouwnummer: **6, 7, 8**

Bladnummer: **VT-S-02**

Bladformaat: **A3**









Schaal: **1:200**

Datum: **21-04-2026**

Renvooi materialen

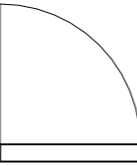
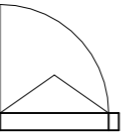
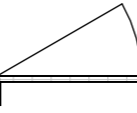
	dakpan antracietgrijs
	metselwerk kleur grijswit gesinterd code A: EN1166 WF WS
	metselwerk kleur bruin nuance code B: HM1106 WF WS
	metselwerk kleur bruin caramel code C: EN1165 WF WS
	gevelbetimmering vuren vergrijsd

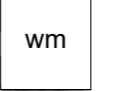
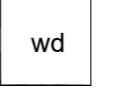
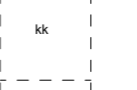
Renvooi bouwkundig

	entree woning
	metselwerk
	isolatie
	dragende wand
	niet dragende binnenwand
	buitendeur
	draairaam
	binnendeurkozijn (met bovenlicht)
	kruipluik
	opstelplaats wasmachine
	opstelplaats wasdroger
	opstelplaats koelkast
	principe opstelling keukenblok
	onbenoemde ruimte volgens krijtstreepmethode

Renvooi installaties

	aansluitpunt licht, wand
	centraaldoos met lichtpunt
	armatuur aan de wand
	rookmelder
	aansluitpunt niet bedraad / loos
	aansluitpunt bedraad data, niet afgemonteerd
	beldrukker
	schel
	schakelaar, 1-polig
	werkschakelaar tbv PV-panelen
	driestandenschakelaar tbv wtw
	schakelaar, wissel
	schakelaar, serie
	pulsschakelaar tbv warmteterugwinunit
	wandcontactdoos 1-voudig met beschermingscontact
	wandcontactdoos 2-voudig met beschermingscontact
	thermostaatleiding, bedraad
	wandcontactdoos tbv warmteterugwinunit
	wtw mechanische ventilatie-unit incl. warmteterugwinunit
	wp warmtepomp
	inblaasventiel mechanische ventilatie
	afzuigventiel mechanische ventilatie
	vv verdeler vloerverwarming
	ruimte vzv vloerverwarming
	rad elektrische radiator
	kanalen in het zicht
	doucheput
	lijngoot douche
	buitenkraan

Disclaimer

De op deze tekeningen aangegeven maten zijn circa maten in millimeters en tussen de wanden / vloeren gemeten, waarbij geen rekening is gehouden met enige wandafwerking, plinten, aftimmering, etc. In verband met de nauwkeurige uitwerking van details, constructie, maatvoering, materialen e.d. kunnen er kleine afwijkingen ontstaan ten opzichte van de nu vermelde gegevens. Deze geringe afwijkingen geven geen aanleiding tot verrekening. Aan de op deze tekening aangegeven maten kunnen derhalve geen rechten worden ontleend. De op deze tekeningen aangegeven maatvoering is niet geschikt voor opdrachten aan derden door koper(s). De posities van aansluitingen en installatie onderdelen zijn indicatief op tekening aangegeven. De exacte aantallen en posities zullen na berekening in het werk door de installateurs worden bepaald en kunnen afwijken van deze tekening.



Tekening:	Renvooi
Woningtype:	E60 / F60 / F60+
Bouwnummer:	1 t/m 31
Bladnummer:	VT-0-00c
Bladformaat:	A3
Schaal:	1 : 50
Datum:	21-04-2026



Voorgevel

Type: F60+s
bnr: 8

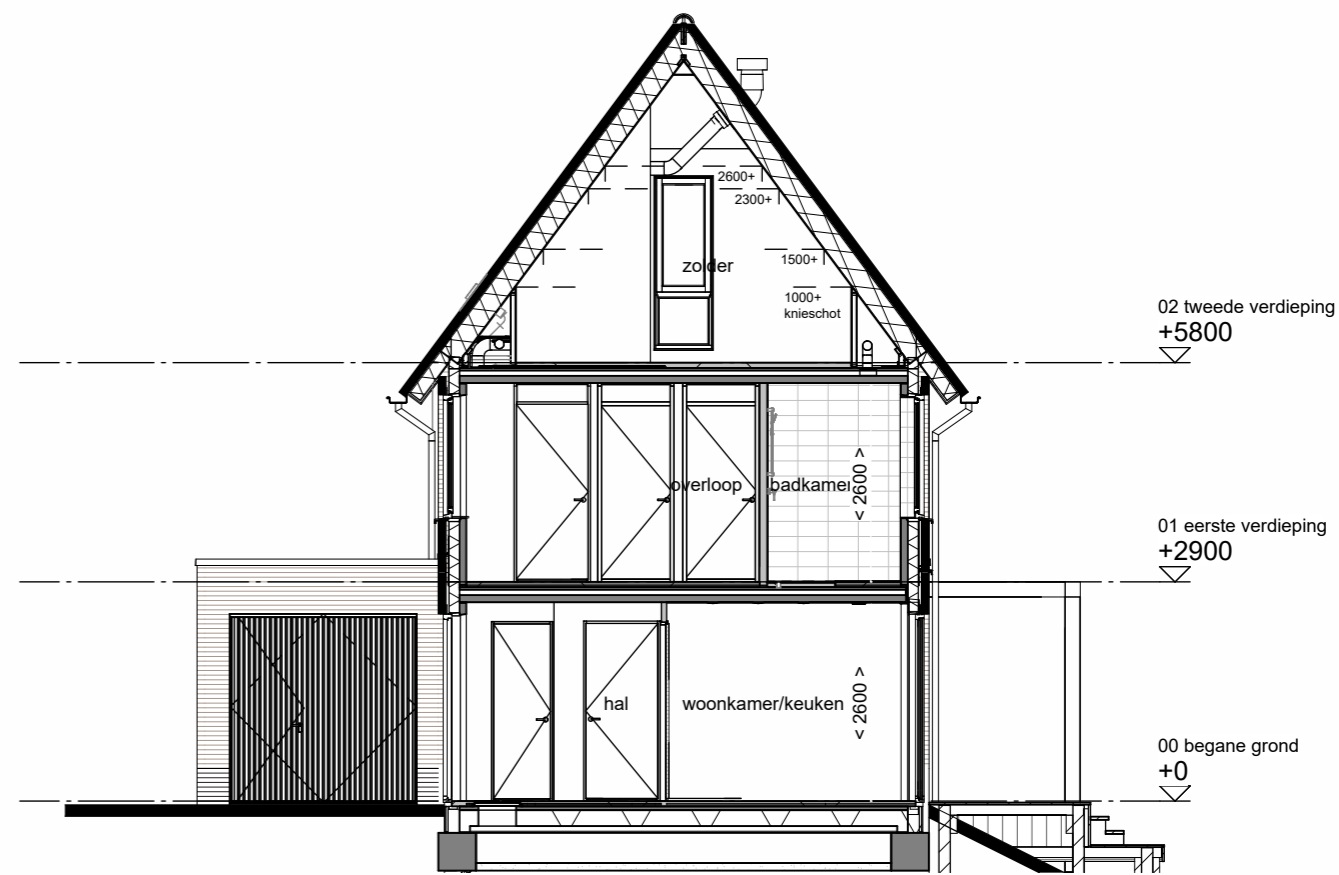

Doorsnede



Achtergevel

Type: F60+s
bnr: 8



Wonen aan
de Gantel

Tekening: Gevel/Drsn Blok 5

Woningtype: F60+s

Bouwnummer: 8

Bladnummer: VT-05-00a

Bladformaat: A3

Schaal: 1 : 100

Datum: 21-04-2026



Linker zijgevel

Type: F60+s
bnr: 8



Rechter zijgevel

Type: F60+s
bnr: 8



Tekening: Zijgevels blok 5

Woningtype: F60+s

Bouwnummer: 8

Bladnummer: VT-05-00b

Bladformaat: A3

Schaal: 1 : 100

Datum: 21-04-2026

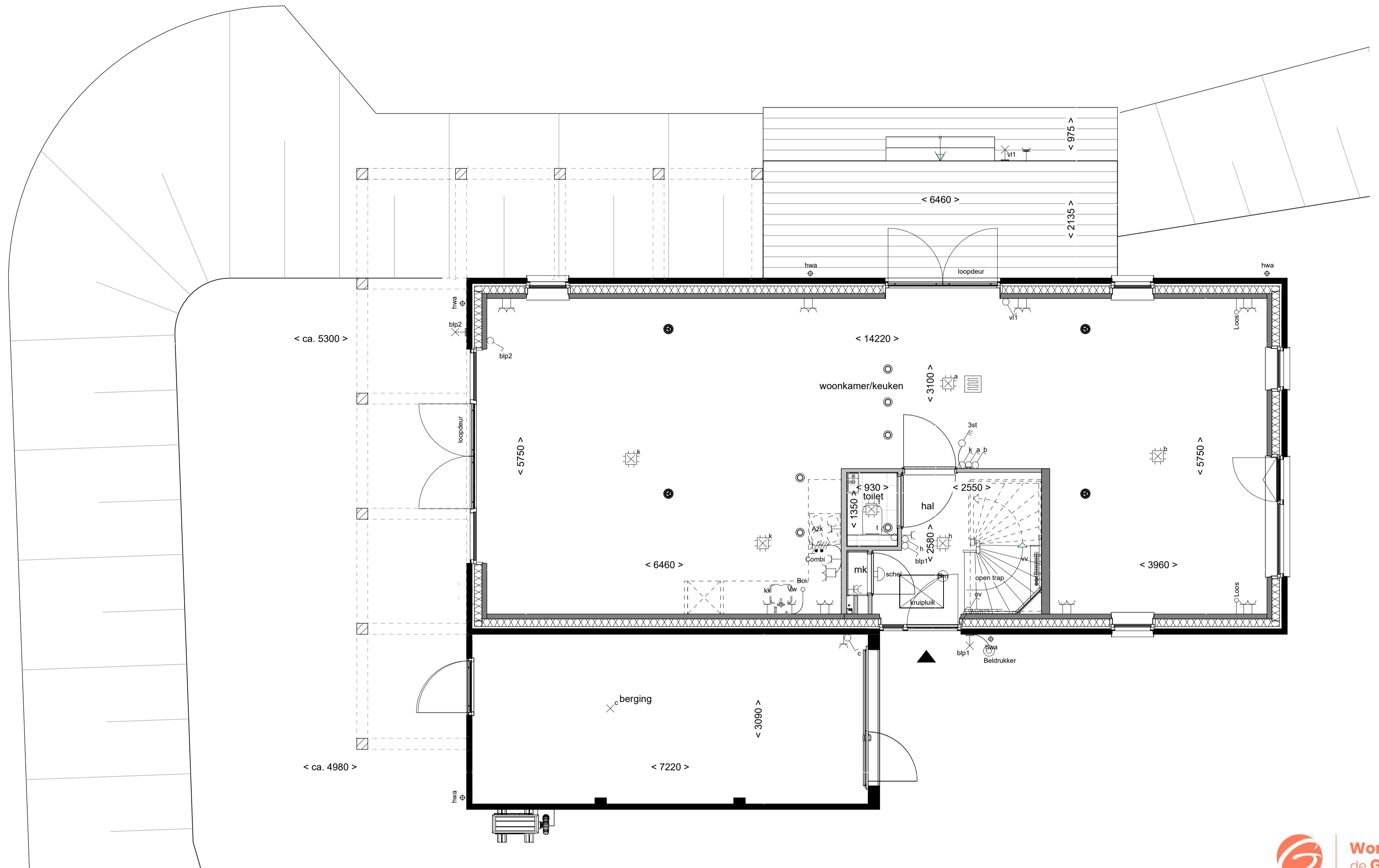

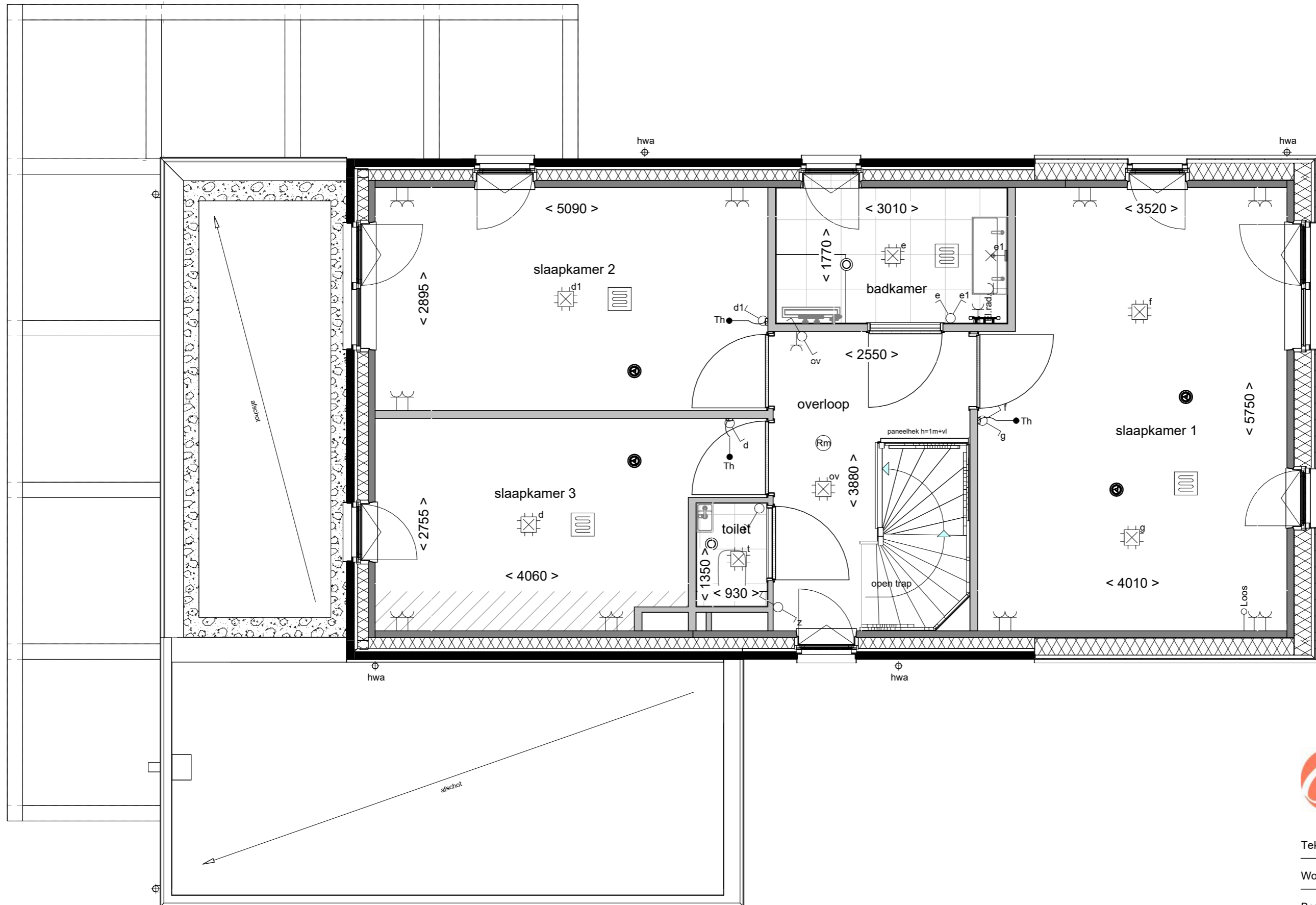

Tekening: **Eerste verdieping**

Woningtype: **F60+s**

Bouwnummer: **8**

Bladnummer: **VT-05-08b**

Bladformaat: **A3**

Schaal: **1 : 50**

Datum: **21-04-2026**

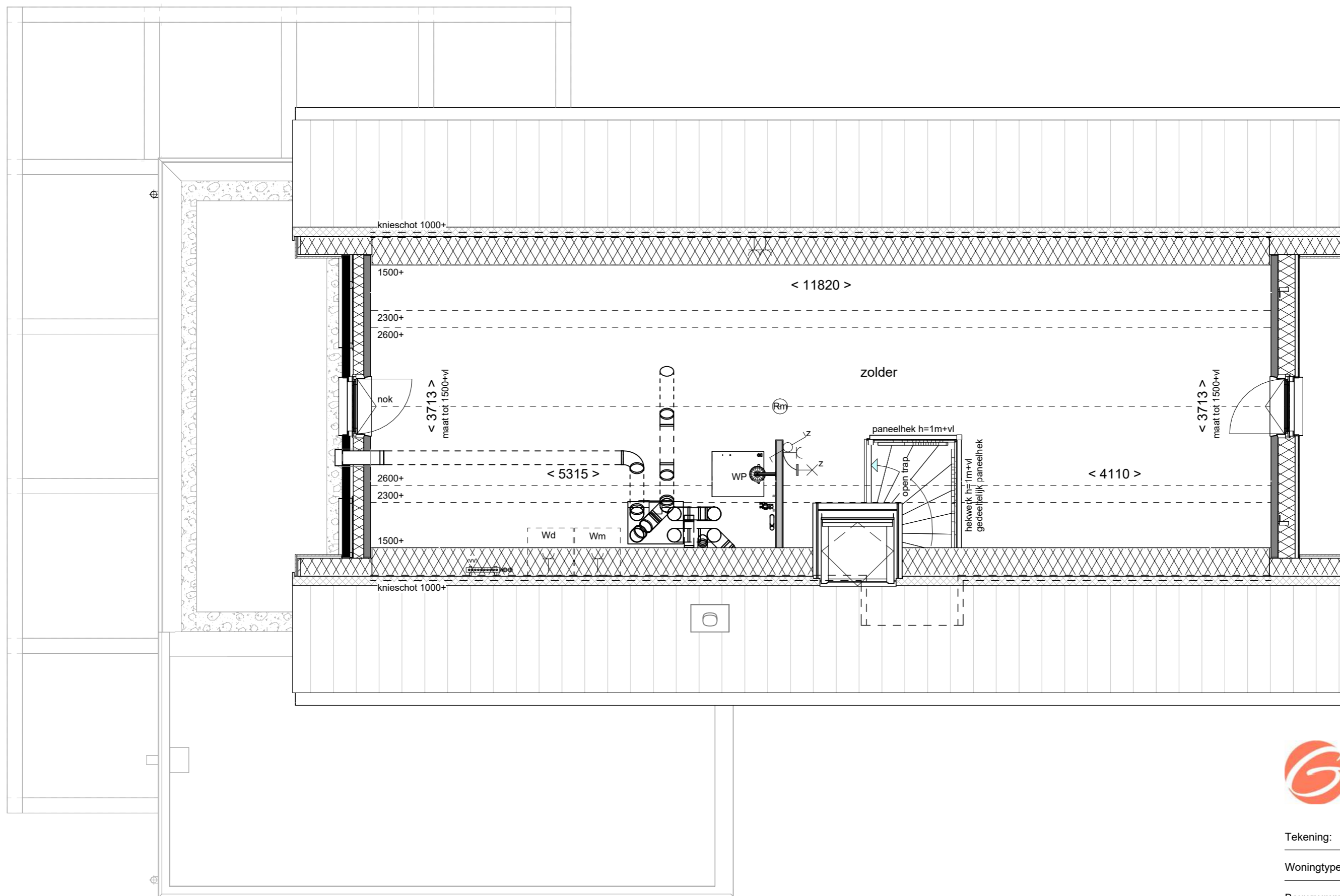

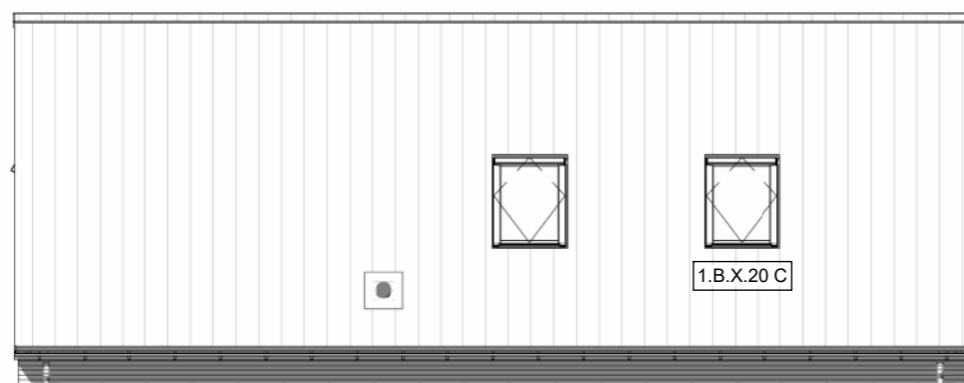
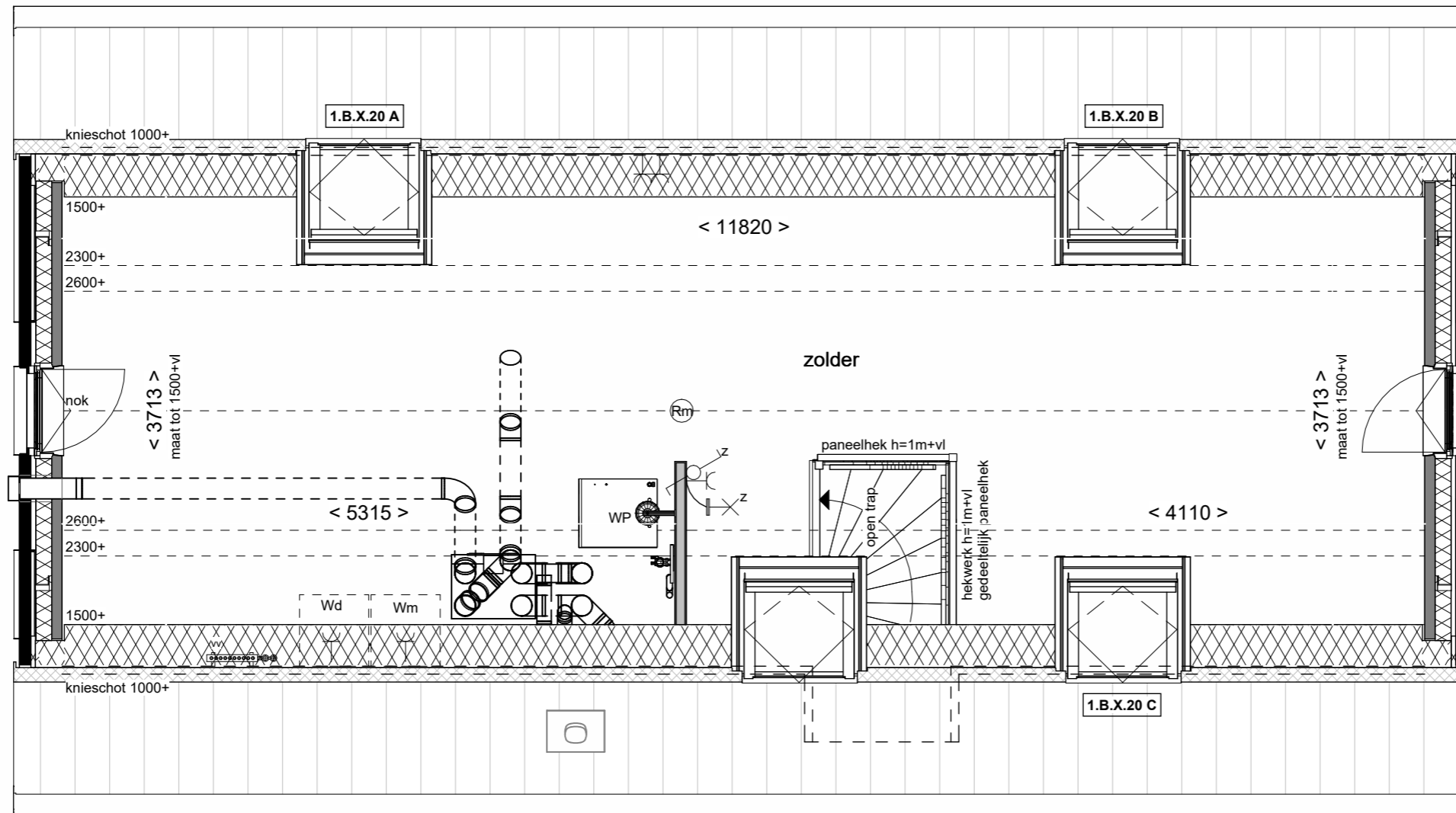

Linkerzijgevel schaal 1:100

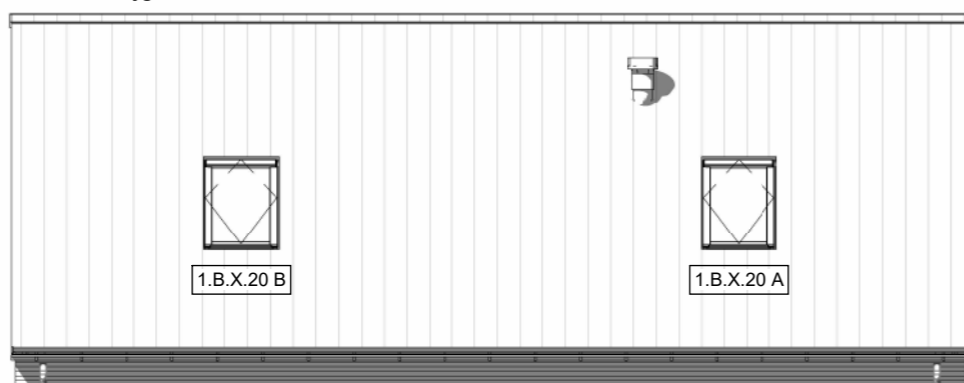

Rechterzijgevel schaal 1:100

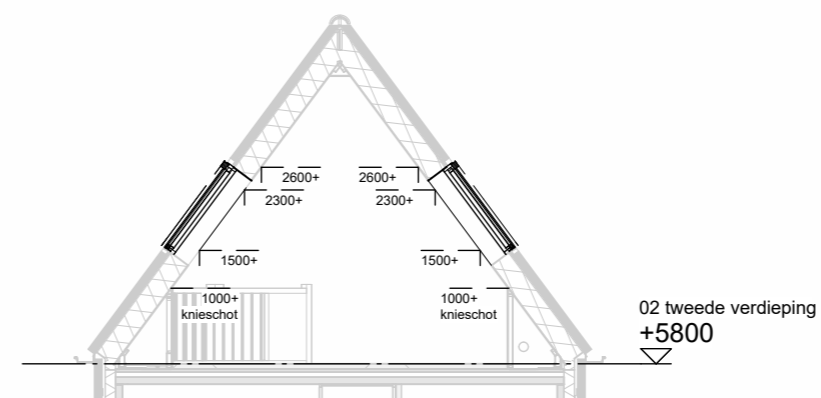

Doorsnede schaal 1:100



Tekening: Dakramen zijgevels

Woningtype: F60+

Bouwnummer: 8/9/14/15/18/19/20

Optienummer: 1.B.X.20

Bladformaat: A3

Schaal: 1:50 / 1:100

Datum: 21-04-2026

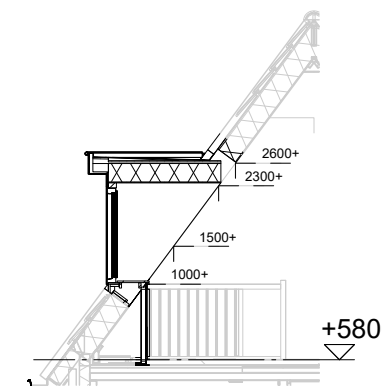
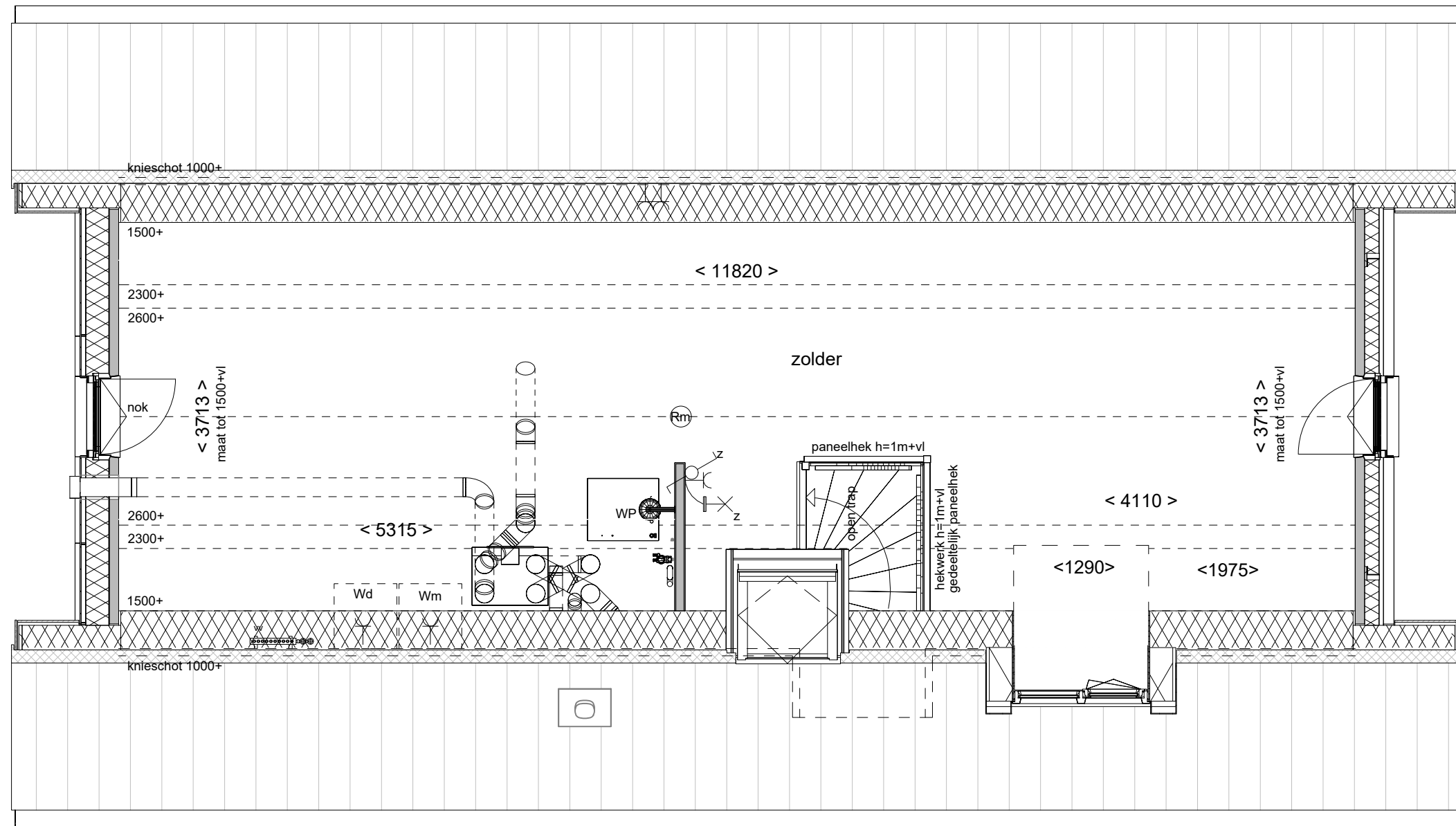

Doorsnede schaal 1:100



Dakkapel zijgevel

Tekening: 130cm

Woningtype: F60+

Bouwnummer: 8/9/14/15/18/19

Optienummer: 1.B.X.36

Bladformaat: A3

Schaal: 1:50 / 1:100

Datum: 21-04-2026

02 tweede verdieping

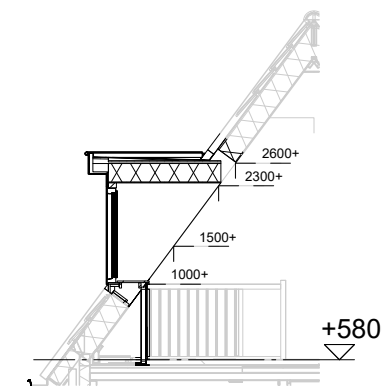
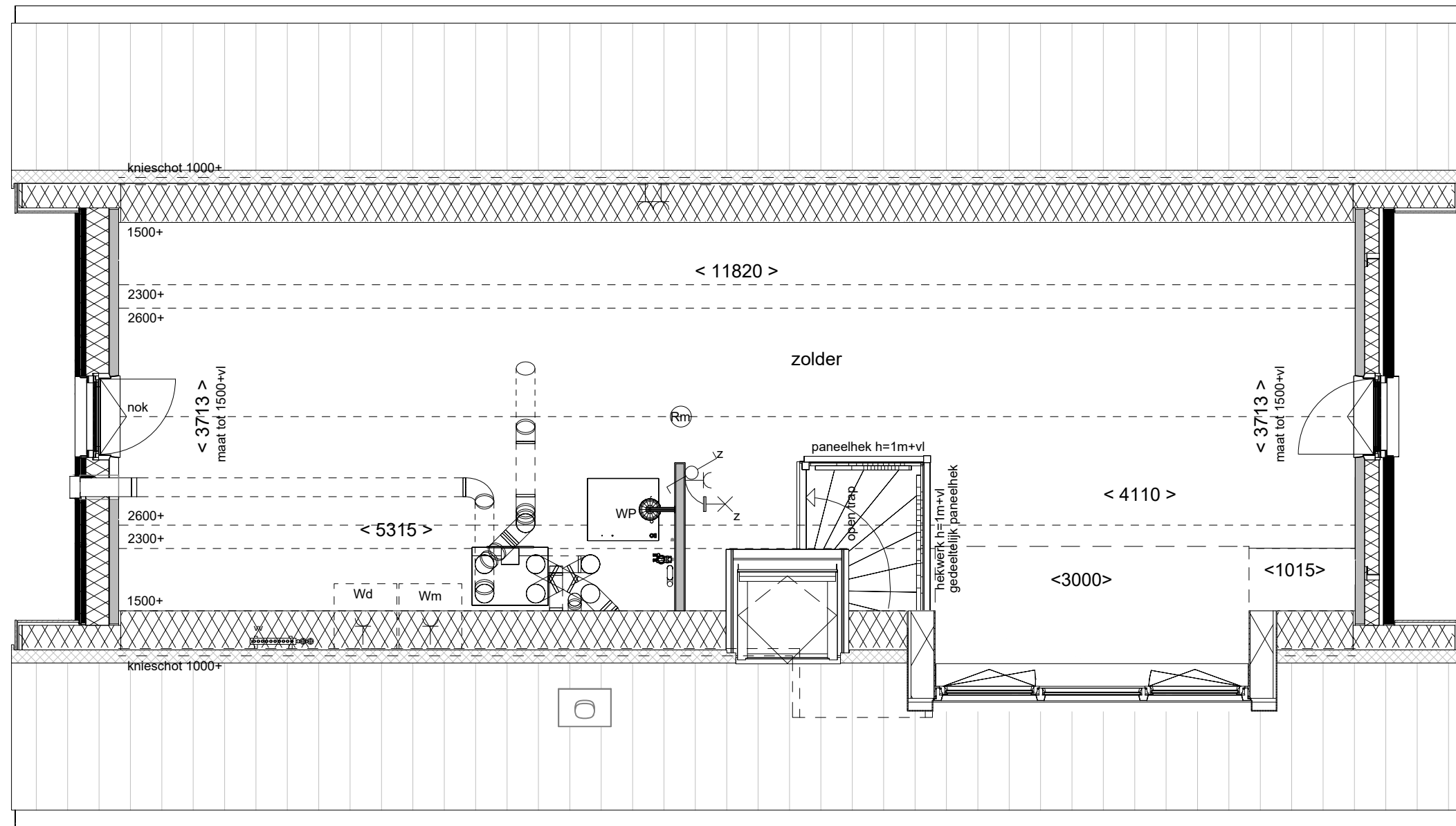

Doorsnede schaal 1:100



Dakkapel zijgevel
300cm

Tekening:

Woningtype: F60+

Bouwnummer: 8/9/14/15/18/19

Optienummer: 1.B.X.38

Bladformaat: A3

Schaal: 1:50 / 1:100

Datum: 21-04-2026

02 tweede verdieping

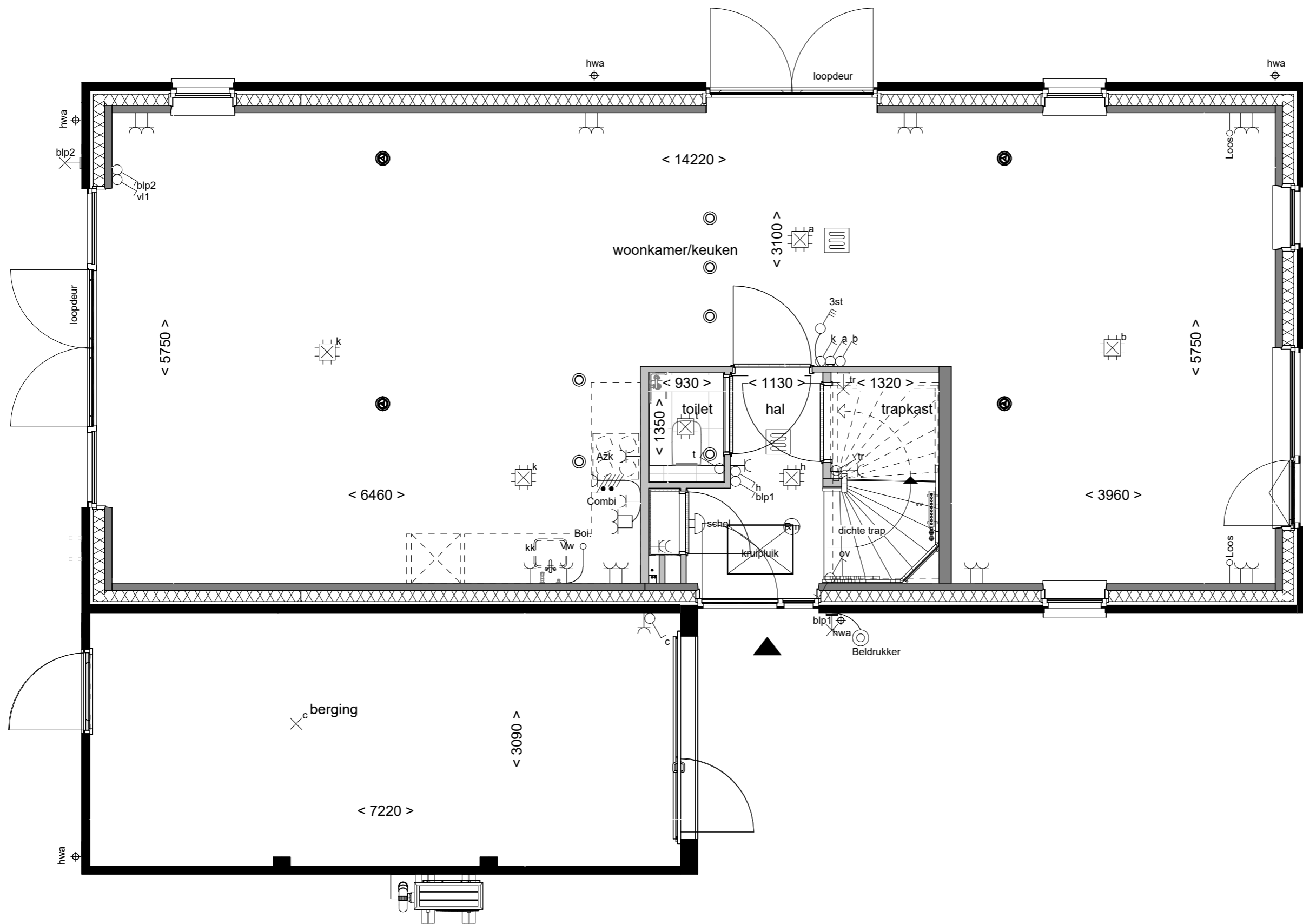

Tekening: Trapkast

Woningtype: F60+

Bouwnummer: 8/9/14/15/18/19/20

Optienummer: 1.C.F.11

Bladformaat: A3

Schaal: 1:50

Datum: 21-04-2026

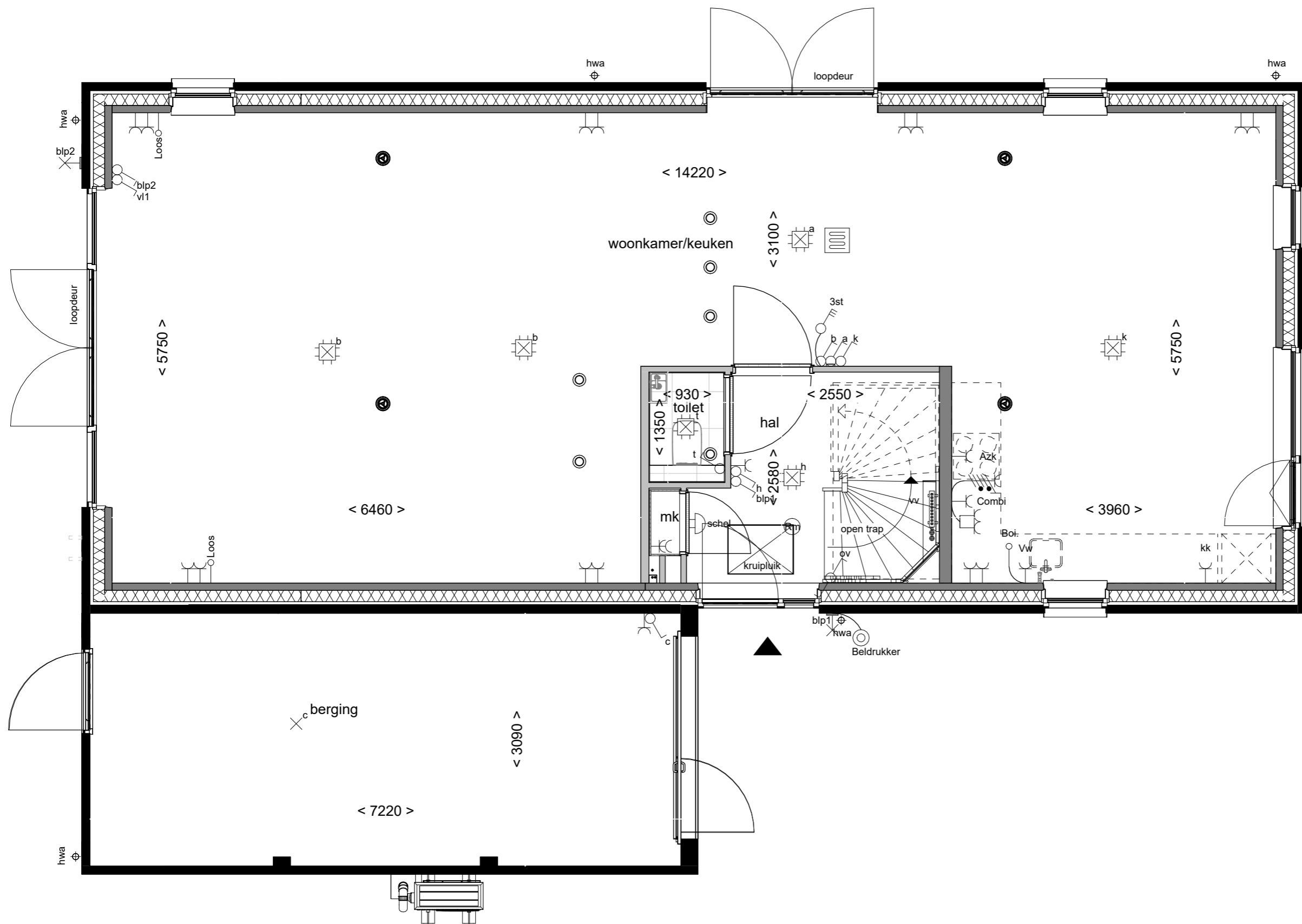

Tekening: Tuingericht wonen

Woningtype: F60+

Bouwnummer: 8/9/14/15/18/19/20

Optienummer: 1.C.F.13

Bladformaat: A3

Schaal: 1:50

Datum: 21-04-2026

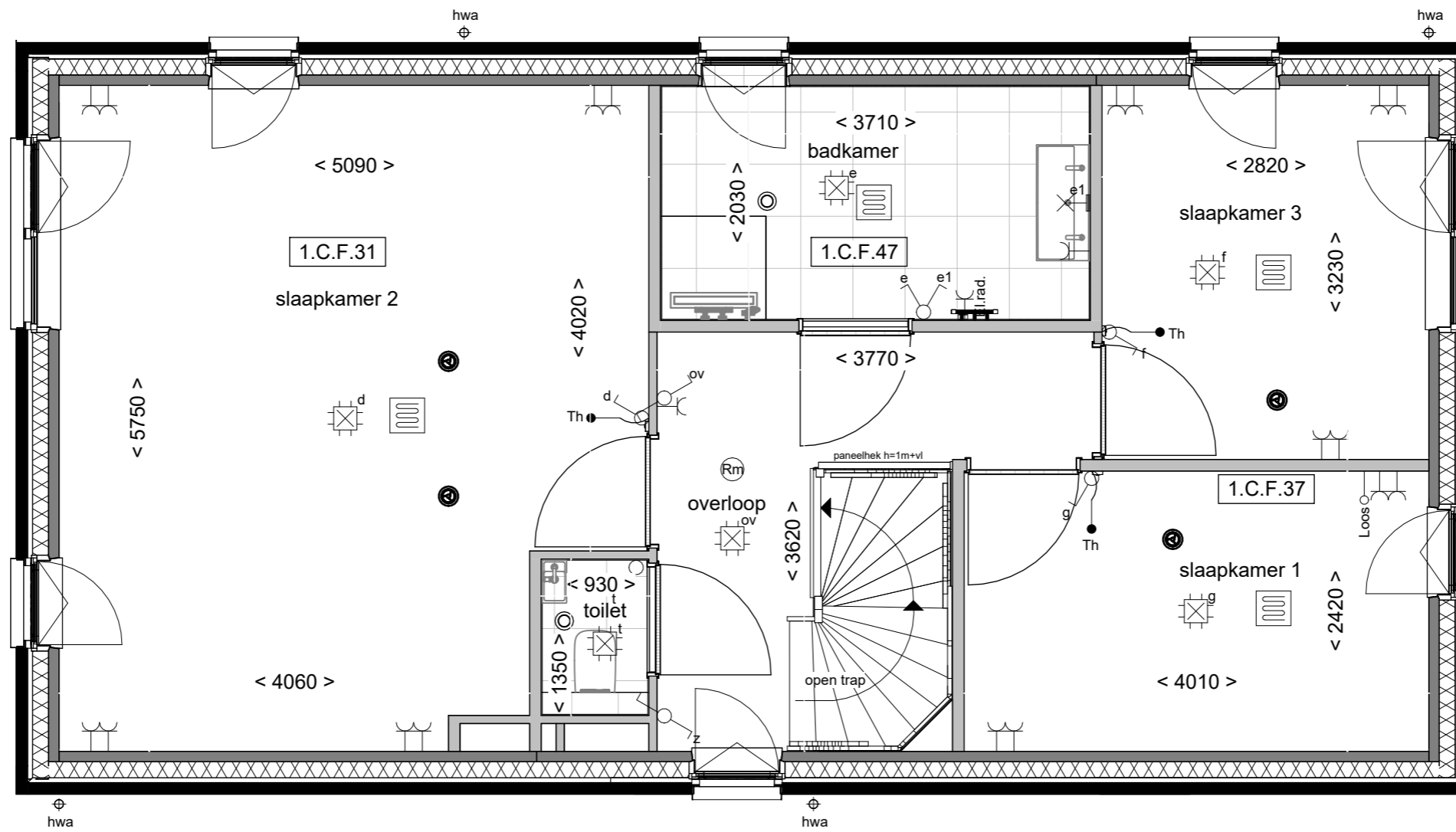

Wonen aan de Gantel
 Vergroten badk.
 indeling 2 slpk voor

Tekening: **indeling 2 slpk voor**

Woningtype: **F60+**

Bouwnummer: **8/9/14/15/18/19/20**

Optienummer: **1.C.F.31/-37/-47**

Bladformaat: **A3**

Schaal: **1:50**

Datum: **21-04-2026**

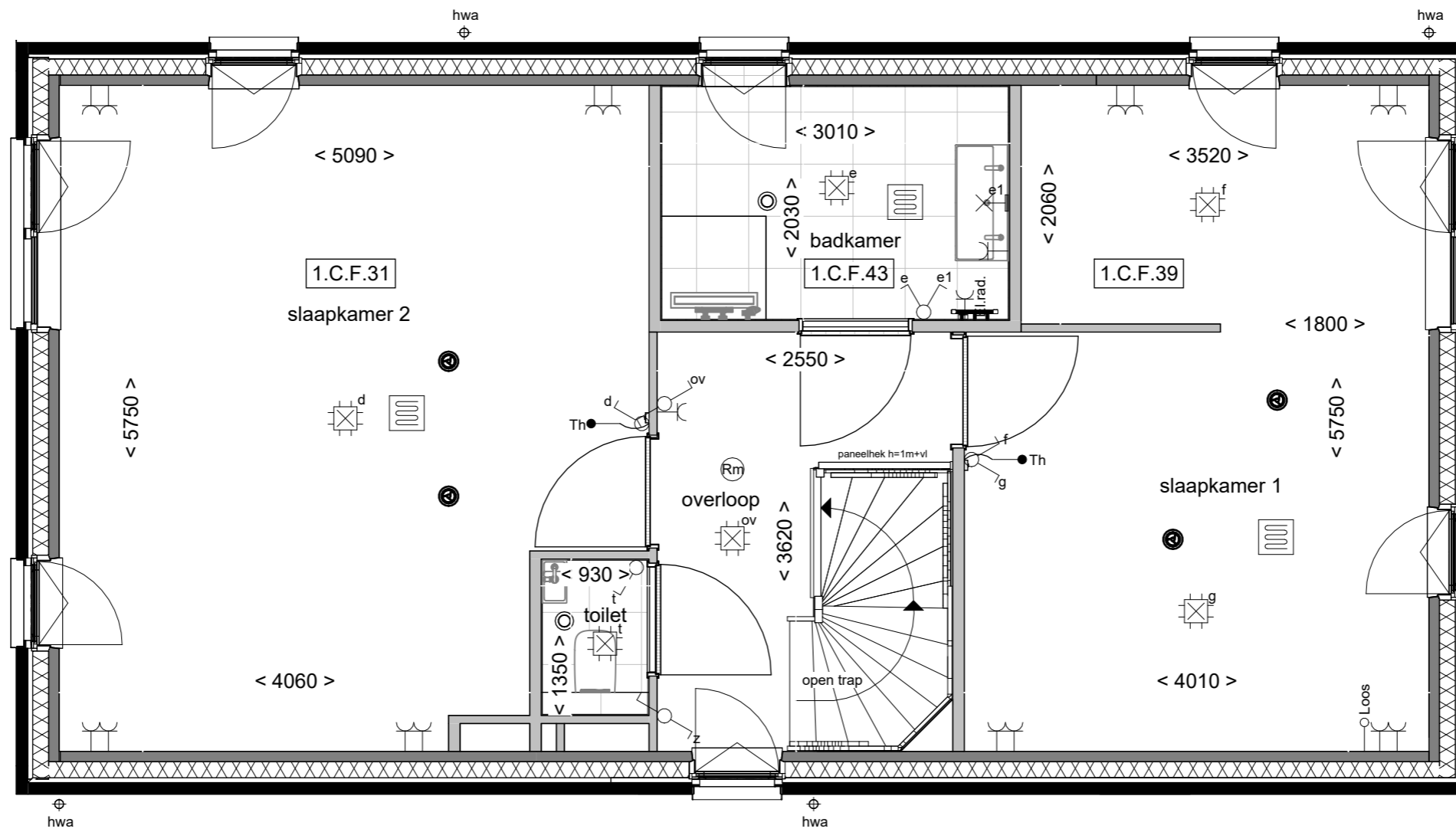

Verbreiden badk
inloopk. slpk voor

Tekening:

Woningtype: F60+

Bouwnummer: 8/9/14/15/18/19/20

Optienummer: 1.C.F.31/-39/-43

Bladformaat: A3

Schaal: 1:50

Datum: 21-04-2026

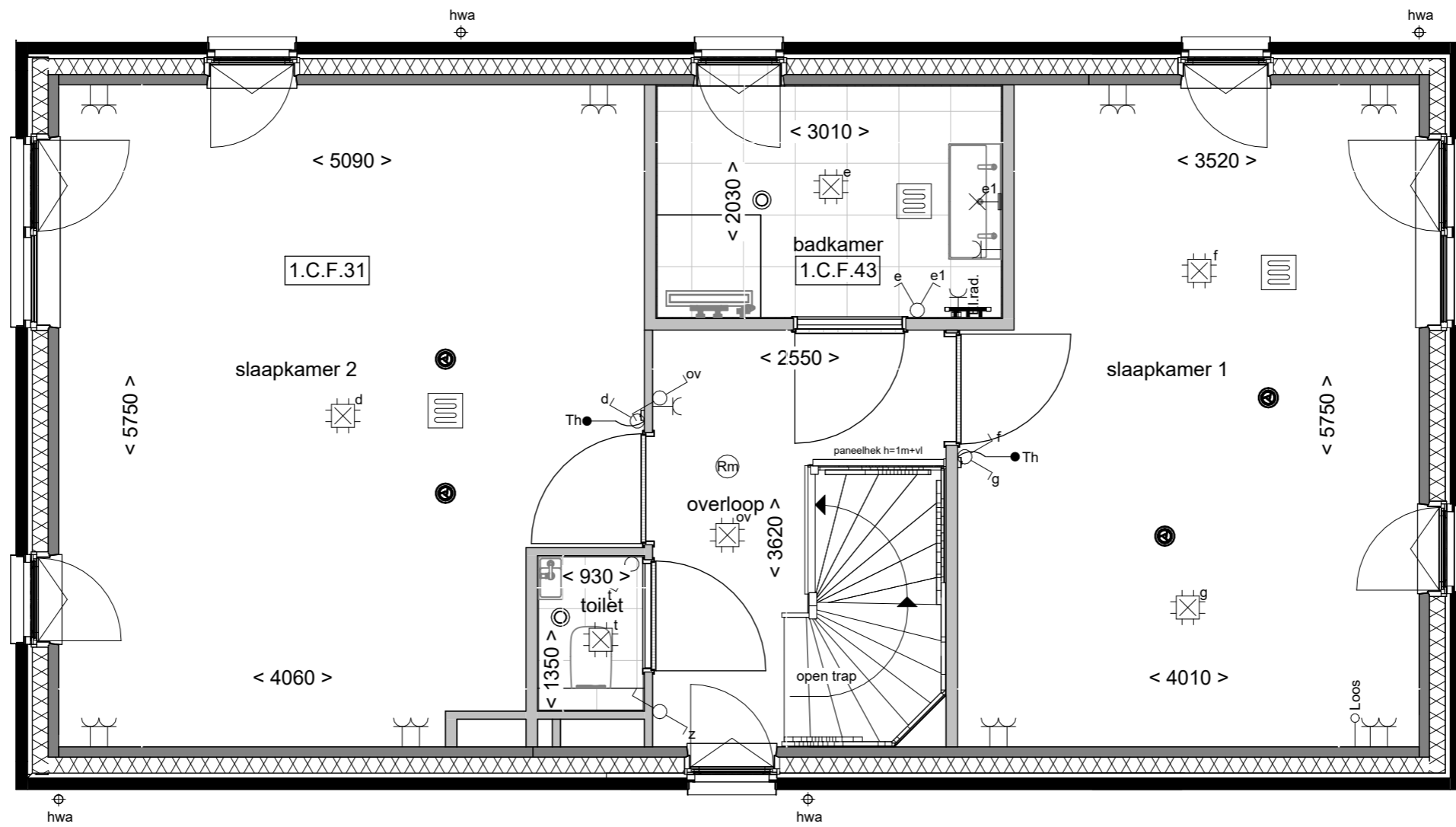

Wonen aan
de Gantel

Tekening: Verbreden badk
samenv.slpk achter

Woningtype: F60+

Bouwnummer: 8/9/14/15/18/19/20

Optienummer: 1.C.F.31/-43

Bladformaat: A3

Schaal: 1:50

Datum: 21-04-2026

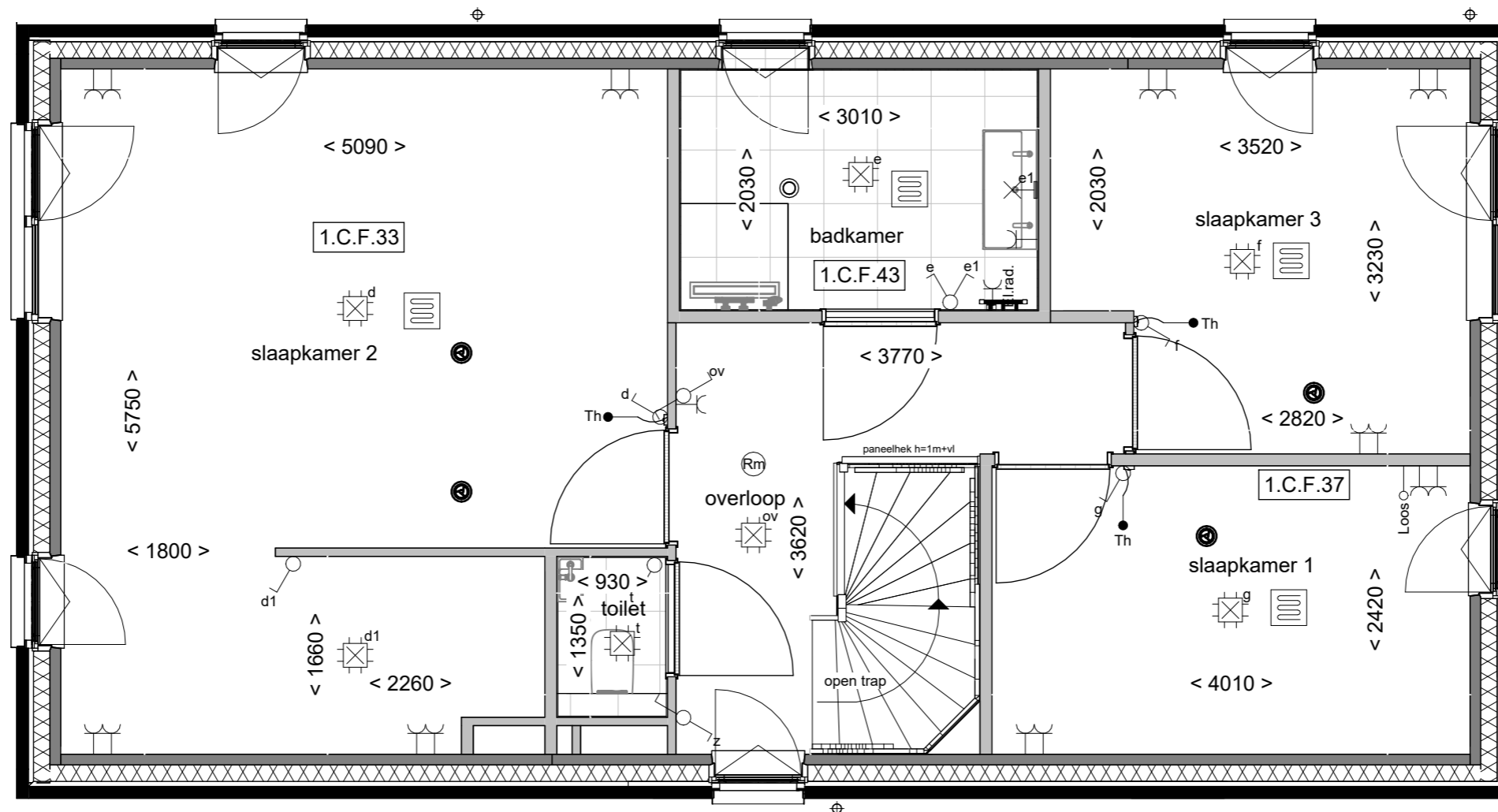

Inloopk. slpk achter
indeling 2 slpk voor

Tekening:

Woningtype: F60+

Bouwnummer: 8/9/14/15/18/19/20

Optienummer: 1.C.F.33/-37/-43

Bladformaat: A3

Schaal: 1:50

Datum: 21-04-2026

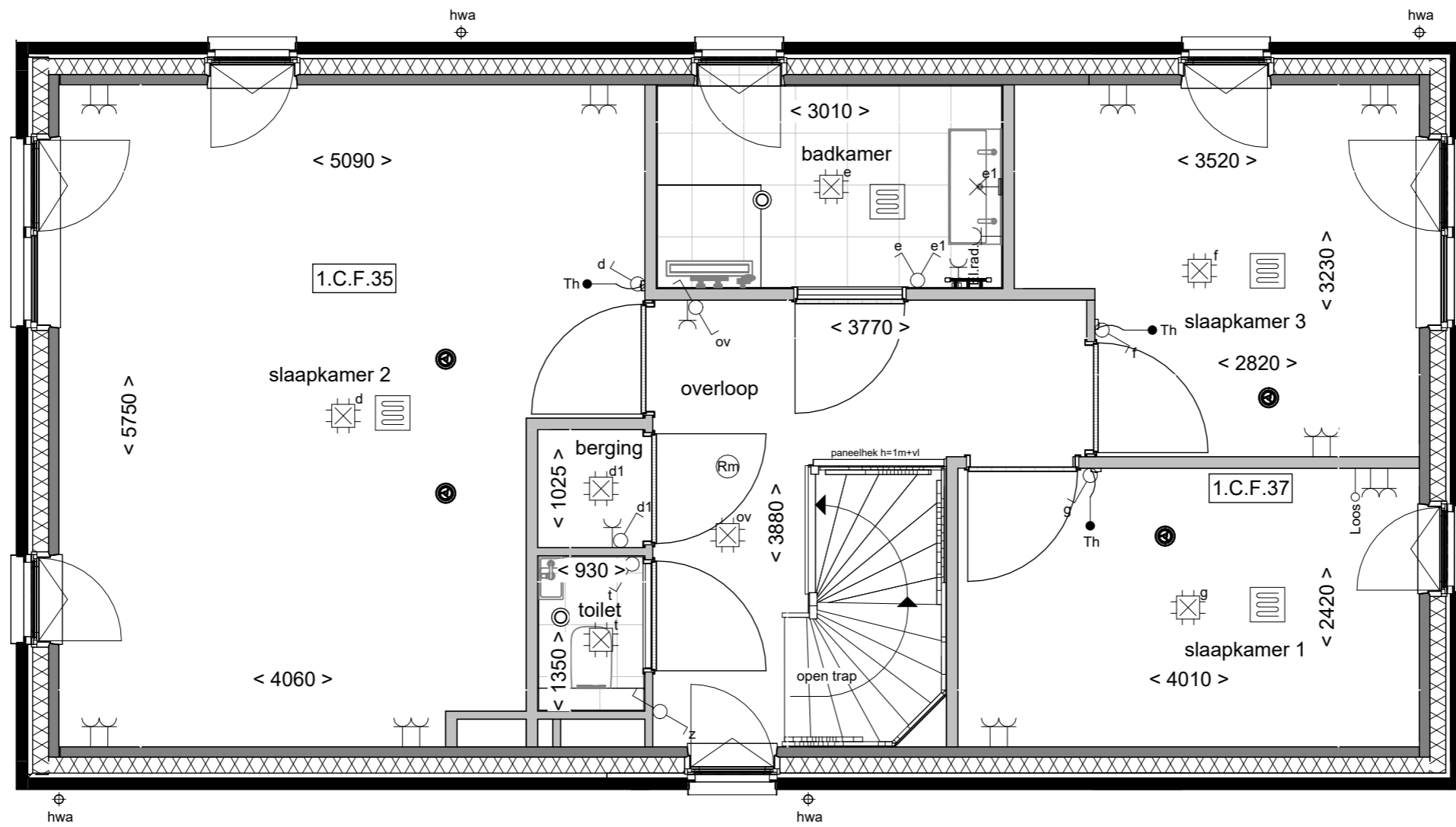

**Wonen aan
de Gantel**

Vaste kast en 2 slpk.
voor

Tekening: voor

Woningtype: F60+

Bouwnummer: 8/9/14/15/18/19/20

Optienummer: 1.C.F.35/-37

Bladformaat: A3

Schaal: 1:50

Datum: 21-04-2026

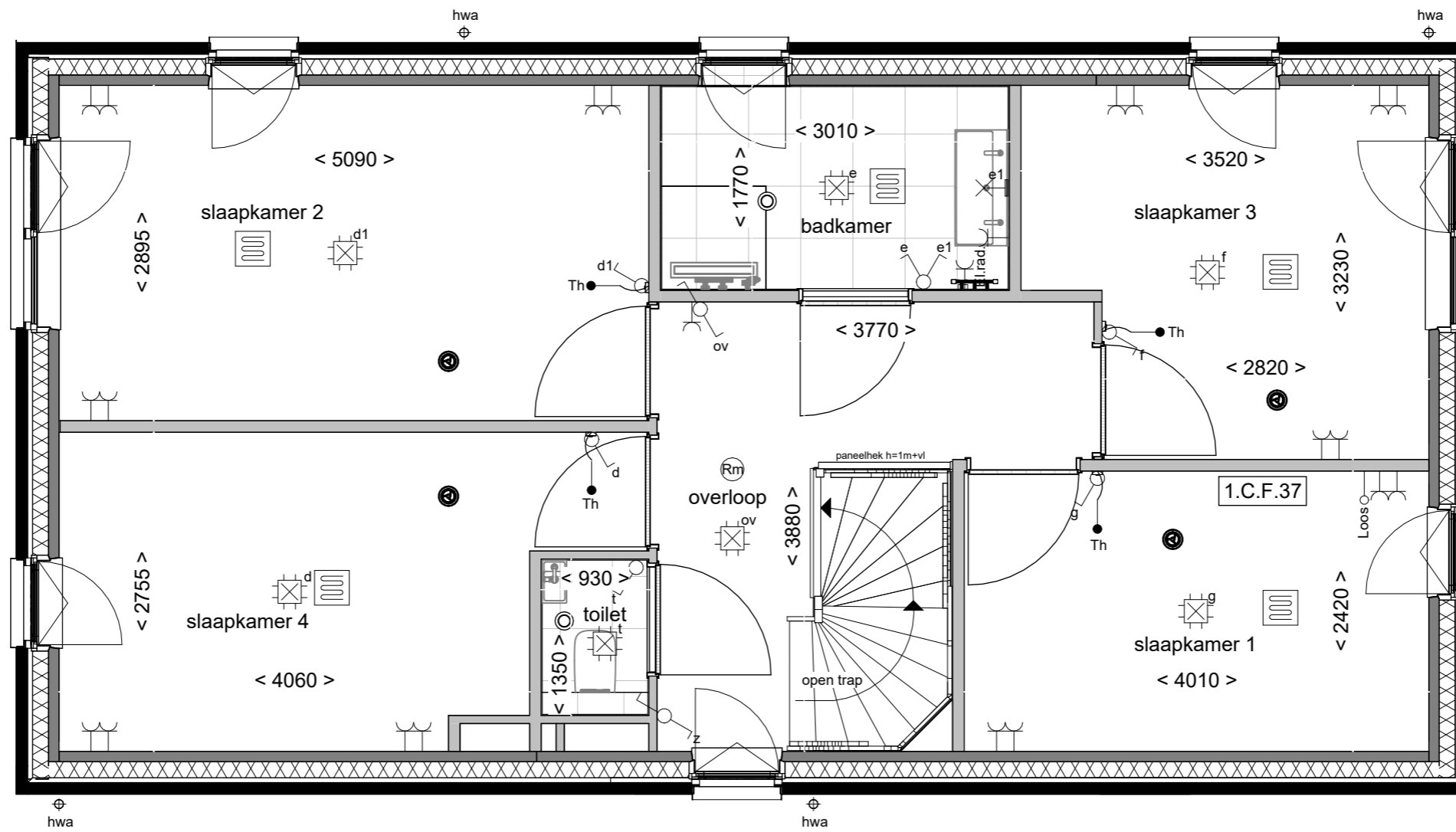

Indeling met 2
slaapkamers voor

Tekening:

Woningtype: F60+

Bouwnummer: 8/9/14/15/18/19/20

Optienummer: 1.C.F.37

Bladformaat: A3

Schaal: 1:50

Datum: 21-04-2026

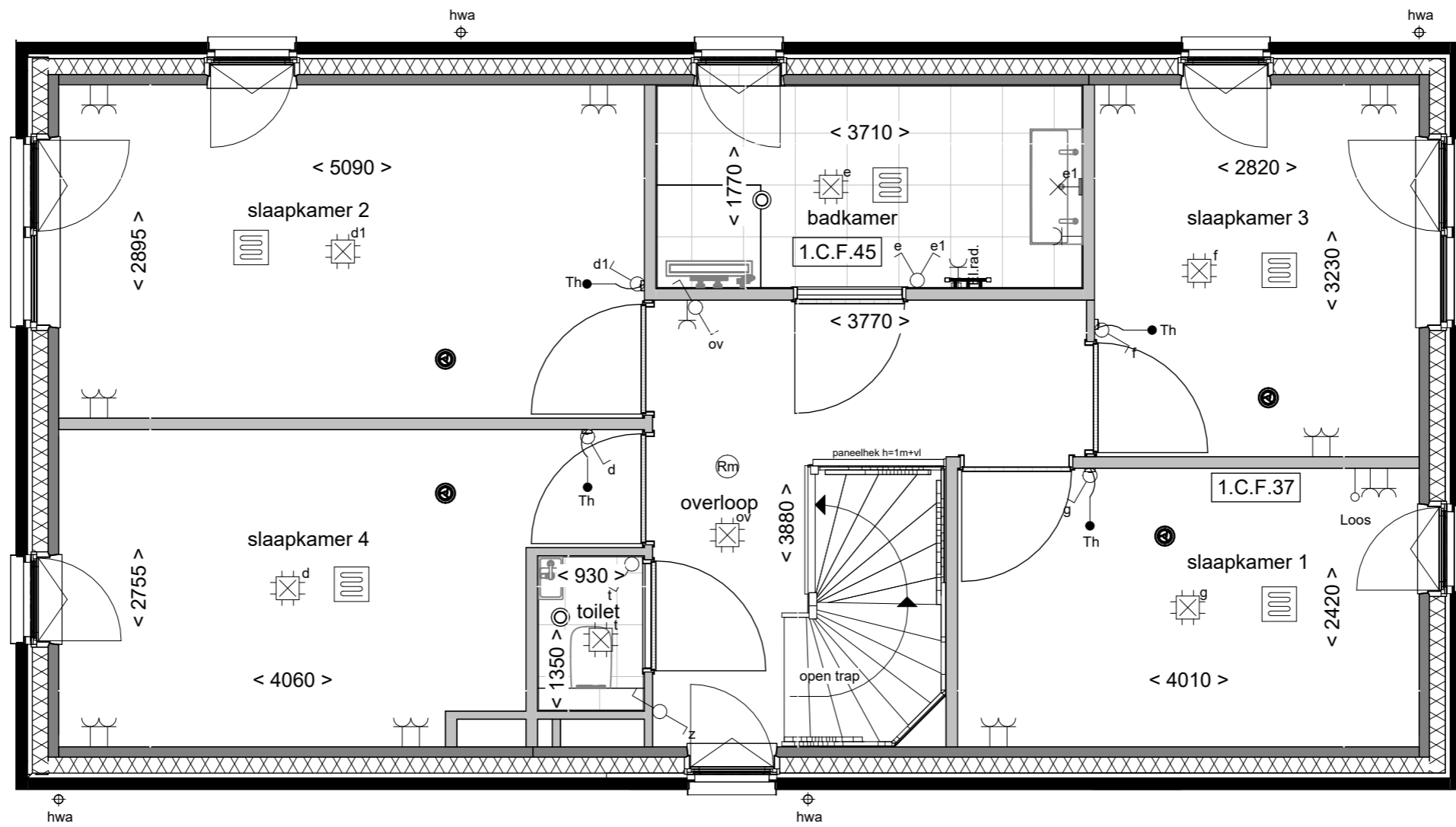

Verlengen badk.
indeling 2 slpk voor

Tekening:

Woningtype: F60+

Bouwnummer: 8/9/14/15/18/19/20

Optienummer: 1.C.F.37/-45

Bladformaat: A3

Schaal: 1:50

Datum: 21-04-2026

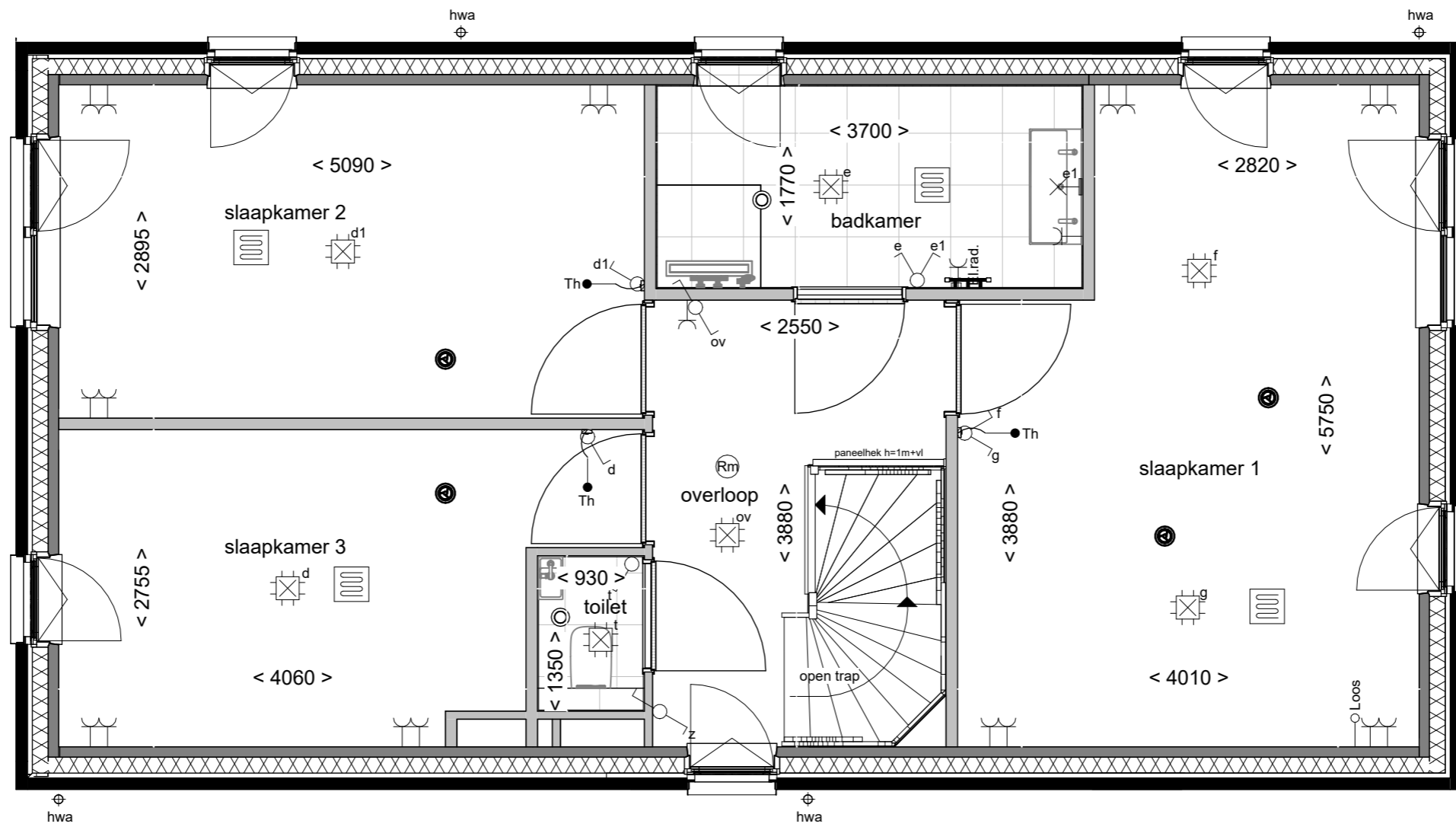

Tekening: Verlengen badkamer

Woningtype: F60+

Bouwnummer: 8/9/14/15/18/19/20

Optienummer: 1.C.F.45

Bladformaat: A3

Schaal: 1:50

Datum: 21-04-2026

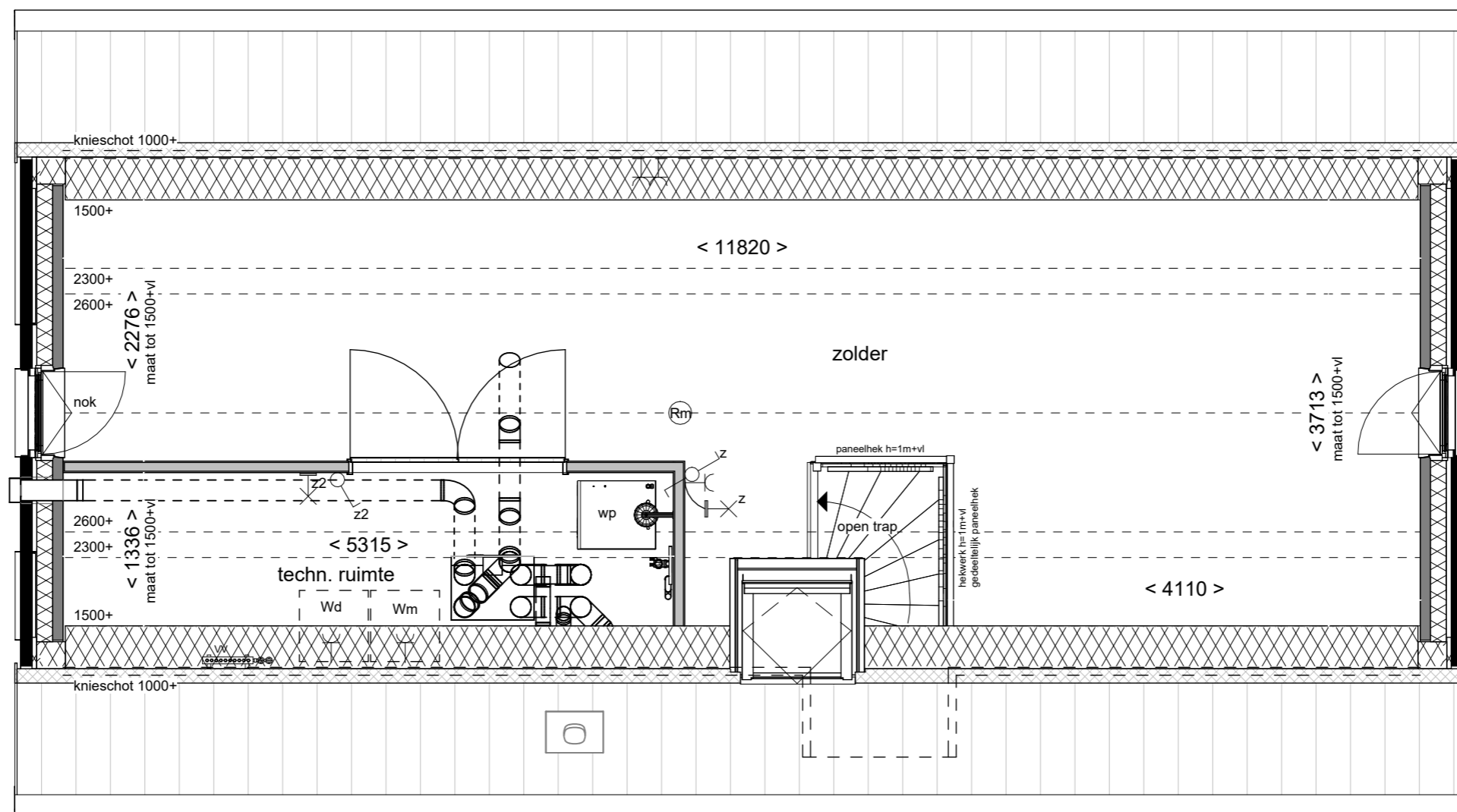

**Indeling met
techniekkast**

Tekening: **Indeling met techniekkast**

Woningtype: **F60+**

Bouwnummer: **8/9/14/15/18/19/20**

Optienummer: **1.C.F.70**

Bladformaat: **A3**

Schaal: **1:50**

Datum: **21-04-2026**

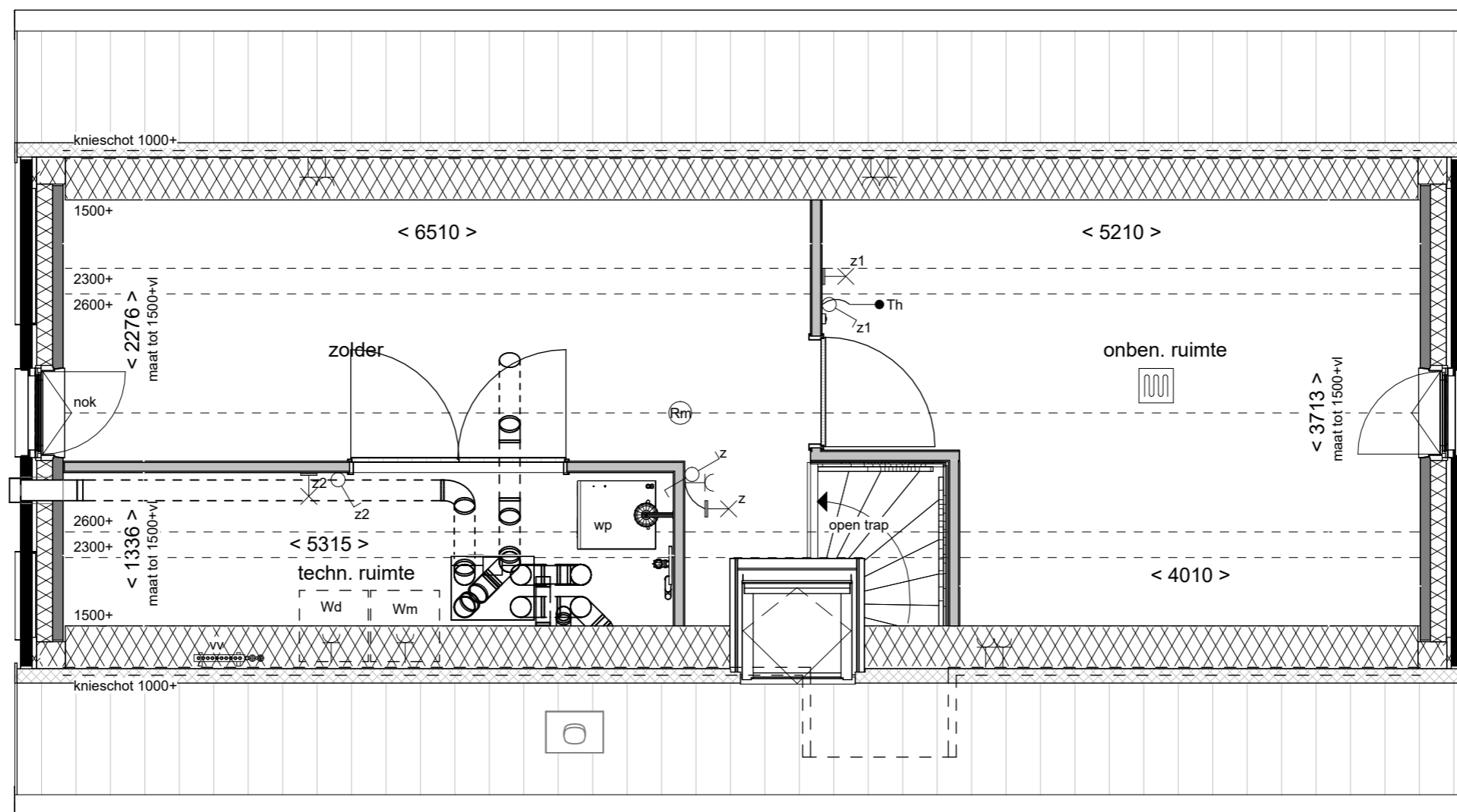

Indeling met één onbenoemde ruimte

Tekening:

Woningtype: F60+

Bouwnummer: 8/9/14/15/18/19/20

Optienummer: 1.C.F.72

Bladformaat: A3

Schaal: 1:50

Datum: 21-04-2026

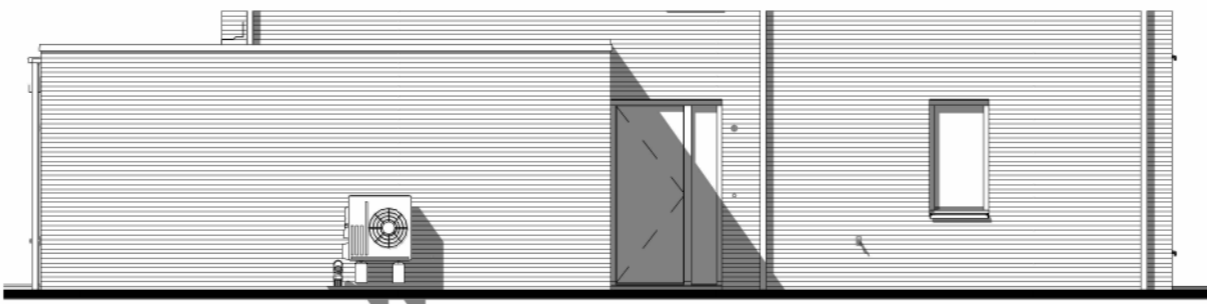
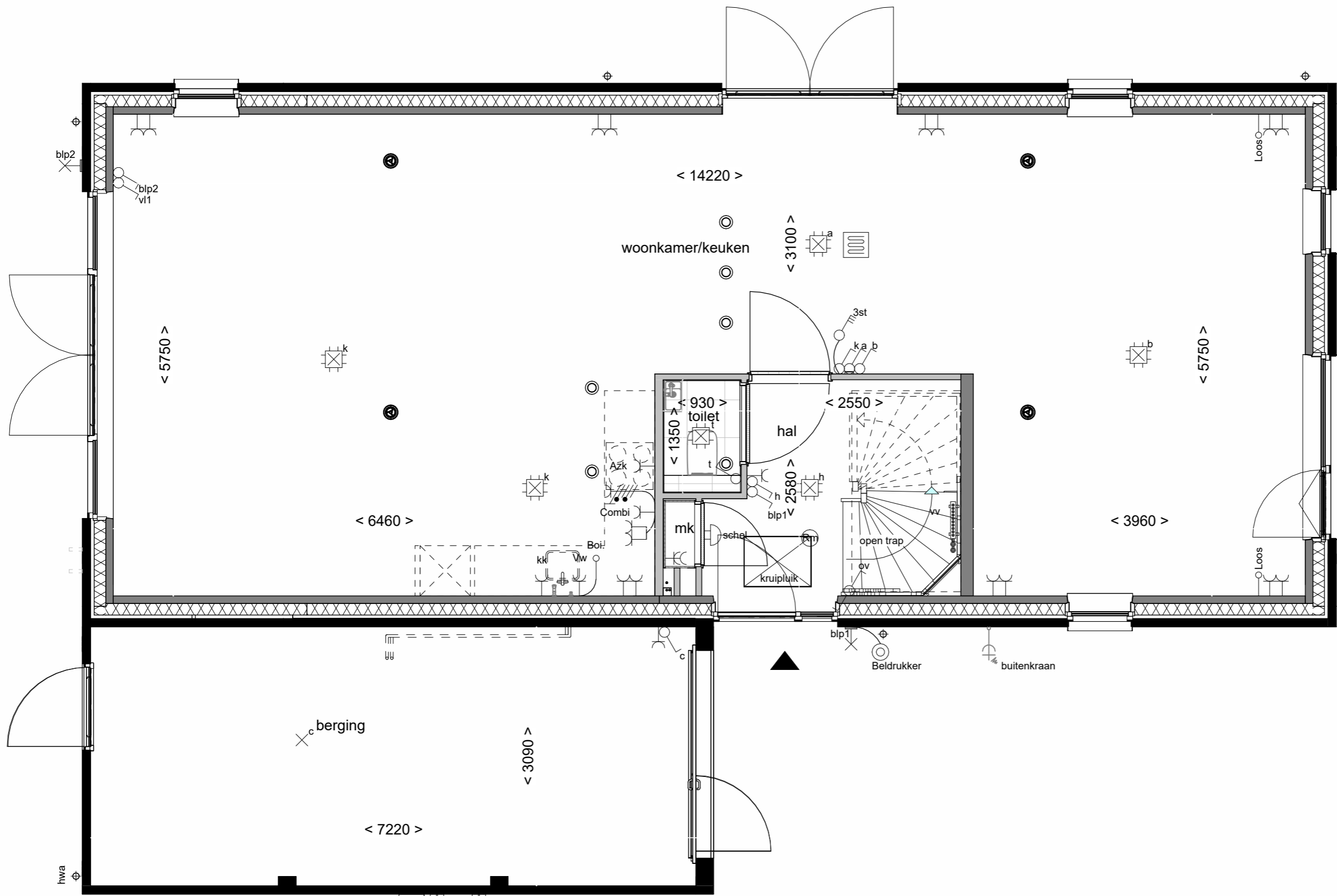

Linkerzijgevel schaal 1:100



vorstvrij buitenkraan
naast voordeur

Tekening:	
Woningtype:	F60+
Bouwnummer:	8/9/14/15/18/19/20
Optienummer:	2.K.0.40
Bladformaat:	A3
Schaal:	1:50 / 1:100
Datum:	21-04-2026

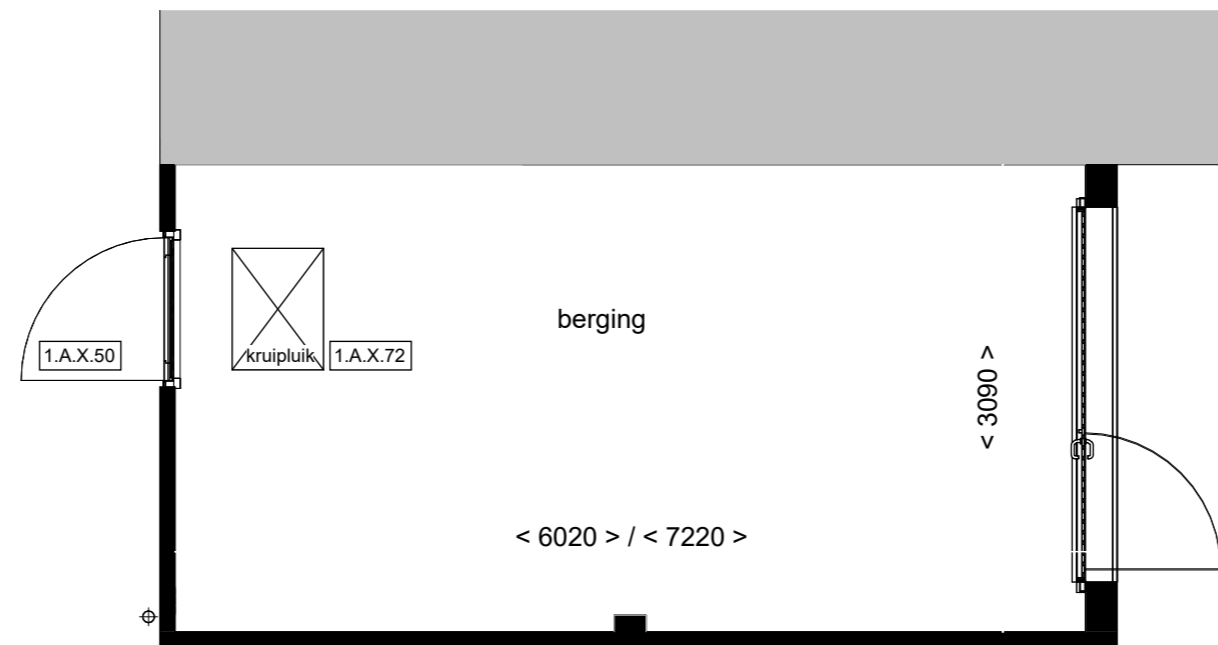

**Wonen aan
de Gantel**

**Kruipluik in de
berging**

Tekening:

Woningtype: E60/F60/F60+/F60D

Bouwnummer: 1 t/m 20

Optienummer: 1.A.X.50 / 1.A.X.72

Bladformaat: A3

Schaal: 1 : 50

Datum: 21-04-2026

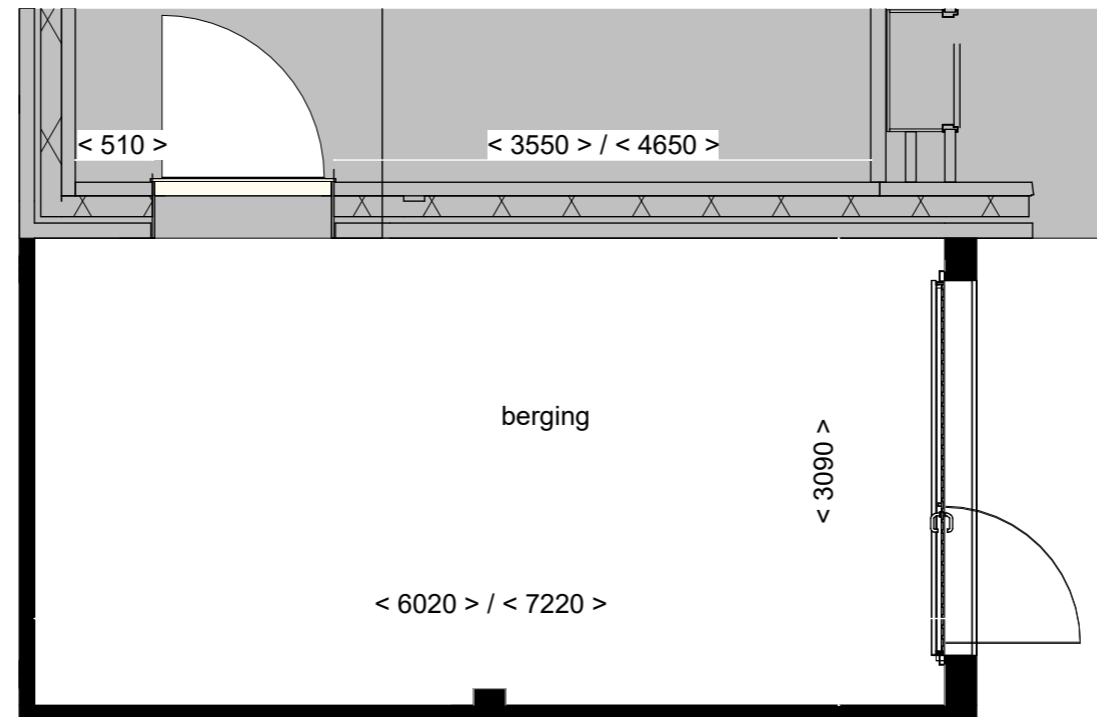

Tekening: Buitendeur tussen
woning en berging

Woningtype: E60/F60/F60+

Bouwnummer: 1 t/m 19

Optienummer: 1.A.X.74 B

Bladformaat: A3

Schaal: 1 : 50

Datum: 21-04-2026

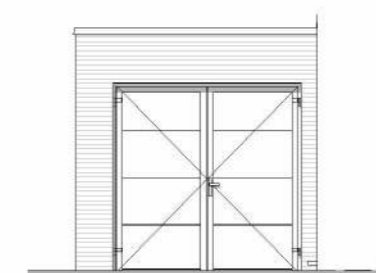
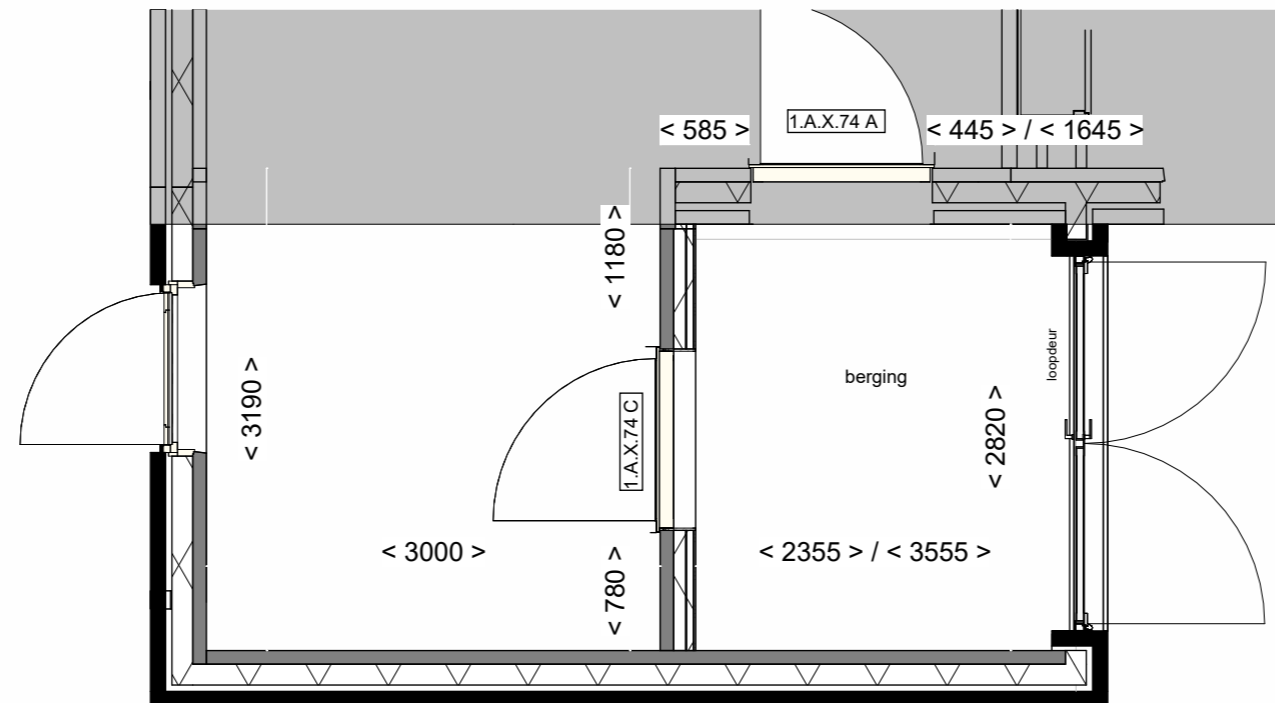

Voorgevel schaal 1:100



Buitendeur tussen
woning en berging

Tekening:

Woningtype: E60/F60/F60+

Bouwnummer: 1 t/m 19

Optienummer: 1.A.X.74 C

Bladformaat: A3

Schaal: 1:50

Datum: 21-04-2026

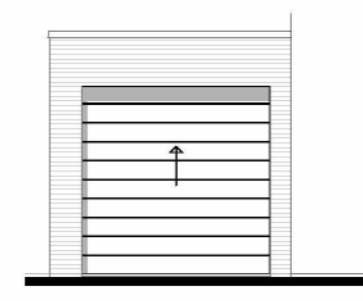
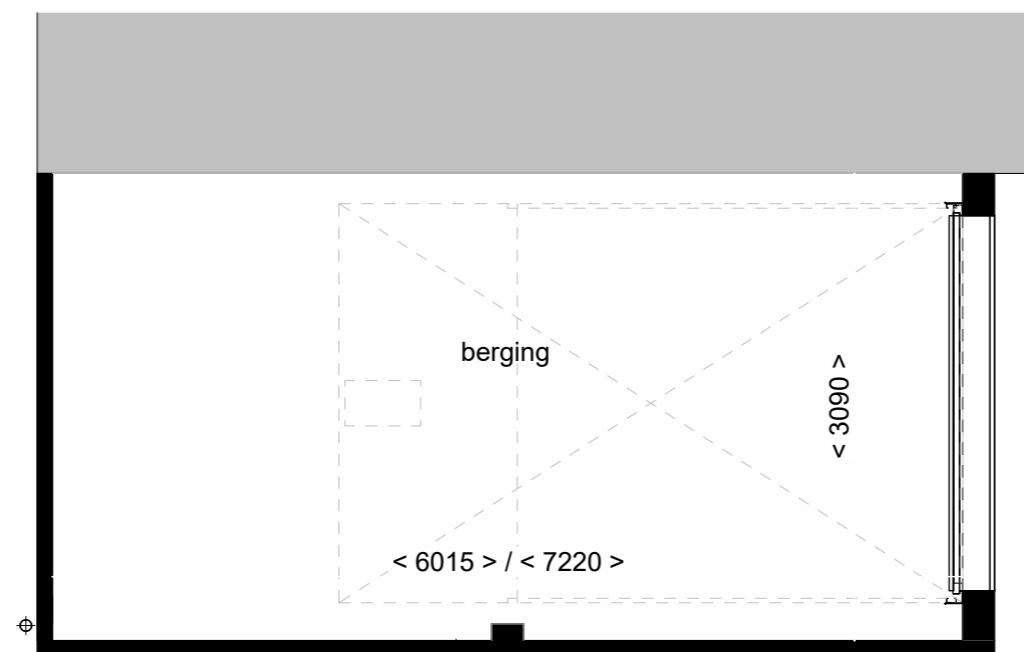

Voorgevel schaal 1:100



**Wonen aan
de Gantel**

Sectionaaldeur ipv
kanteldeur

Tekening:

Woningtype: E60/F60/F60+/F60D

Bouwnummer: 1 t/m 20

Optienummer: 1.A.X.80

Bladformaat: A3

Schaal: 1:50

Datum: 21-04-2026

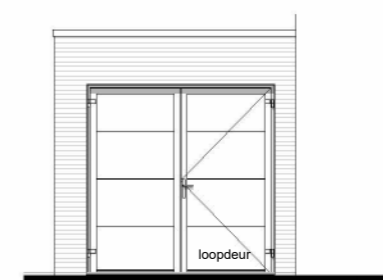
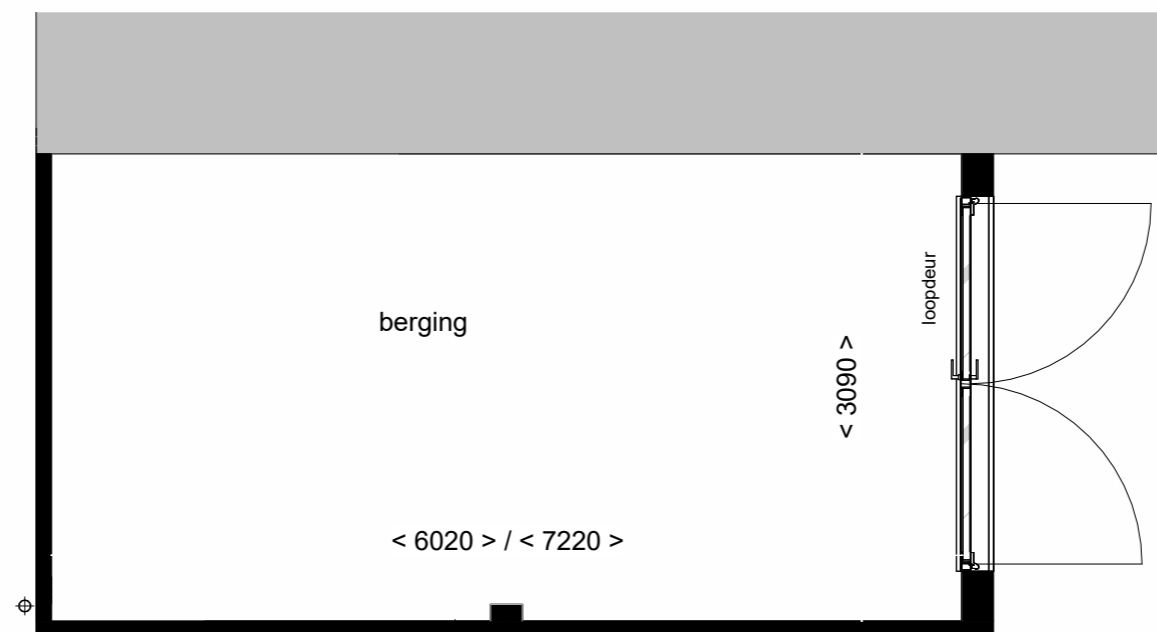

Voorgevel schaal 1:100



**Wonen aan
de Gantel**

Dubbele
openslaande deuren

Tekening: **Dubbele
openslaande deuren**

Woningtype: **E60/F60/F60+/F60D**

Bouwnummer: **1 t/m 20**

Optienummer: **1.A.X.84**

Bladformaat: **A3**

Schaal: **1:50**

Datum: **21-04-2026**

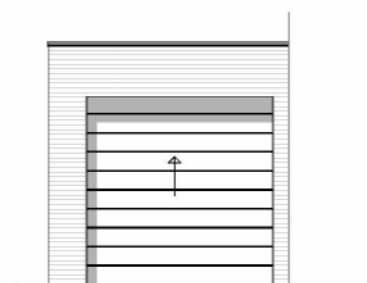
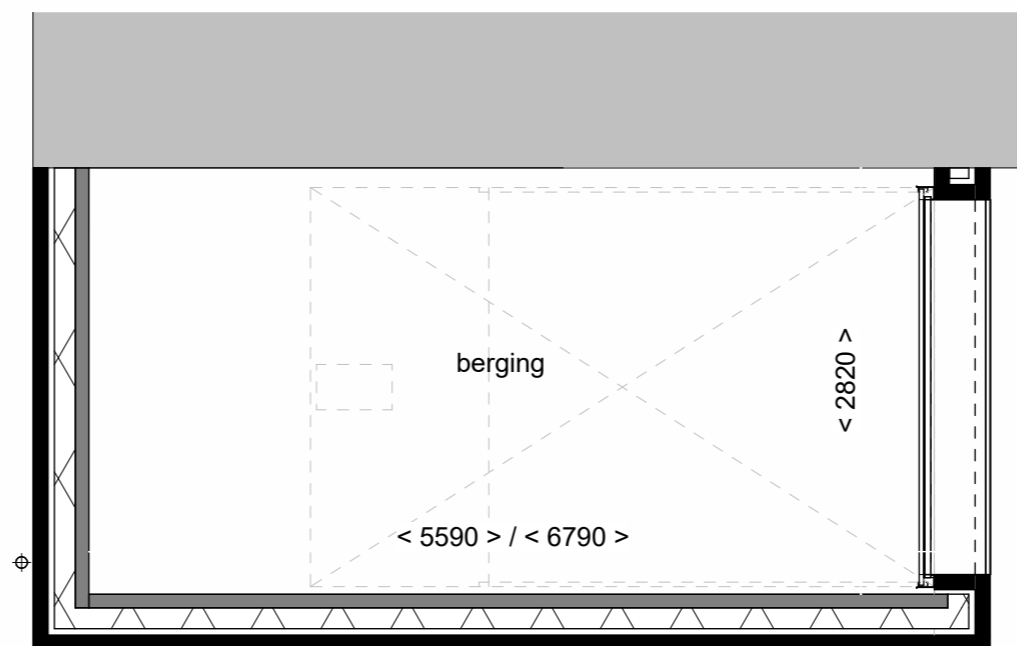

Voorgevel schaal 1:100



Achtergevel schaal 1:100



**Wonen aan
de Gantel**

Tekening: **Isoleren berging**

Woningtype: **E60/F60/F60+/F60D**

Bouwnummer: **01 t/m 20**

Optienummer: **1.A.X.86**

Bladformaat: **A3**

Schaal: **1:50**

Datum: **21-04-2026**

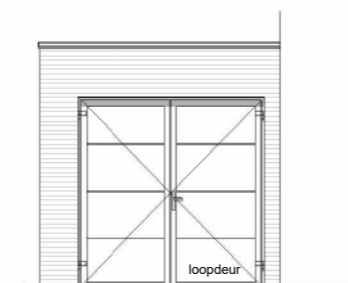
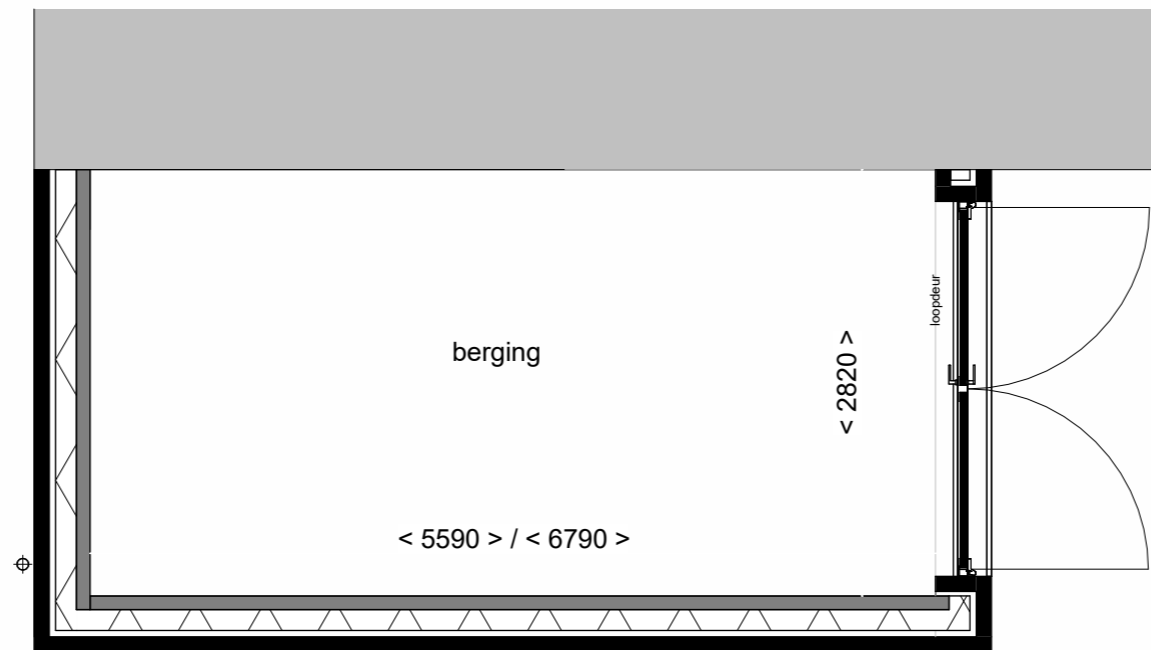

Voorgevel schaal 1:100



Achtergevel schaal 1:100



**Wonen aan
de Gantel**

Dubbele deuren,
isoleren

Tekening:

Woningtype: E60/F60/F60+/F60D

Bouwnummer: 1 t/m 20

Optienummer: 1.A.X.94

Bladformaat: A3

Schaal: 1:50

Datum: 21-04-2026