

Renvooi

-  - entree woongebouw
-  - erfgrans
-  - parkeervak eigen terrein
-  - parkeervak openbaar
-  - houten vlonder
-  - pergola
-  - haag laag
-  - haag hoog
-  - water
-  - openbaar groen
-  - wandelpad houtsnippers
-  - voetpad
-  - inrit
-  - straat
-  - talud
-  - boom, positie in overleg met koper
-  - indicatie positie riolering
-  - zone erfdienstbaarheid
-  - klinkerbestrating

parkeerplekken en posities bomen indicatief



Tekening: **Situatie totaal**

Woningtype: **E60,E60D,F60,F60+**

Bouwnummer: **1 t/m 31**

Bladnummer: **VT-S-00**

Bladformaat: **A3**

Schaal: **1:750**

Datum: **21-04-2026**



Renvooi

-  - entree woongebouw
-  - erfgrans
-  - parkeervak eigen terrein
-  - parkeervak openbaar
-  - houten vlonder
-  - pergola
-  - haag laag
-  - haag hoog
-  - water
-  - openbaar groen
-  - wandelpad houtsnippers
-  - voetpad
-  - inrit
-  - straat
-  - talud
-  - boom, positie in overleg met koper
-  - indicatie positie riolering
-  - zone erfdienstbaarheid
-  - klinkerbestrating

parkeerplekken en posities bomen indicatief



Tekening: Situatie bnr. 6-8

Woningtype: E60, E60D, F60+

Bouwnummer: 6, 7, 8

Bladnummer: VT-S-02

Bladformaat: A3









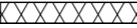

Schaal: 1:200

Datum: 21-04-2026

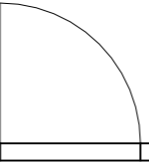
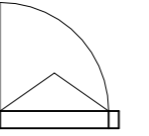
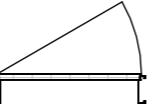
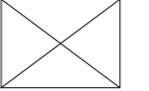



















Renvooi materialen

	dakpan antracietgrijs
	metselwerk kleur grijswit gesinterd code A: EN1166 WF WS
	metselwerk kleur bruin nuance code B: HM1106 WF WS
	metselwerk kleur bruin caramel code C: EN1165 WF WS
	gevelbetimmering vuren vergrijsd

Renvooi bouwkundig

	entree woning
	metselwerk
	isolatie
	dragende wand
	niet dragende binnenwand
	buitendeur
	draairaam
	binnendeurkozijn (met bovenlicht)
	kruipluik
	opstelplaats wasmachine
	opstelplaats wasdroger
	opstelplaats koelkast
	principe opstelling keukenblok
	onbenoemde ruimte volgens krijtstreepmethode

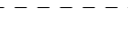
Renvooi installaties

	aansluitpunt licht, wand
	centraaldoos met lichtpunt
	armatuur aan de wand
	rookmelder
	aansluitpunt niet bedraad / loos
	aansluitpunt bedraad data, niet afgemonteerd
	beldrukker
	schel
	schakelaar, 1-polig
	werkschakelaar tbv PV-panelen
	driestandenschakelaar tbv wtw
	schakelaar, wissel
	schakelaar, serie
	pulsschakelaar tbv warmteterugwinunit
	wandcontactdoos 1-voudig met beschermingscontact
	wandcontactdoos 2-voudig met beschermingscontact
	thermostaatleiding, bedraad
	wandcontactdoos tbv warmteterugwinunit
	wtw mechanische ventilatie-unit incl. warmteterugwinunit
	wp warmtepomp
	inblaasventiel mechanische ventilatie
	afzuigventiel mechanische ventilatie
	vv verdeler vloerverwarming
	ruimte vzv vloerverwarming
	rad elektrische radiator
	kanalen in het zicht
	doucheput
	lijngoot douche
	buitenkraan

Disclaimer

De op deze tekeningen aangegeven maten zijn circa maten in millimeters en tussen de wanden / vloeren gemeten, waarbij geen rekening is gehouden met enige wandafwerking, plinten, aftimmering, etc. In verband met de nauwkeurige uitwerking van details, constructie, maatvoering, materialen e.d. kunnen er kleine afwijkingen ontstaan ten opzichte van de nu vermelde gegevens. Deze geringe afwijkingen geven geen aanleiding tot verrekening. Aan de op deze tekening aangegeven maten kunnen derhalve geen rechten worden ontleend. De op deze tekeningen aangegeven maatvoering is niet geschikt voor opdrachten aan derden door koper(s). De posities van aansluitingen en installatie onderdelen zijn indicatief op tekening aangegeven. De exacte aantallen en posities zullen na berekening in het werk door de installateurs worden bepaald en kunnen afwijken van deze tekening.



Tekening:	Renvooi
Woningtype:	E60 / F60 / F60+
Bouwnummer:	1 t/m 31
Bladnummer:	VT-0-00c
Bladformaat:	A3
Schaal:	1 : 50
Datum:	21-04-2026



Vorgevel

Type: E60D
bnr: 6

Type: E60
bnr: 7

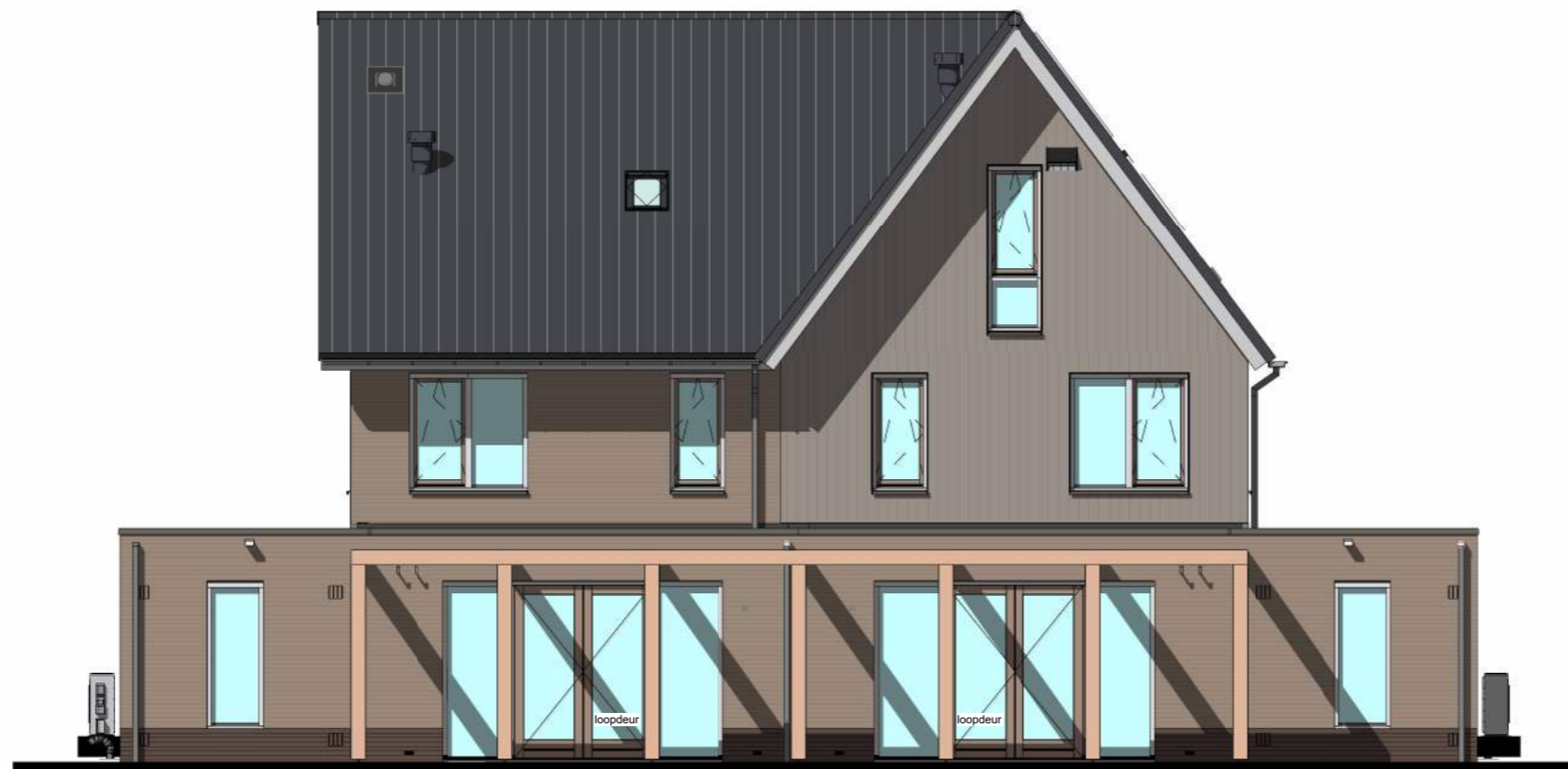

Achtergevel

Type: E60
bnr: 7

Type: E60D
bnr: 6



Tekening: Gevels blok 4

Woningtype: E60D / E60

Bouwnummer: 6 / 7

Bladnummer: VT-04-00a

Bladformaat: A3

Schaal: 1 : 100

Datum: 21-04-2026



Linker zijgevel

Type: E60D
bnr: 6



Rechter zijgevel

Type: E60
bnr: 7



Tekening: Zijgevels blok 4

Woningtype: E60D / E60

Bouwnummer: 6 / 7

Bladnummer: VT-04-00b

Bladformaat: A3

Schaal: 1 : 100

Datum: 21-04-2026

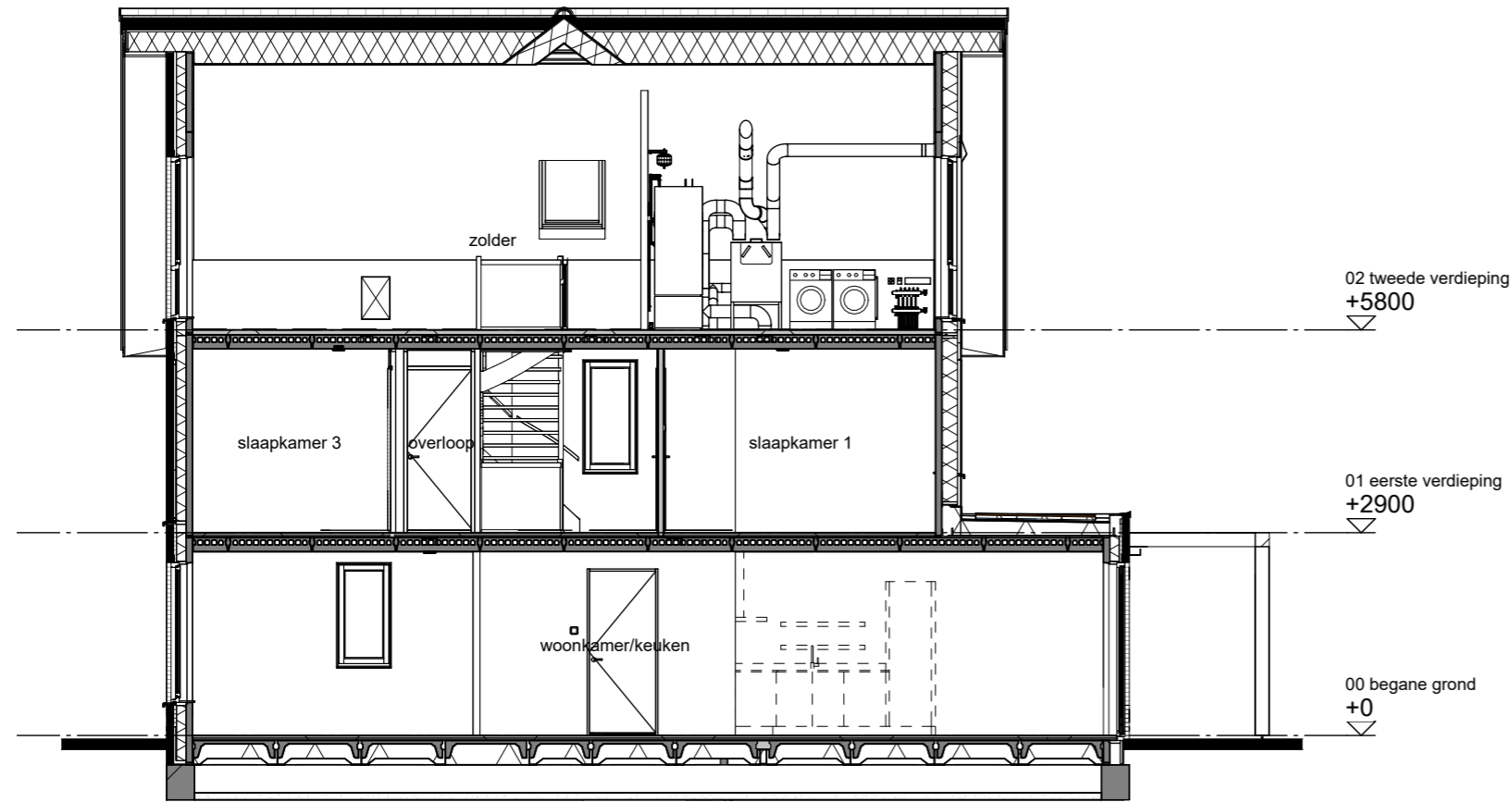

Doorsnede A-A

Type: E60D
bnr: 6

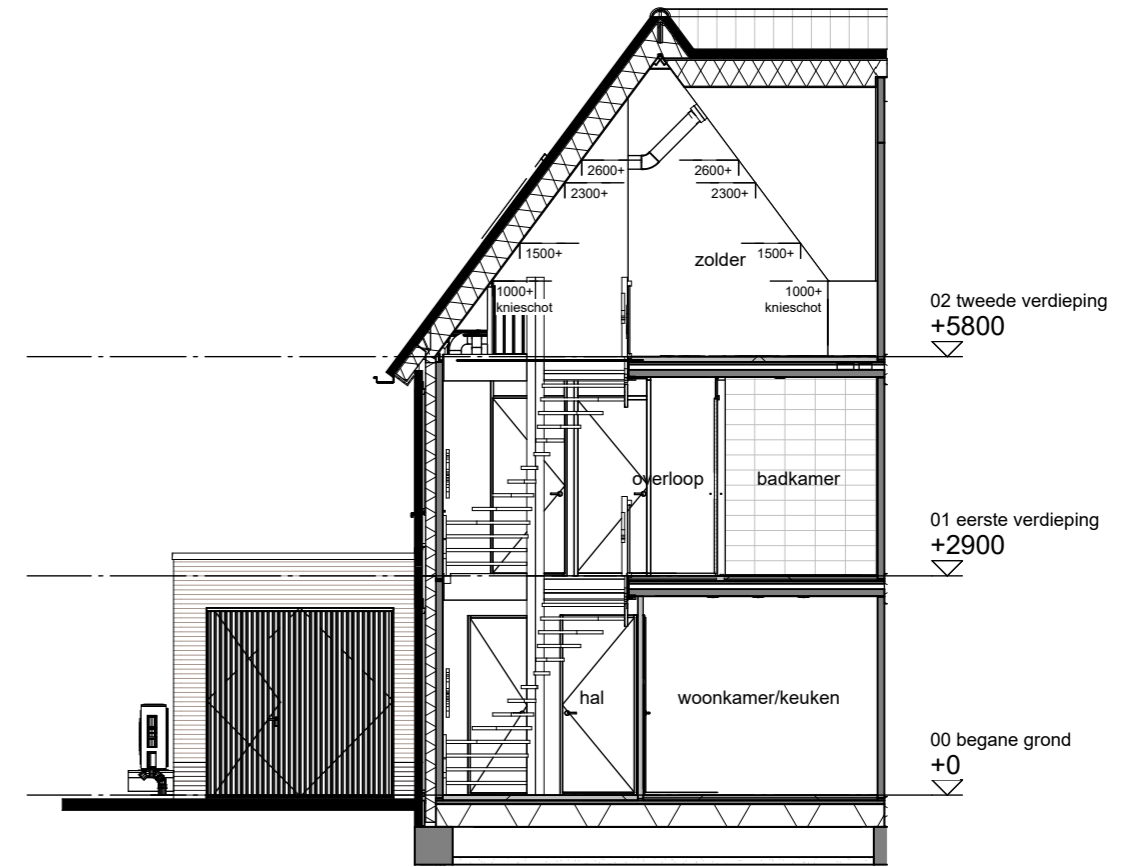

Doorsnede C-C

Type: E60D
bnr: 6

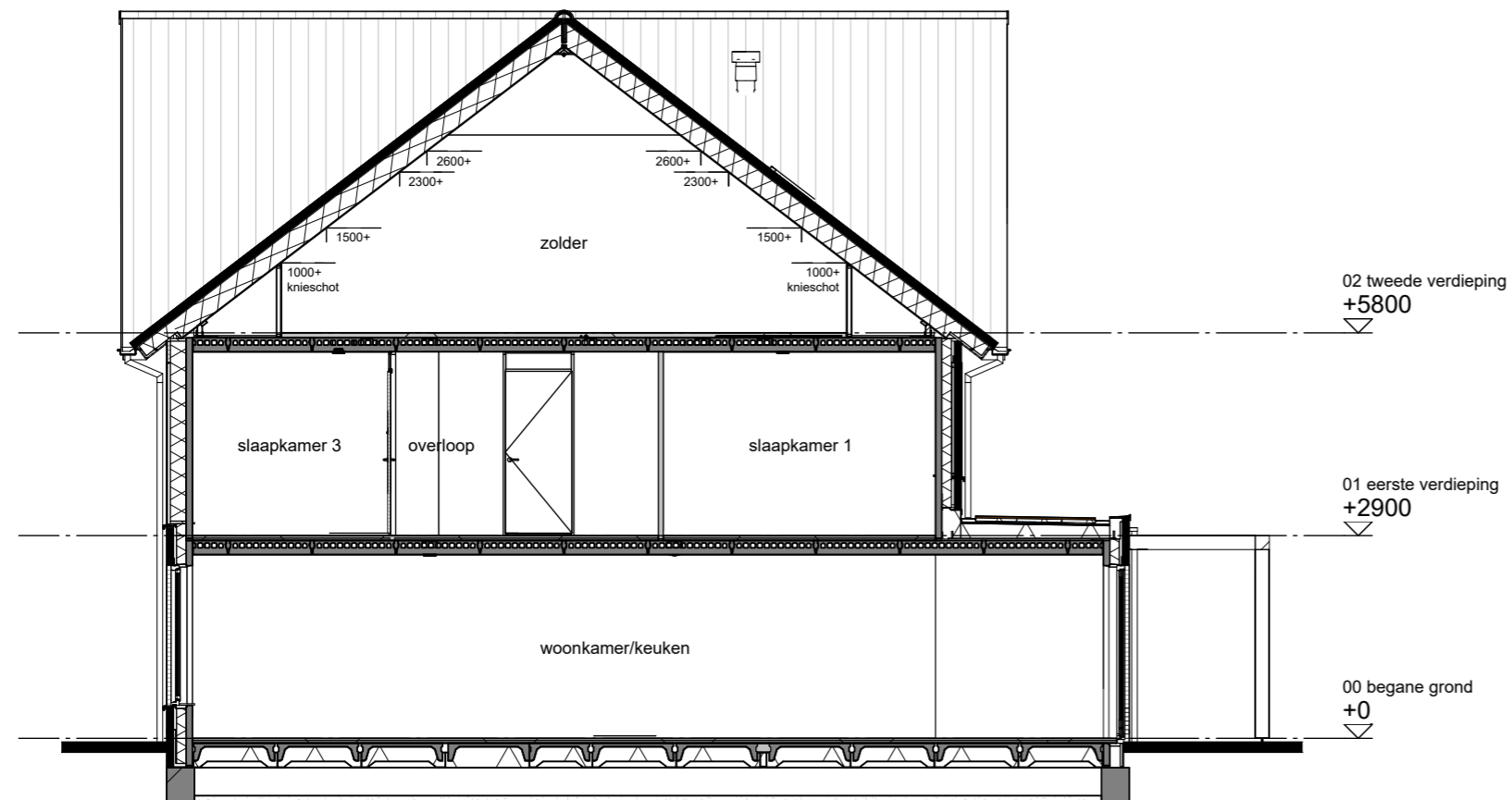

Doorsnede B-B

Type: E60
bnr: 7



Tekening: Doorsn. blok 4

Woningtype: E60D / E60

Bouwnummer: 6 / 7

Bladnummer: VT-04-00c

Bladformaat: A3

Schaal: 1 : 100

Datum: 21-04-2026

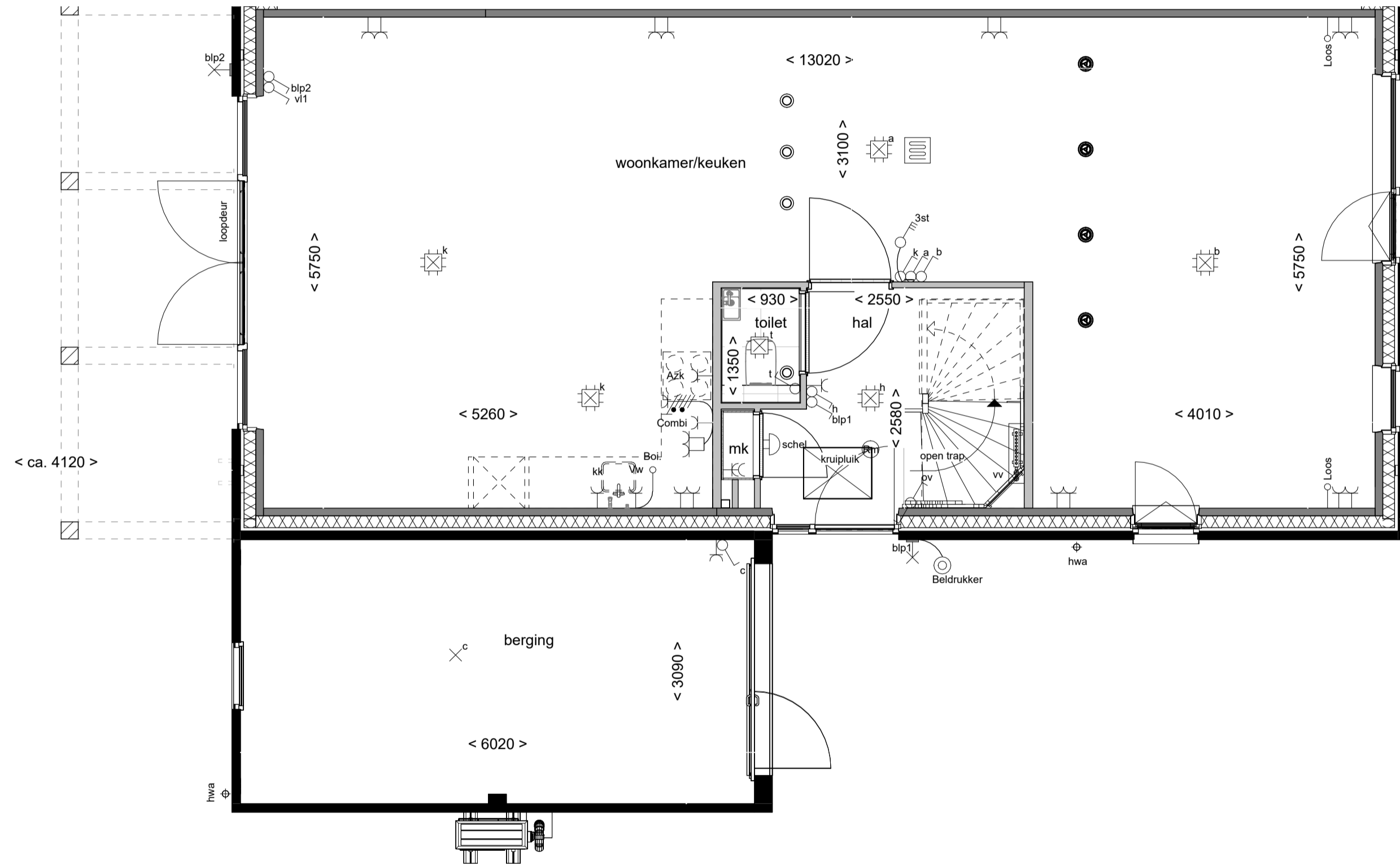
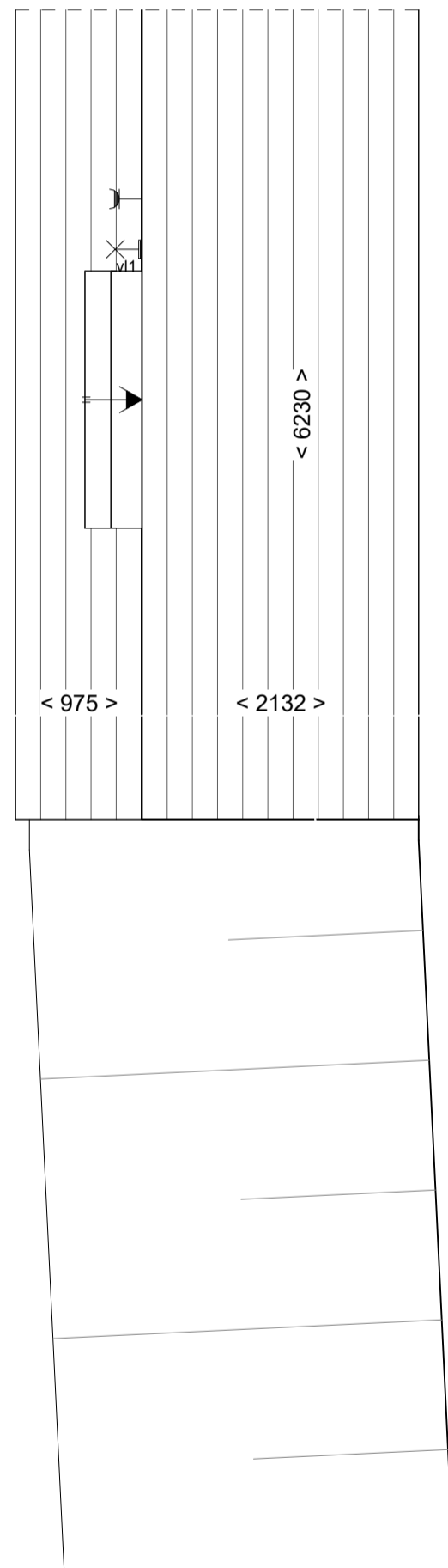

Tekening: **Begane grond**
 Woningtype: **E60D**
 Bouwnummer: **6**
 Bladnummer: **VT-04-06a**
 Bladformaat: **A2**
 Schaal: **1 : 50**
 Datum: **21-04-2026**

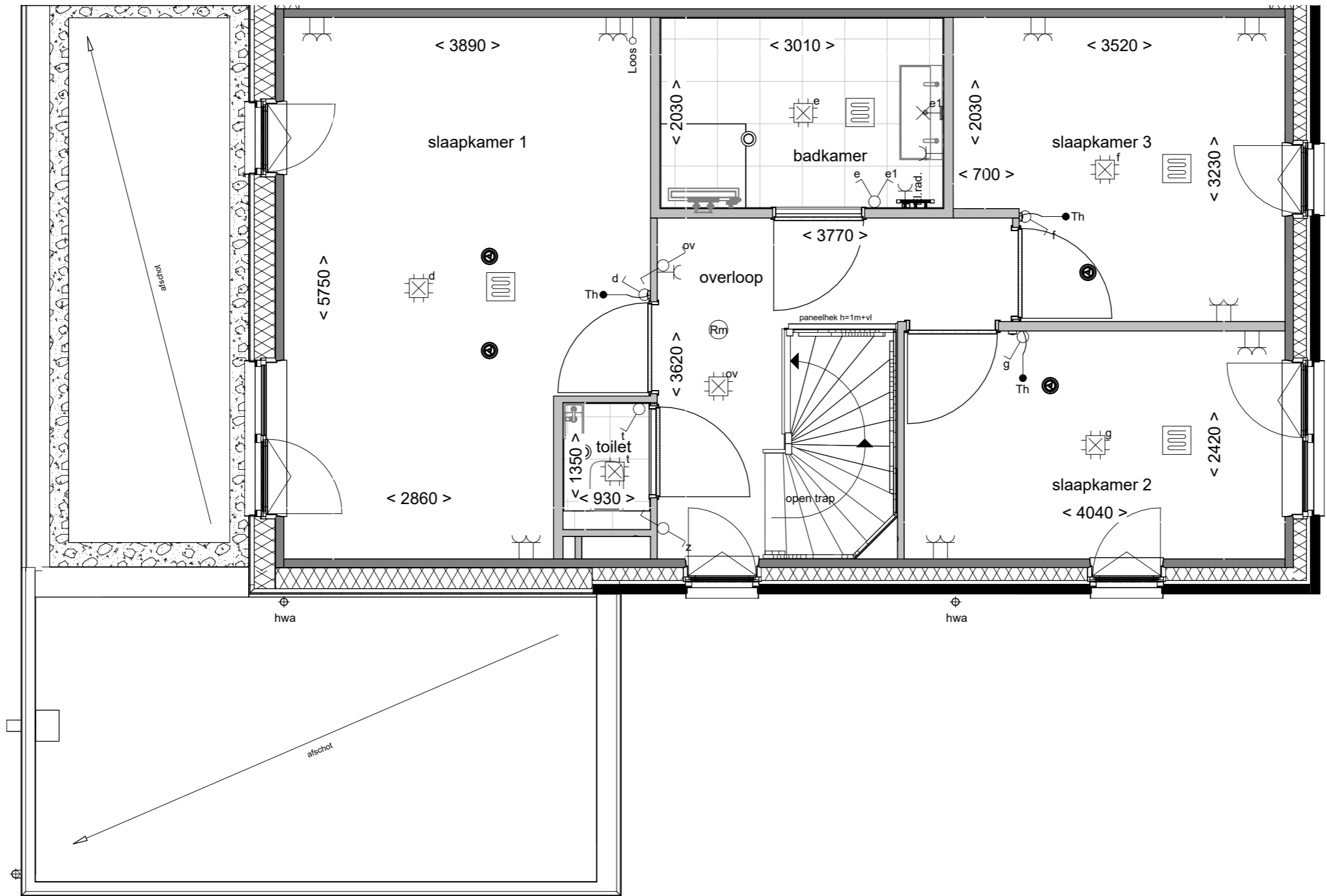

Tekening: **Eerste verdieping**
 Woningtype: **E60D**
 Bouwnummer: **6**
 Bladnummer: **VT-04-06b**
 Bladformaat: **A3**
 Schaal: **1 : 50**
 Datum: **21-04-2026**

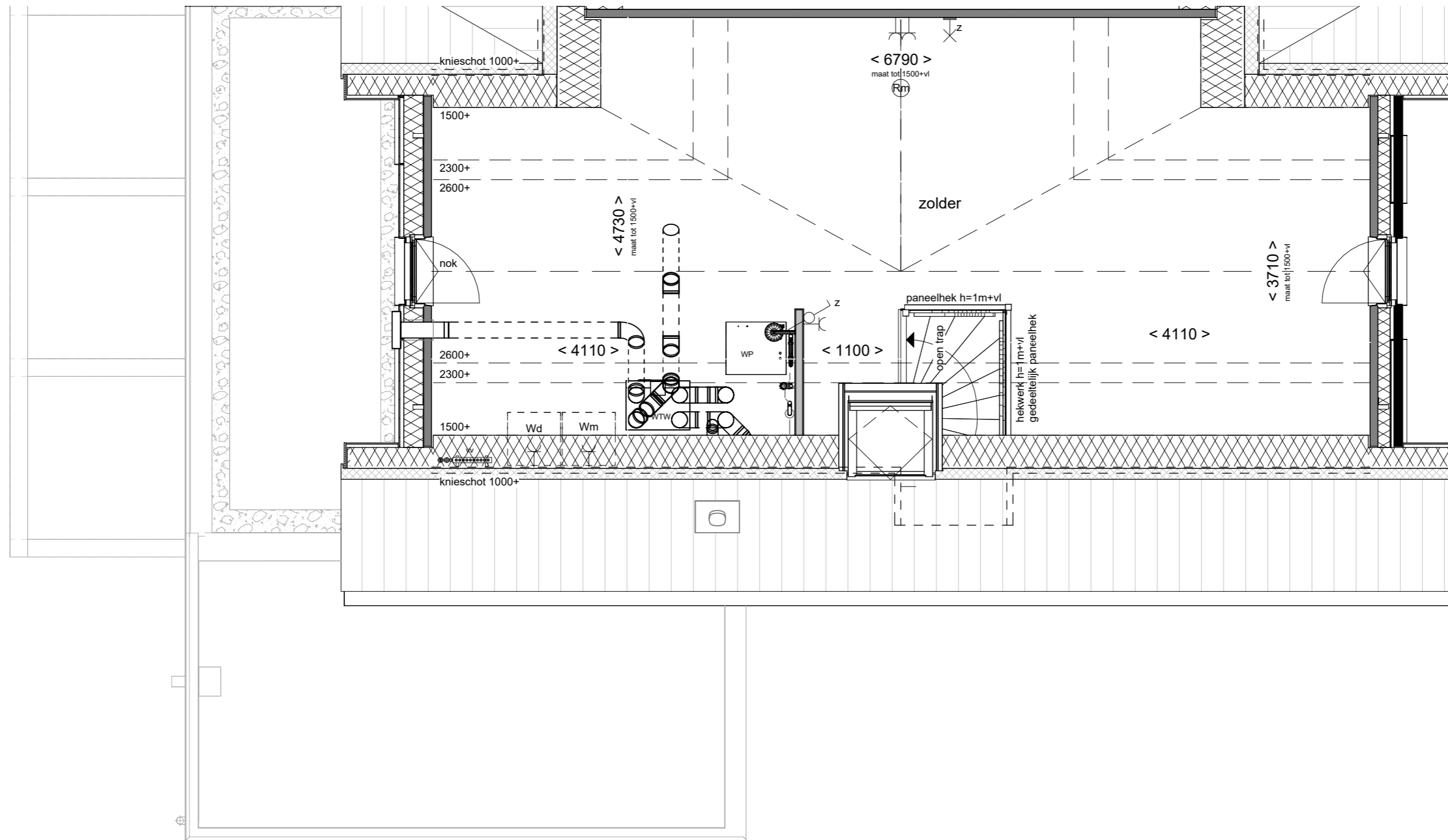

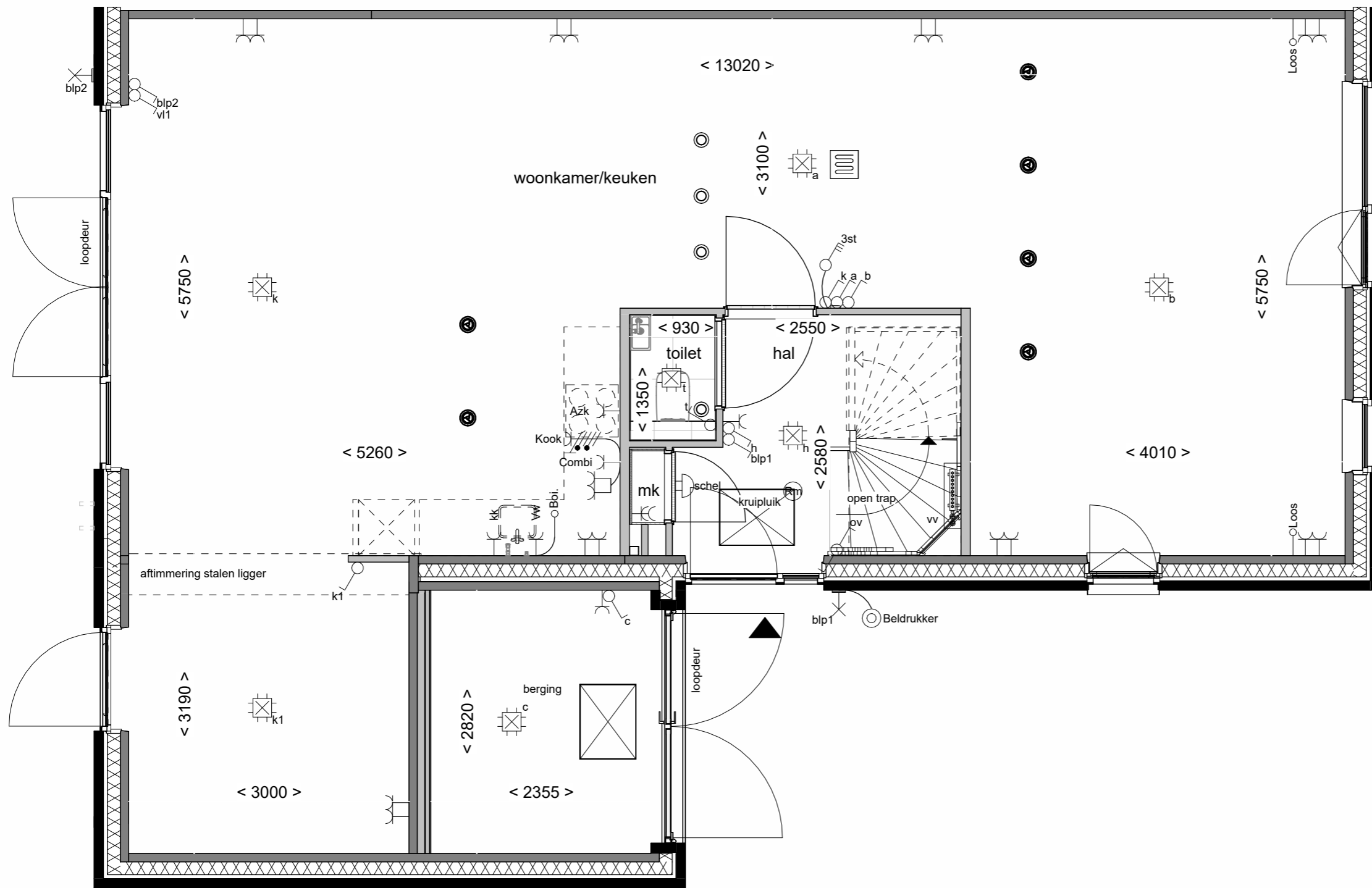

Begane grond

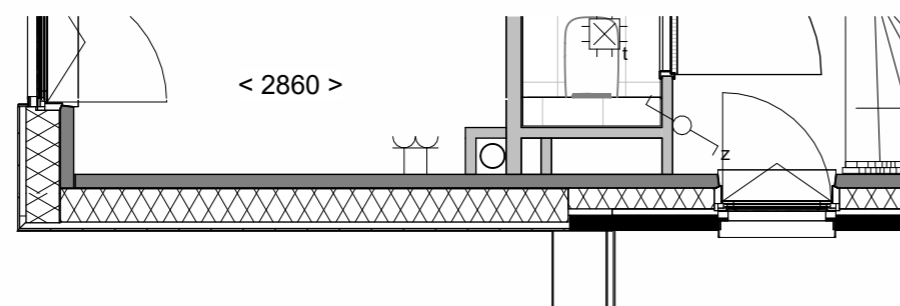

Eerste verdieping (extra schacht)



Achtergevel schaal 1:100



Samenvoegen
berging bij wnk

Tekening: E60

Woningtype: -

Bouwnummer: 1.A.E.14

Optienummer: A3

Schaal: 1:50 / 1:100

Datum: 21-04-2026

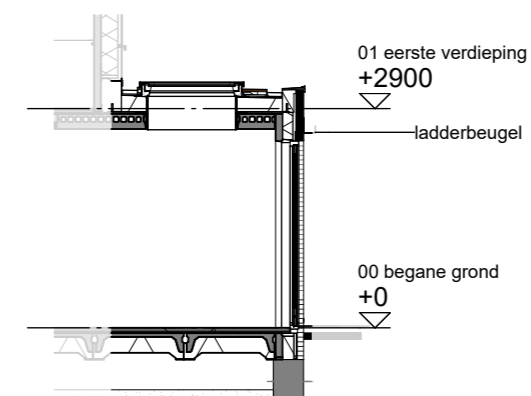
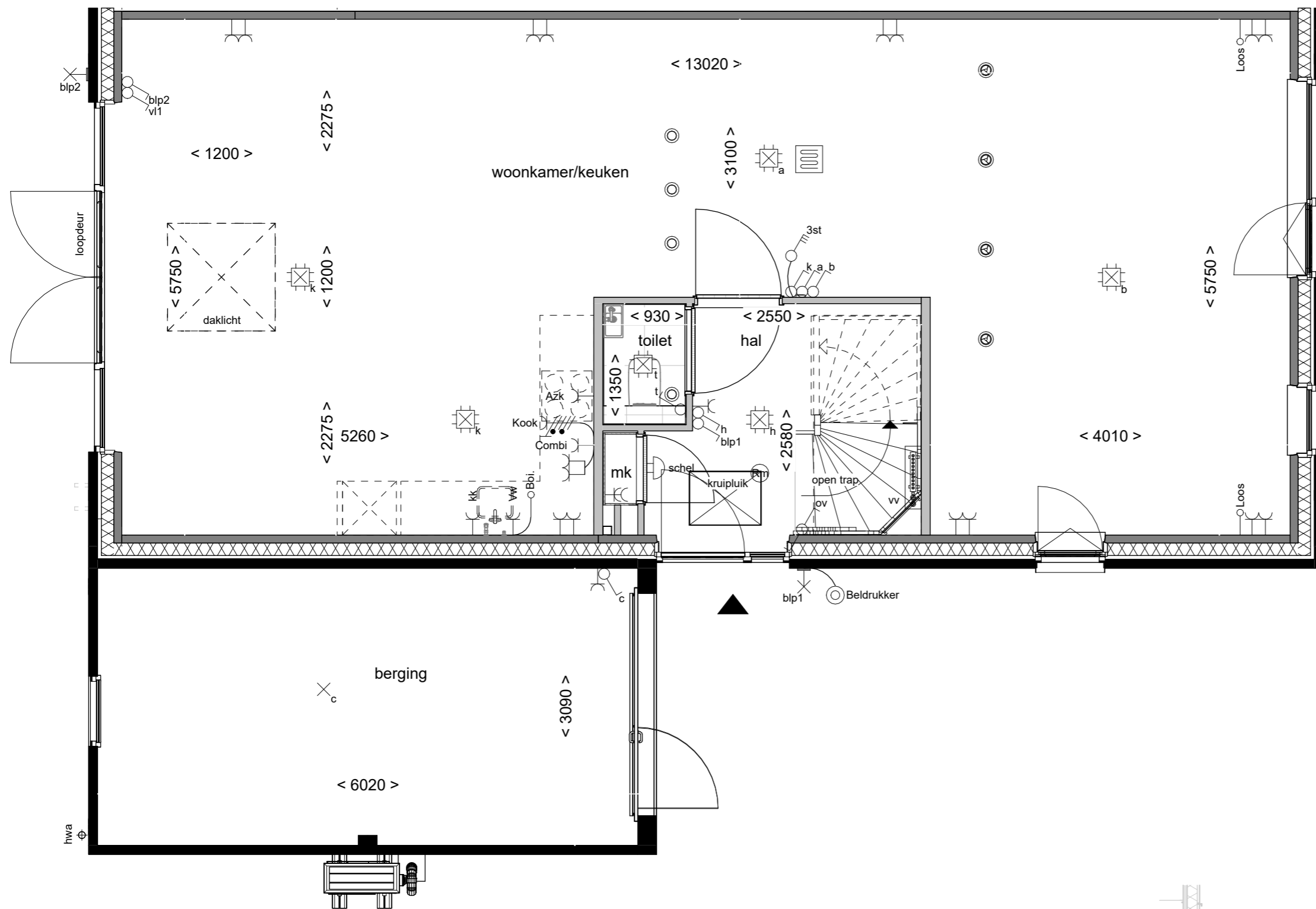

Doorsnede schaal 1:100



Lichtkoepel in
uitbouw 240cm

Tekening: -

Woningtype: E60

Bouwnummer: -

Optienummer: 1.B.X.10

Bladformaat: A3

Schaal: 1:50 / 1:100

Datum: 21-04-2026

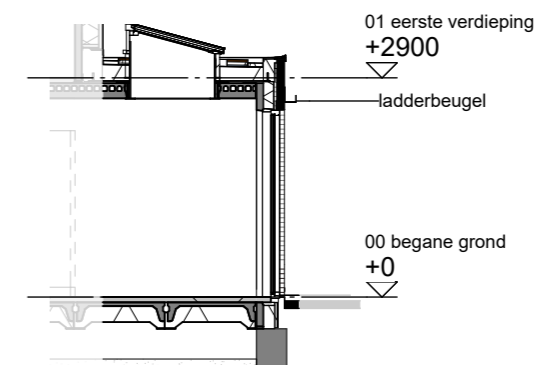
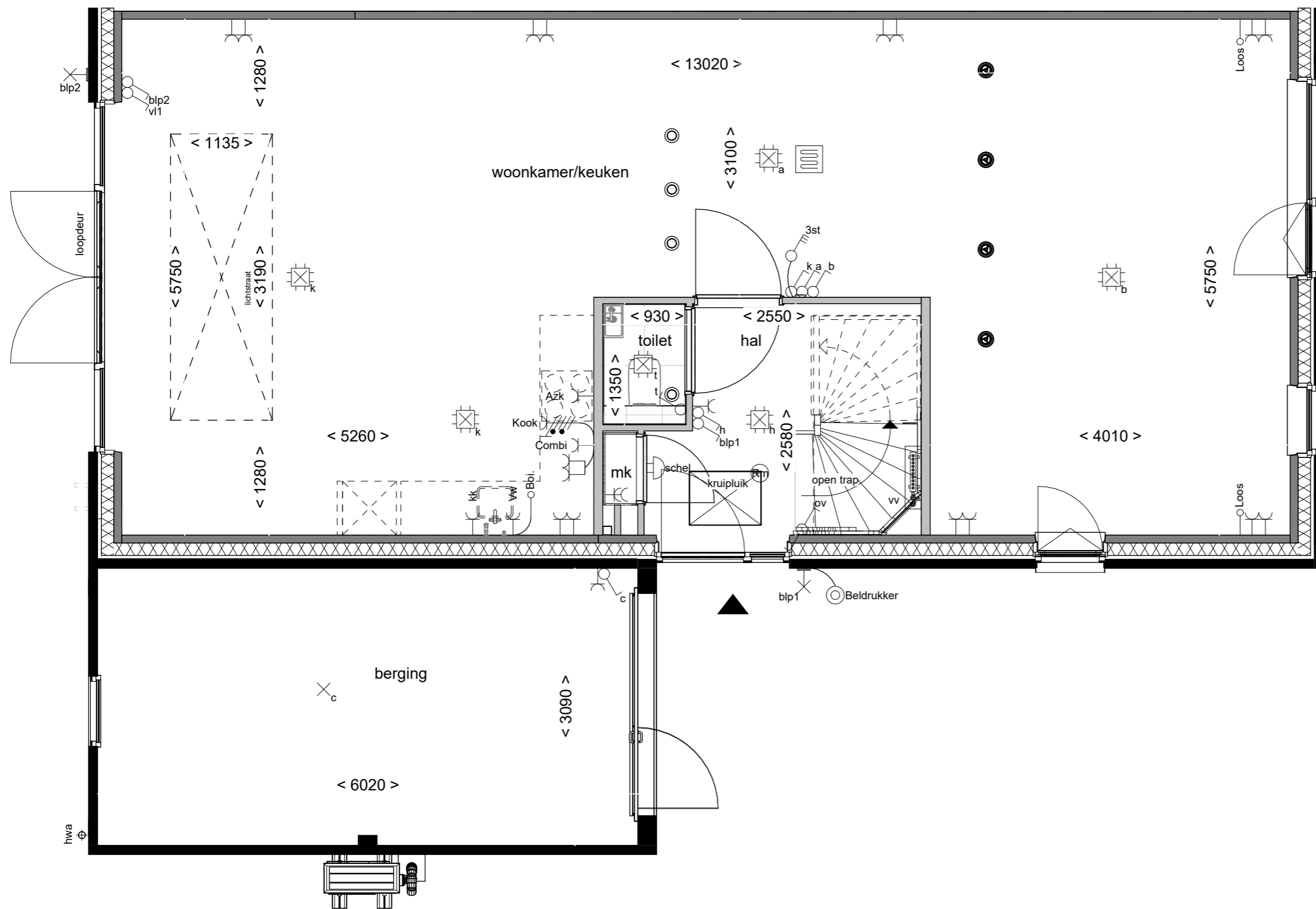

Doorsnede schaal 1:100



Lichtstraat in uitbouw
240cm

Tekening: 240cm

Woningtype: E60

Bouwnummer: -

Optienummer: 1.B.X.14

Bladformaat: A3

Schaal: 1:50 / 1:100

Datum: 21-04-2026

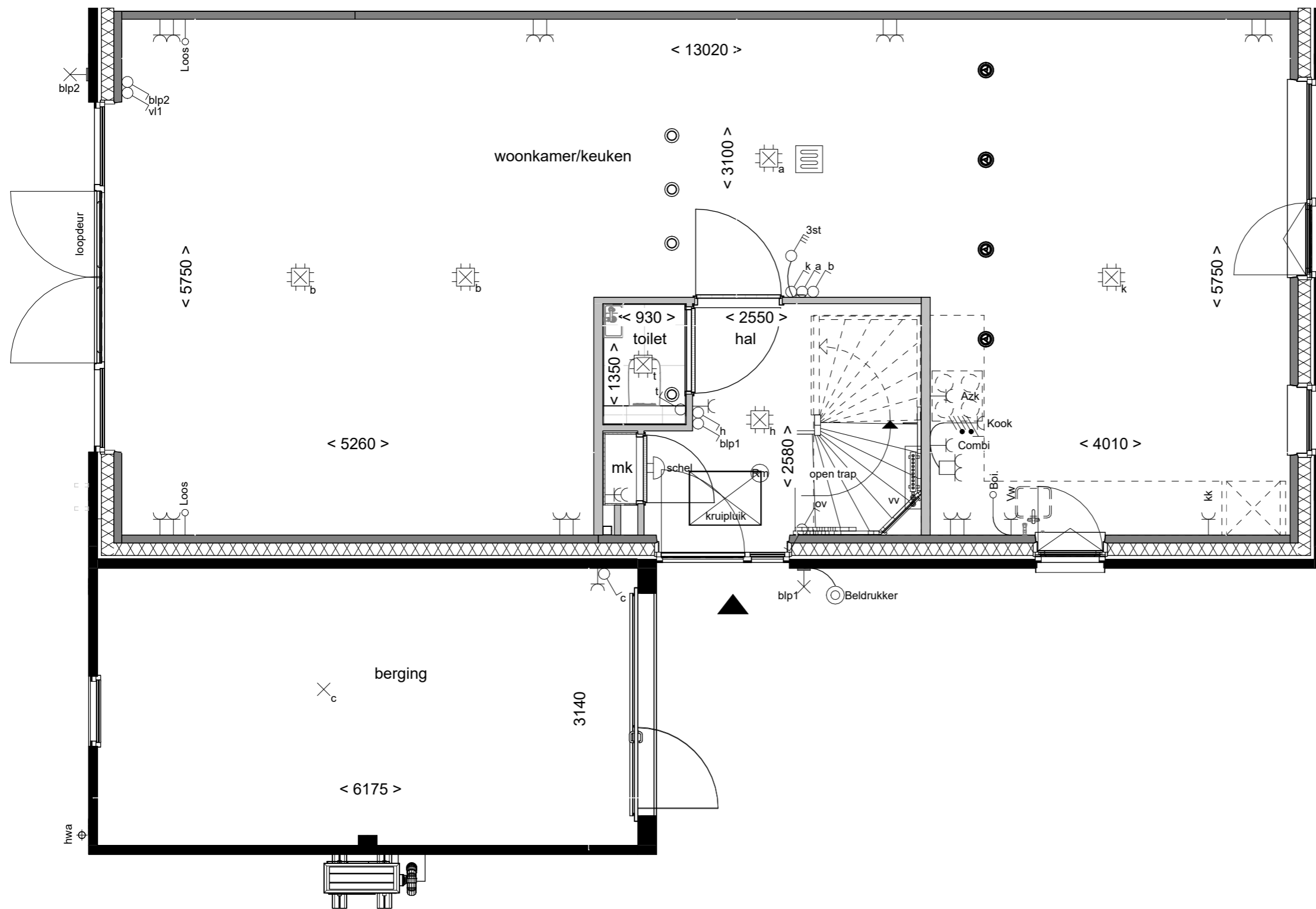

**Wonen aan
de Gantel**

Tekening: **Tuingericht wonen**

Woningtype: **E60**

Bouwnummer: **-**

Optienummer: **1.C.E.12**

Bladformaat: **A3**

Schaal: **1:50**

Datum: **21-04-2026**

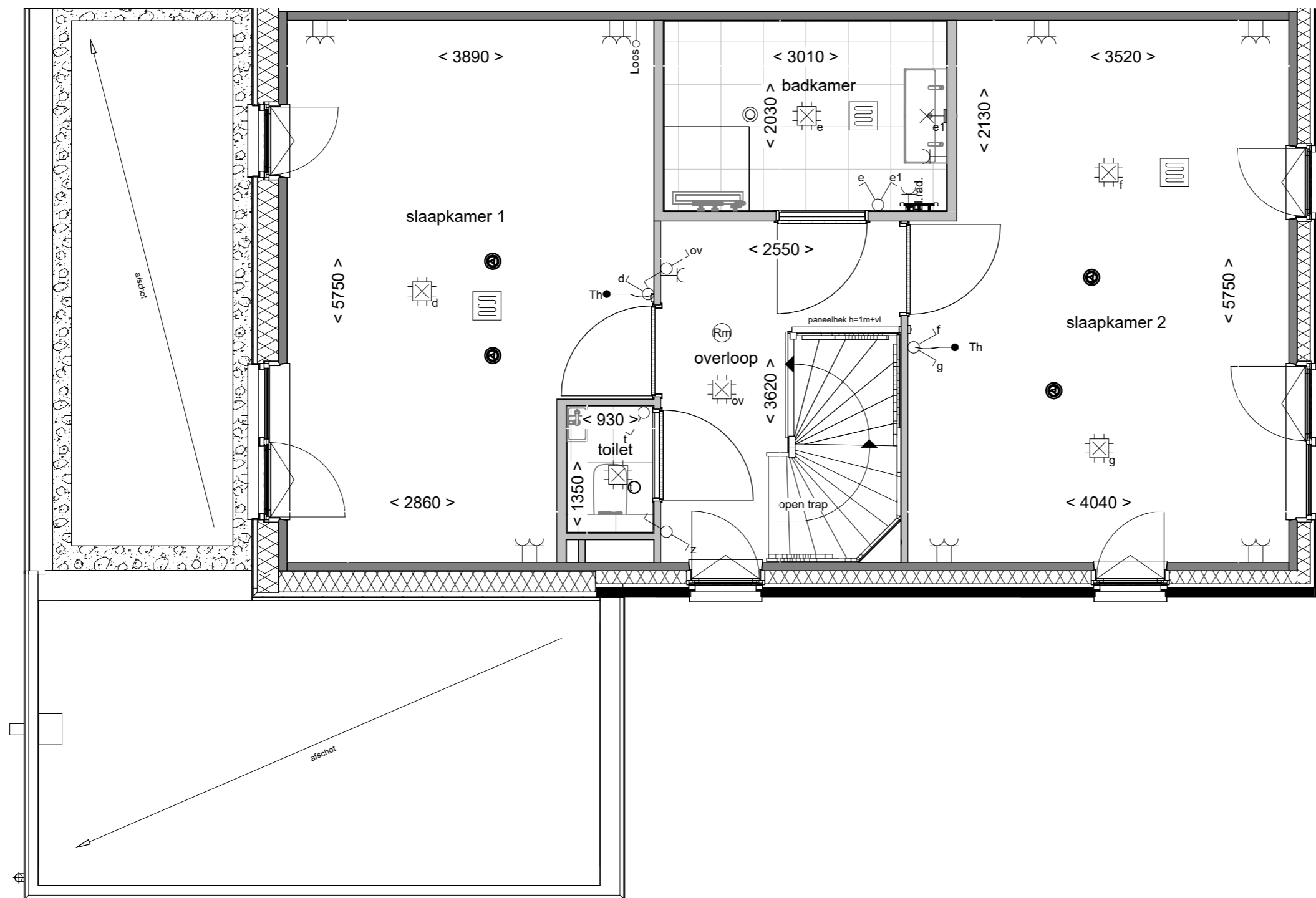

Samenvoegen
slaapkamers voor

Tekening:

Woningtype: E60

Bouwnummer: -

Optienummer: 1.C.E.30

Bladformaat: A3

Schaal: 1:50

Datum: 21-04-2026

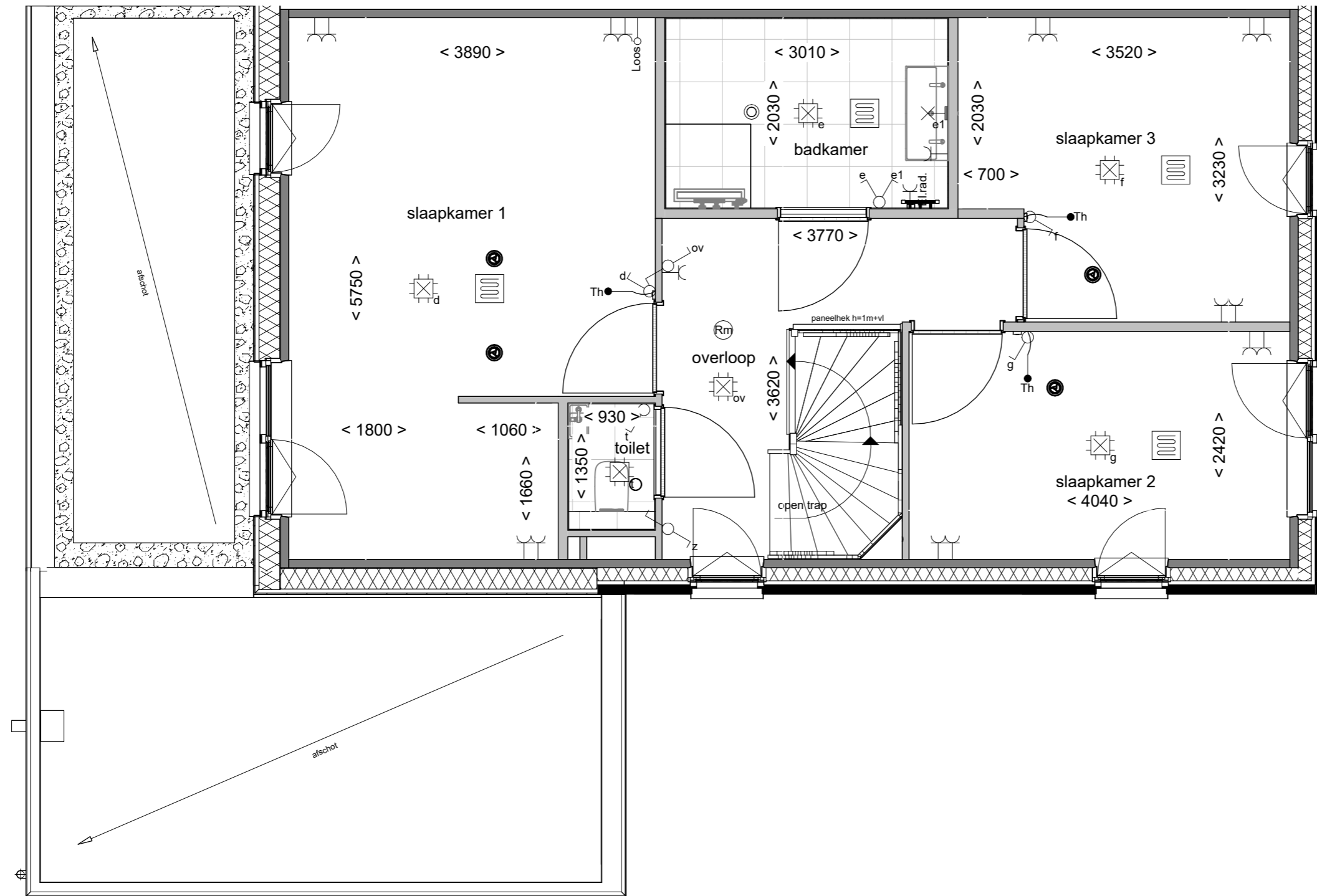

Inloopkast in
slaapkamer achter

Tekening:

Woningtype: E60

Bouwnummer: -

Optienummer: 1.C.E.32

Bladformaat: A3

Schaal: 1:50

Datum: 21-04-2026

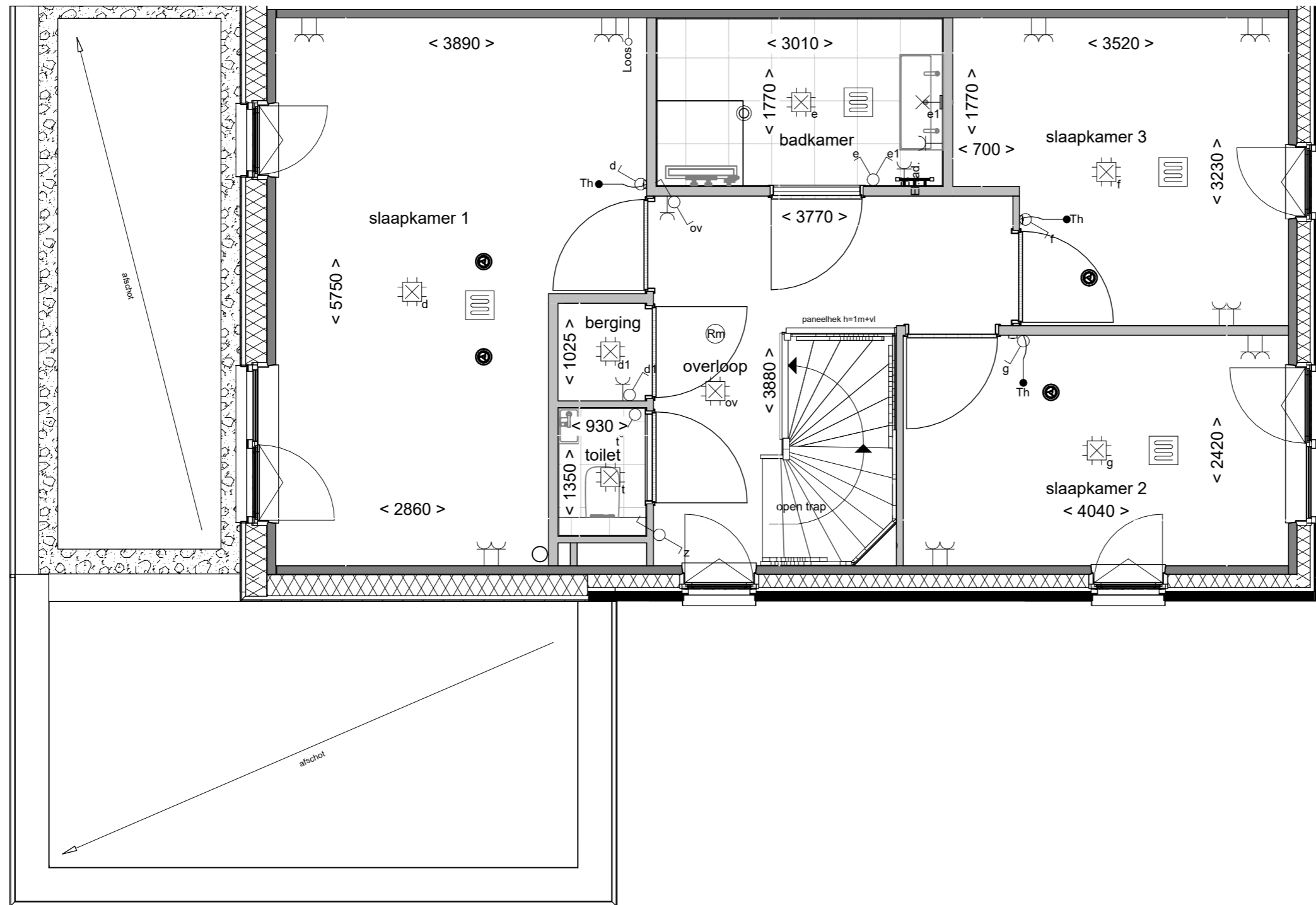

Vaste kast en compacte badk.

Tekening: **Vaste kast en compacte badk.**

Woningtype: **E60**

Bouwnummer: **-**

Optienummer: **1.C.E.34**

Bladformaat: **A3**

Schaal: **1:50**

Datum: **21-04-2026**

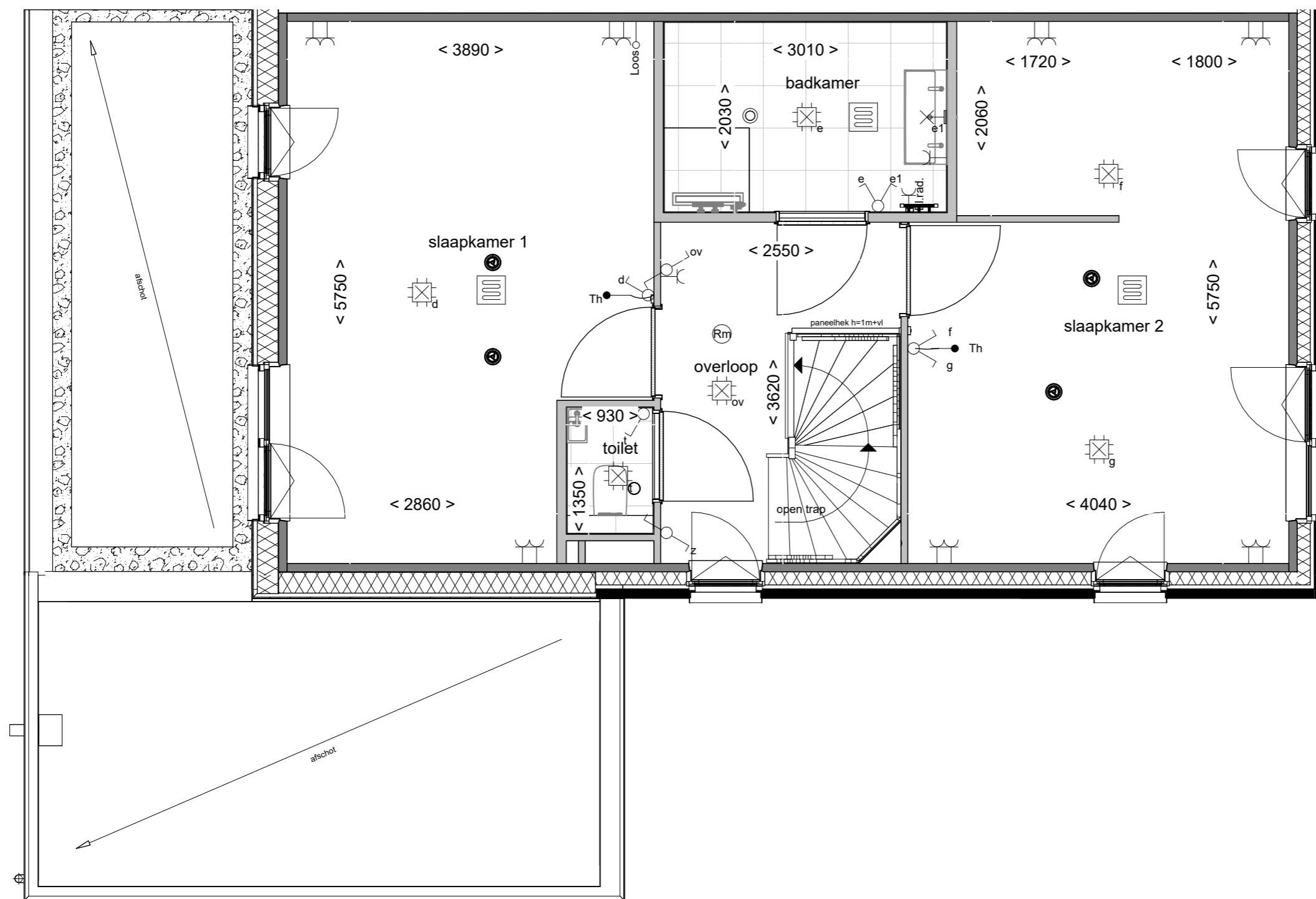

Samenvoegen slpk
voor met inloopkast

Tekening:

Woningtype: E60

Bouwnummer: -

Optienummer: 1.C.E.36

Bladformaat: A3

Schaal: 1:50

Datum: 21-04-2026

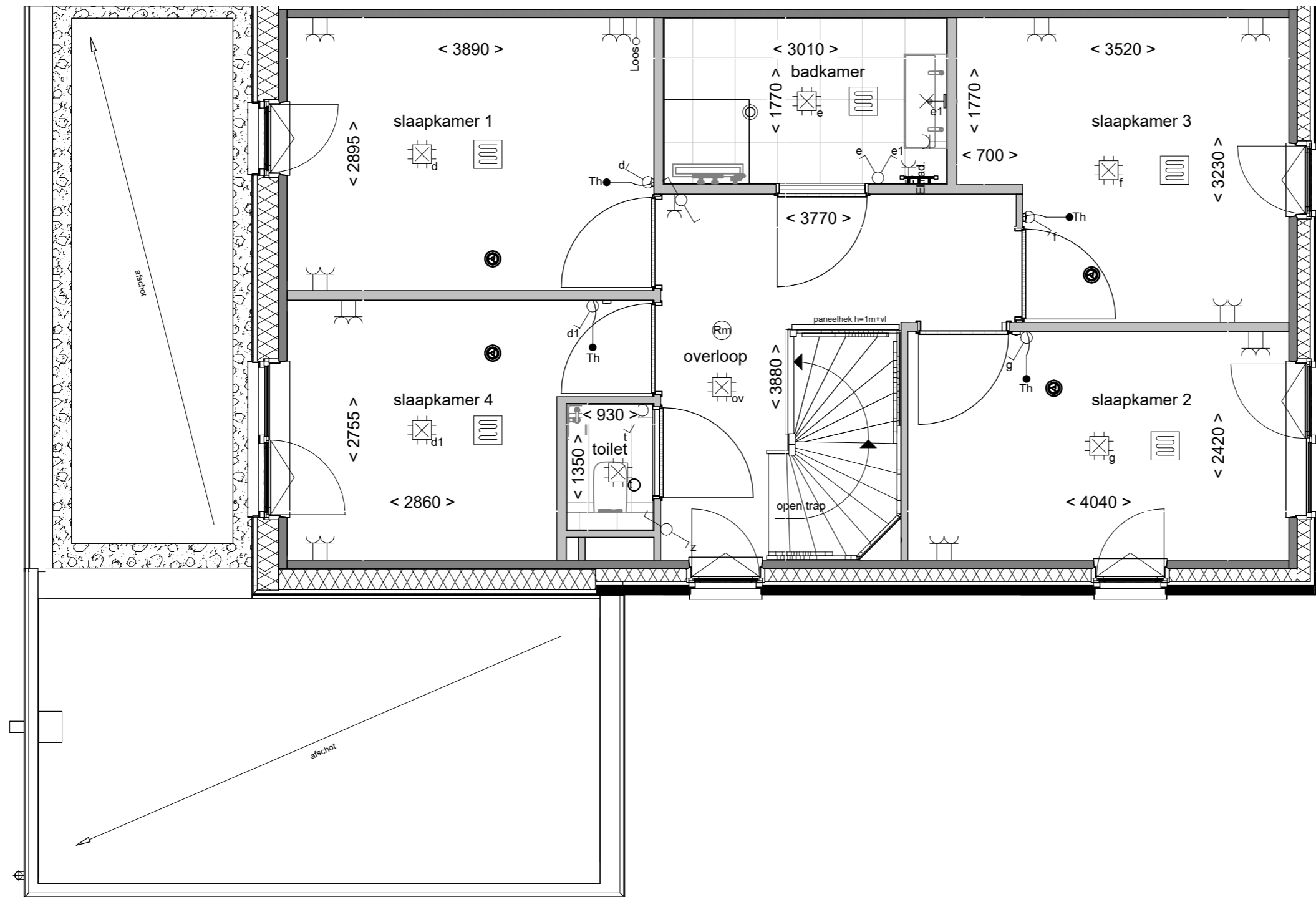

Compacte badk. met
4 slaapkamers

Tekening:

Woningtype: E60

Bouwnummer: -

Optienummer: 1.C.E.38

Bladformaat: A3

Schaal: 1:50

Datum: 21-04-2026

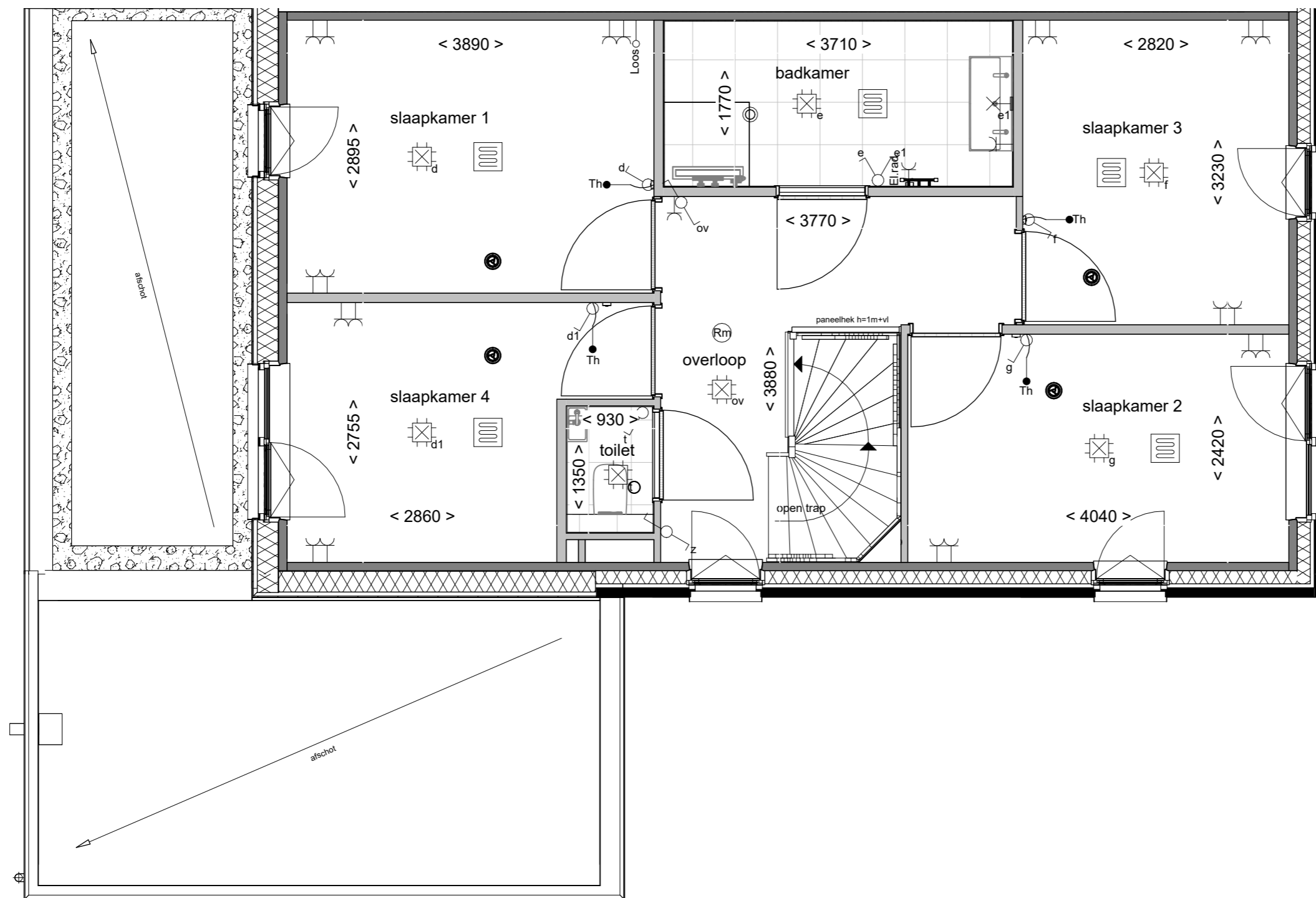

Verl. compacte badk.
met 4 slpk

Tekening: _____

Woningtype: E60 _____

Bouwnummer: - _____

Optienummer: 1.C.E.40 _____

Bladformaat: A3 _____

Schaal: 1:50 _____

Datum: 21-04-2026 _____

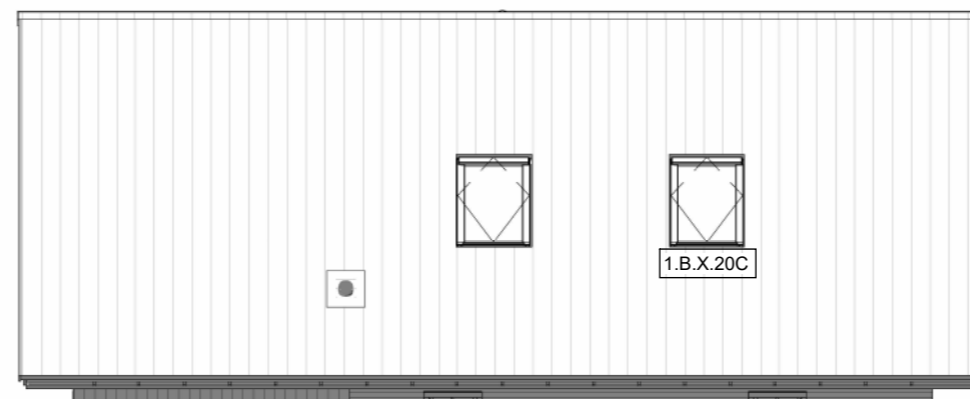
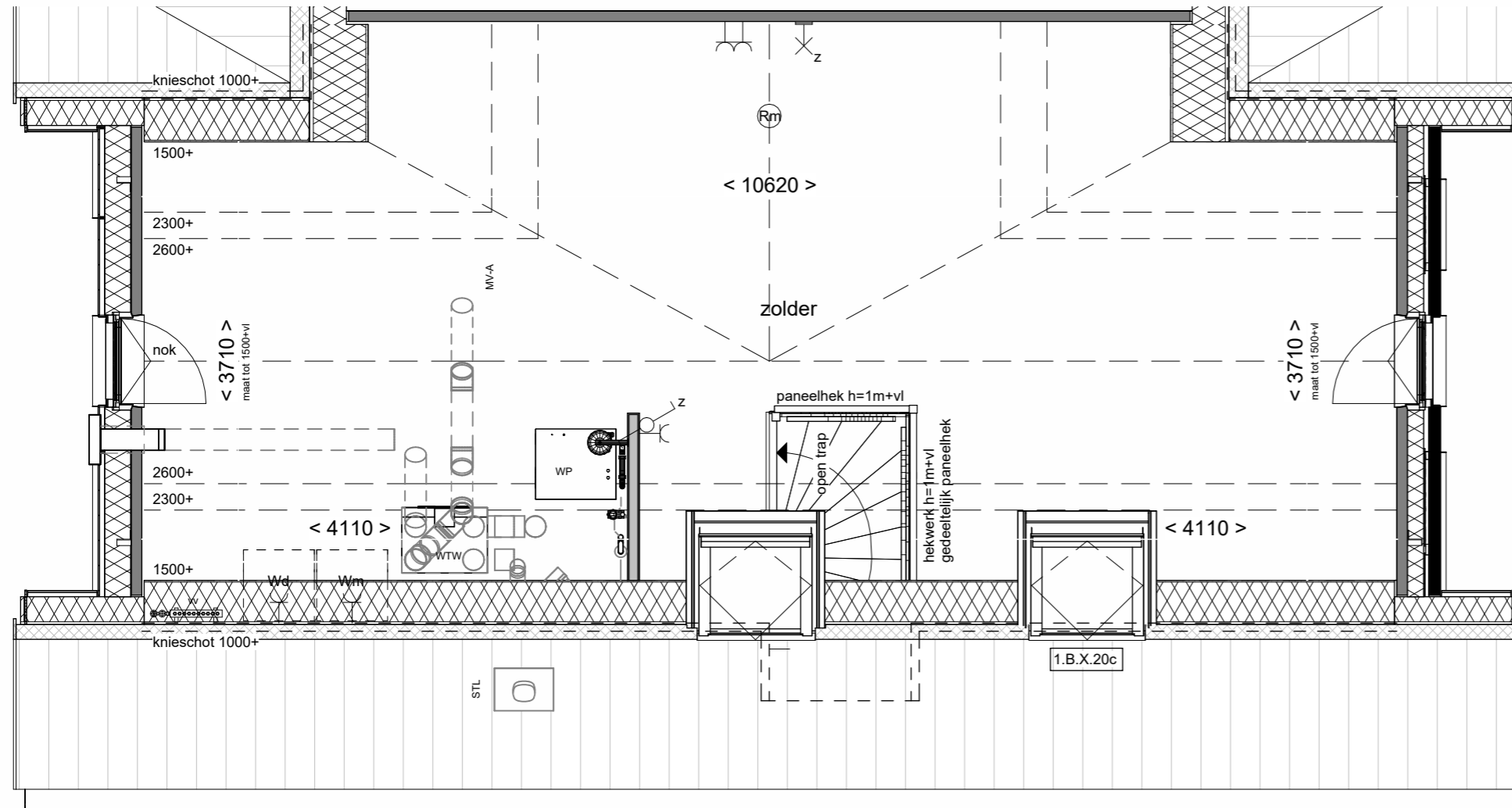

Linkerzijgevel schaal 1:100

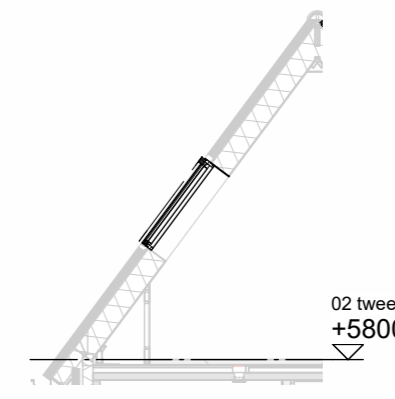

Doorsnede schaal 1:100



Tekening:	Dakraam zijgevel
Woningtype:	E60-D
Bouwnummer:	-
Optienummer:	1.B.X.20
Bladformaat:	A3
Schaal:	1:50 / 1:100
Datum:	21-04-2026

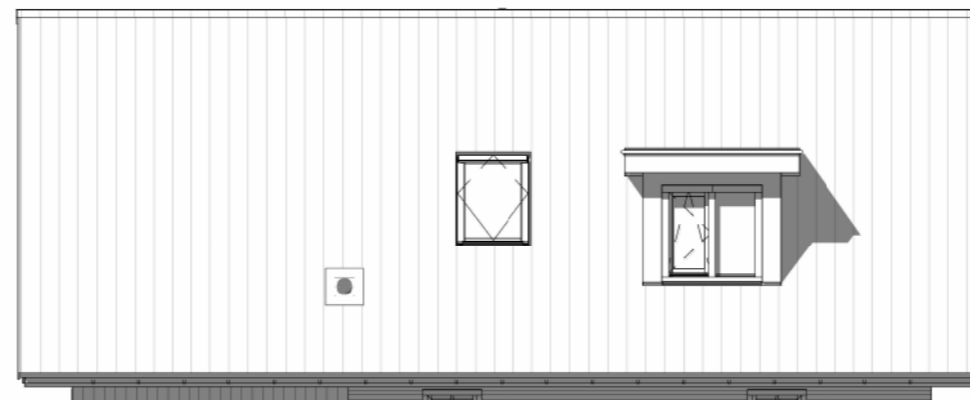
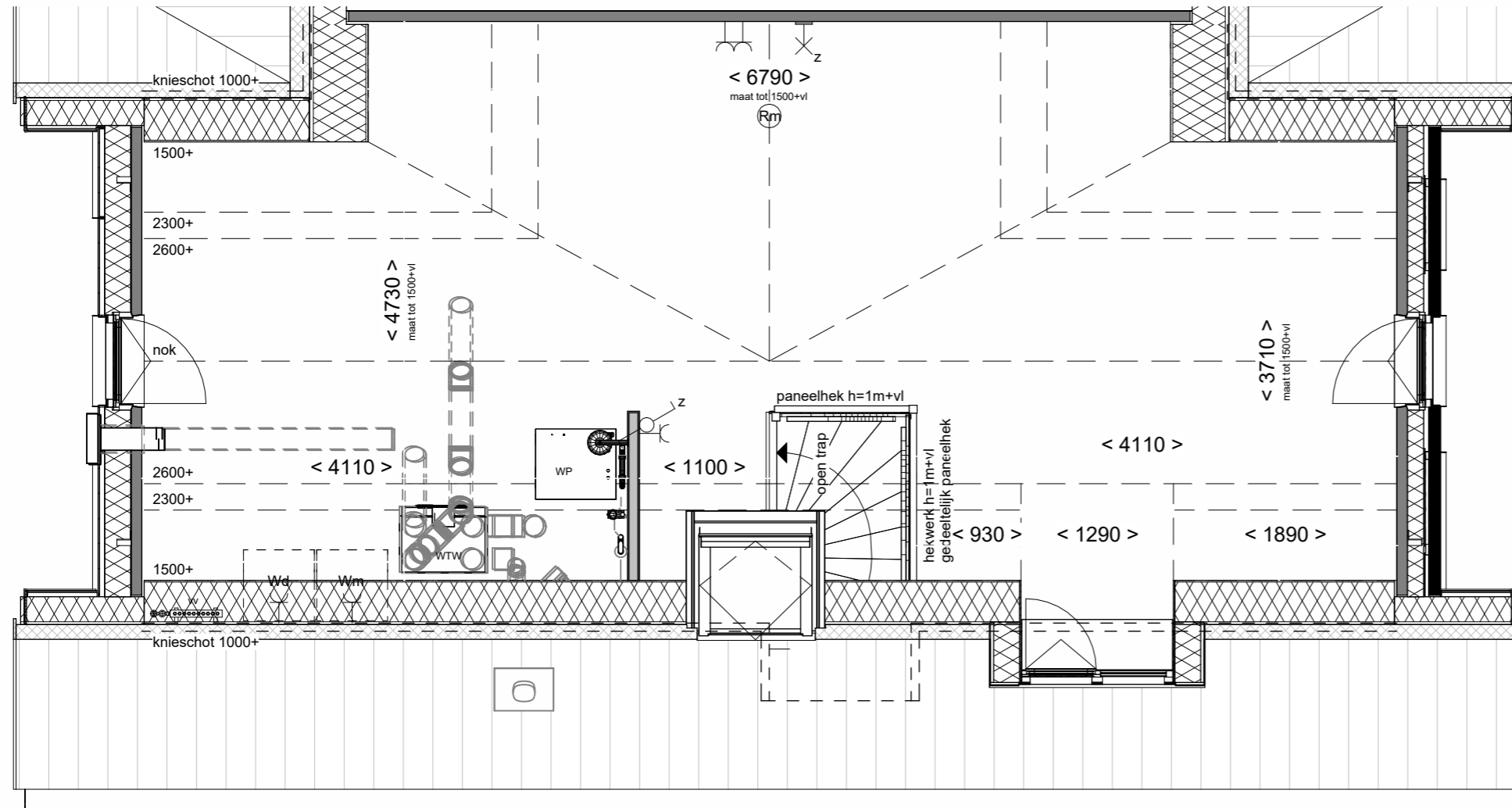

Linkerzijgevel schaal 1:100

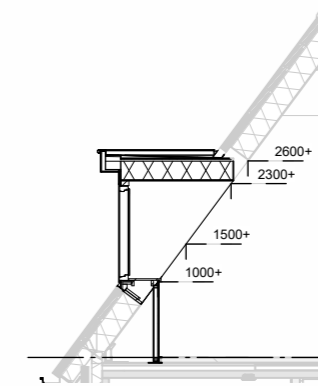

Doorsnede schaal 1:100



Dakkapel zijgevel
130cm

Tekening: 130cm

Woningtype: E60-D

Bouwnummer: -

Optienummer: 1.B.X.20

02 tweede verdieping
+5800
Bladformaat: A3

Schaal: 1:50 / 1:100

Datum: 21-04-2026

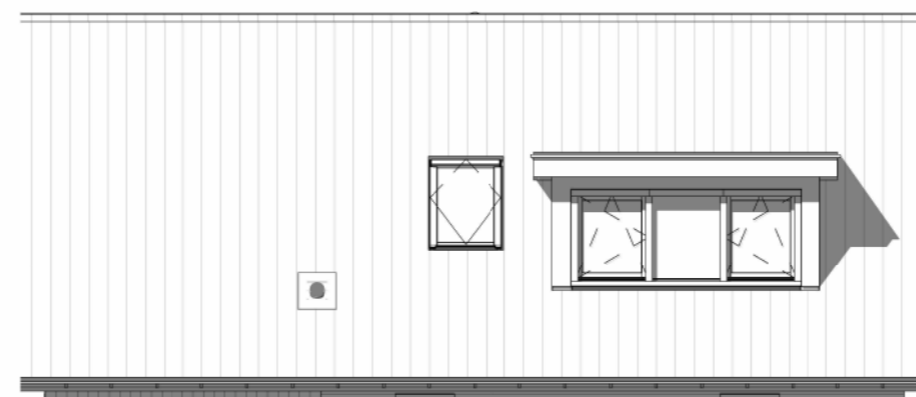
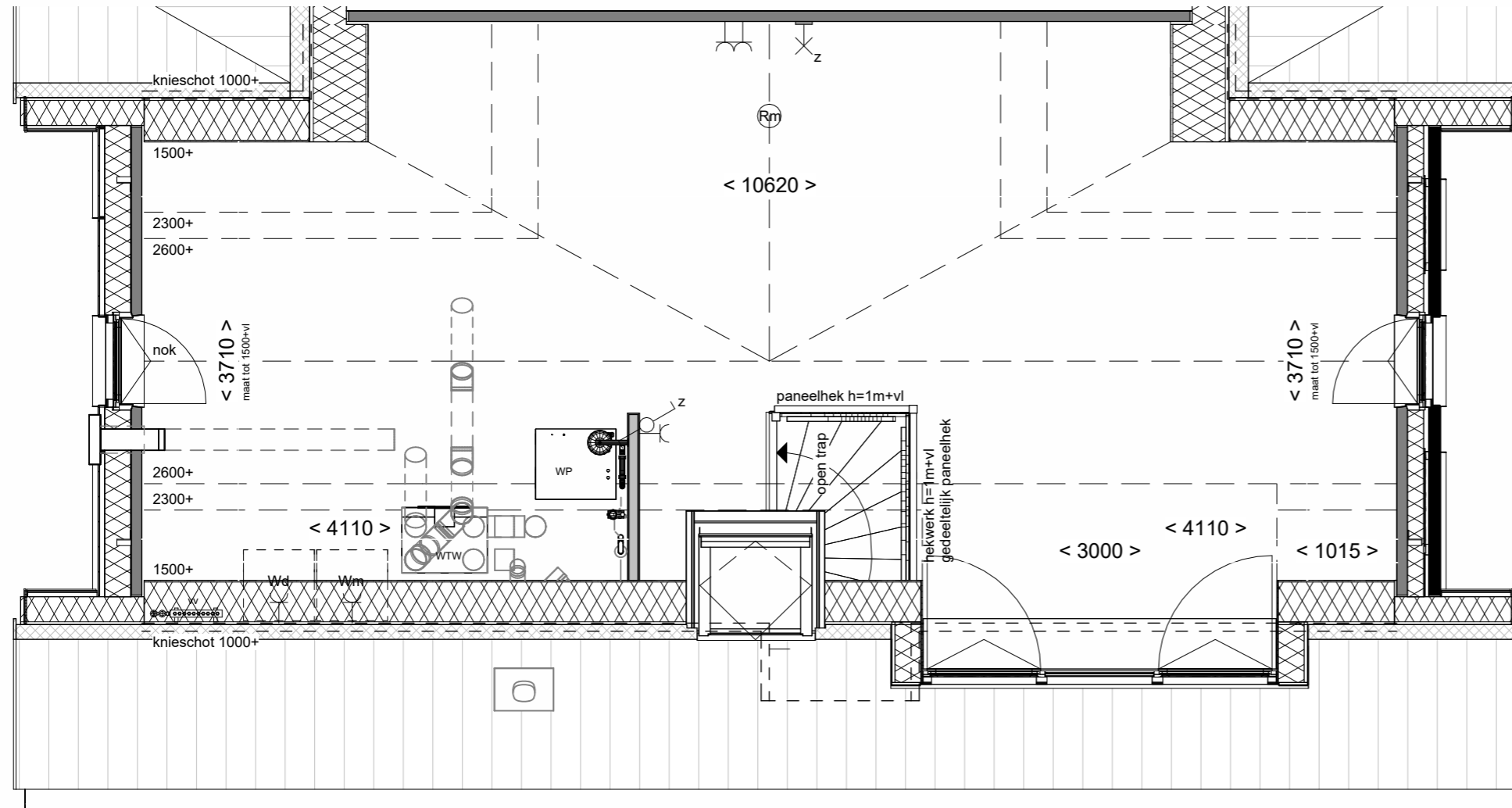

Linkerzijgevel schaal 1:100

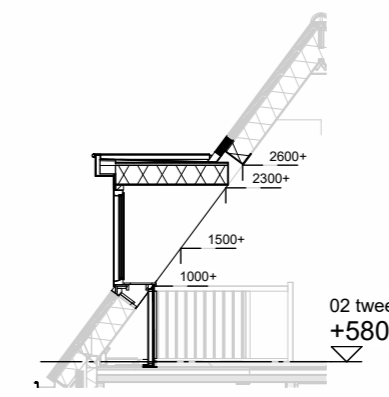

Doorsnede schaal 1:100



Dakkapel zijgevel
300cm

Tekening: 300cm

Woningtype: E60-D

Bouwnummer: -

Optienummer: 1.B.X.38

Bladformaat: A3

Schaal: 1:50 / 1:100

Datum: 21-04-2026

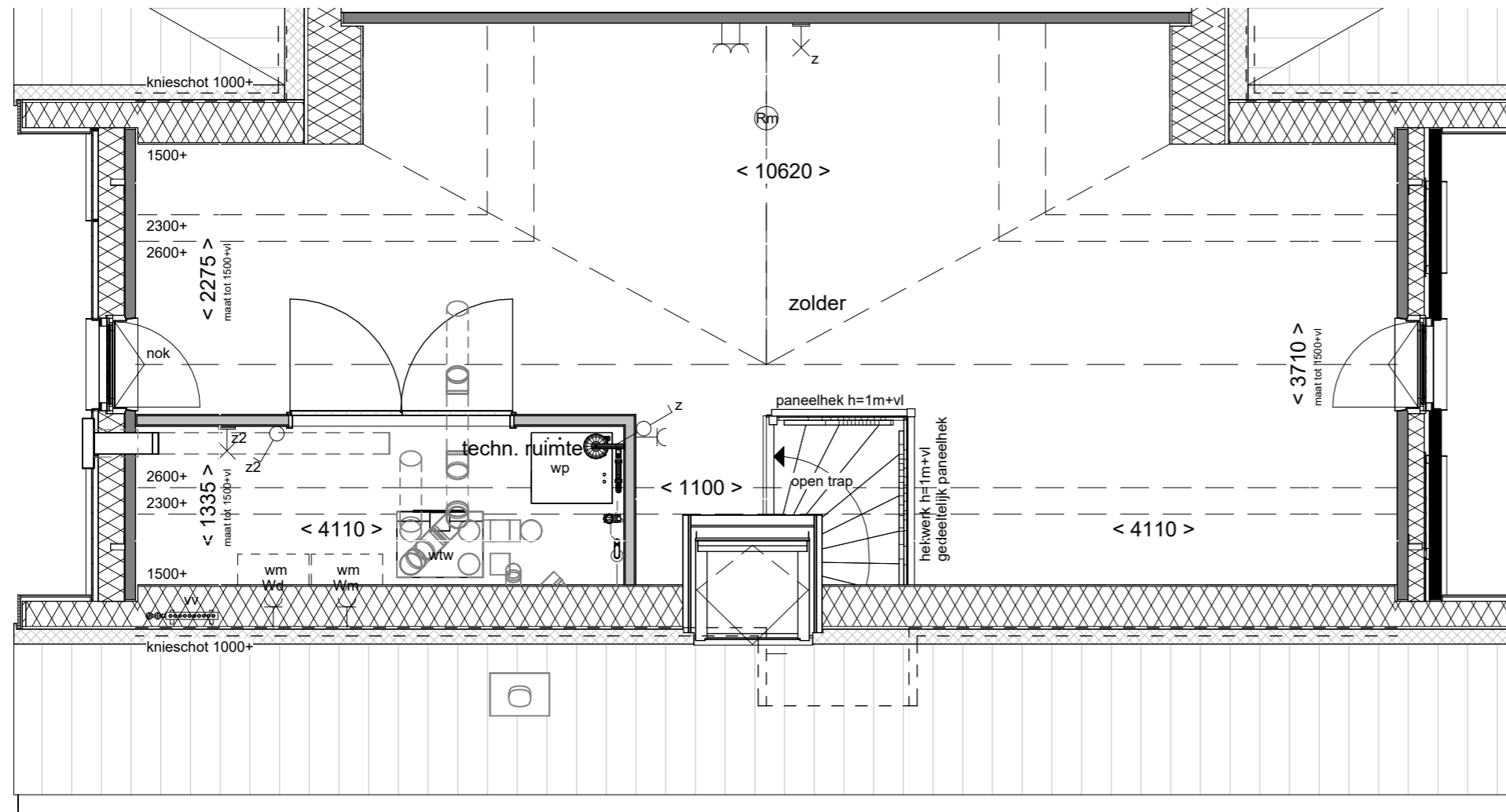

**Indeling met
techniekkast**

Tekening: **Indeling met techniekkast**

Woningtype: **E57-D**

Bouwnummer: **-**

Optienummer: **1.C.E.70**

Bladformaat: **A3**

Schaal: **1:50**

Datum: **21-04-2026**

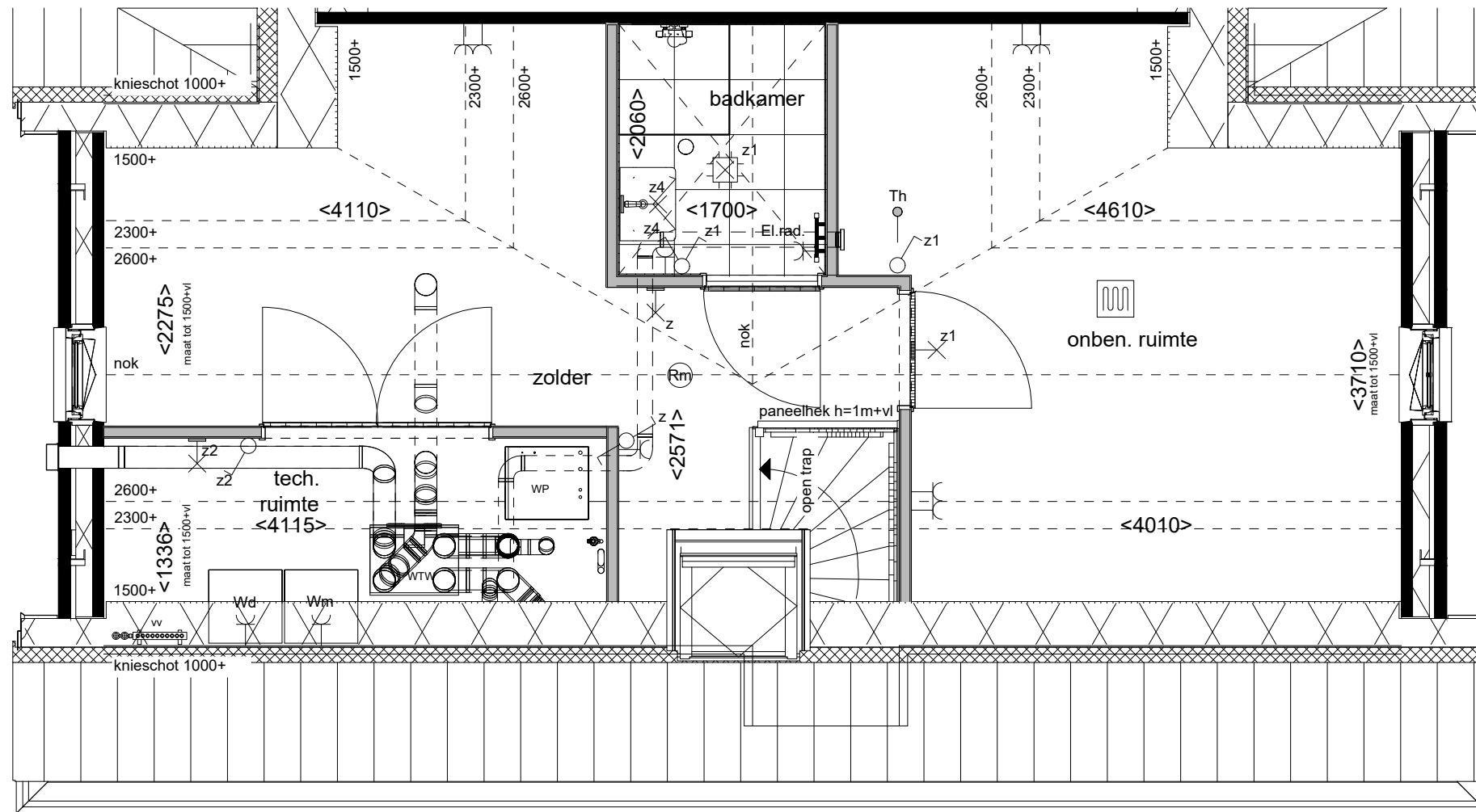

Indeling 2 ruimten en badkamer

Tekening: **Indeling 2 ruimten en badkamer**

Woningtype: **E60-D**

Bouwnummer: **-**

Optienummer: **1.C.E.82**

Bladformaat: **A3**

Schaal: **1:50**

Datum: **21-04-2026**

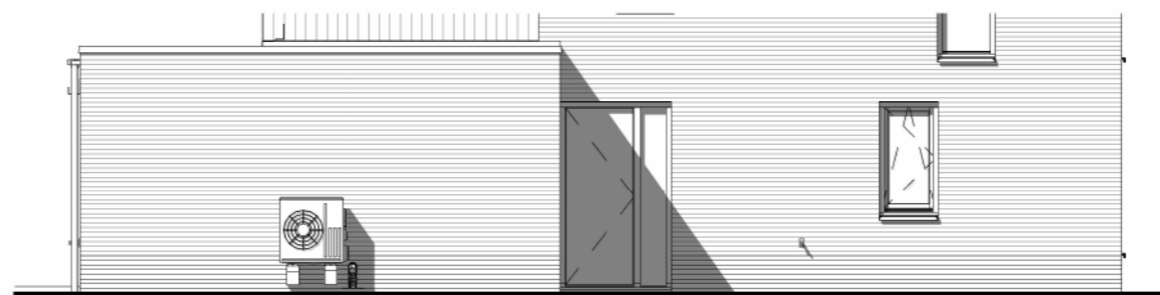
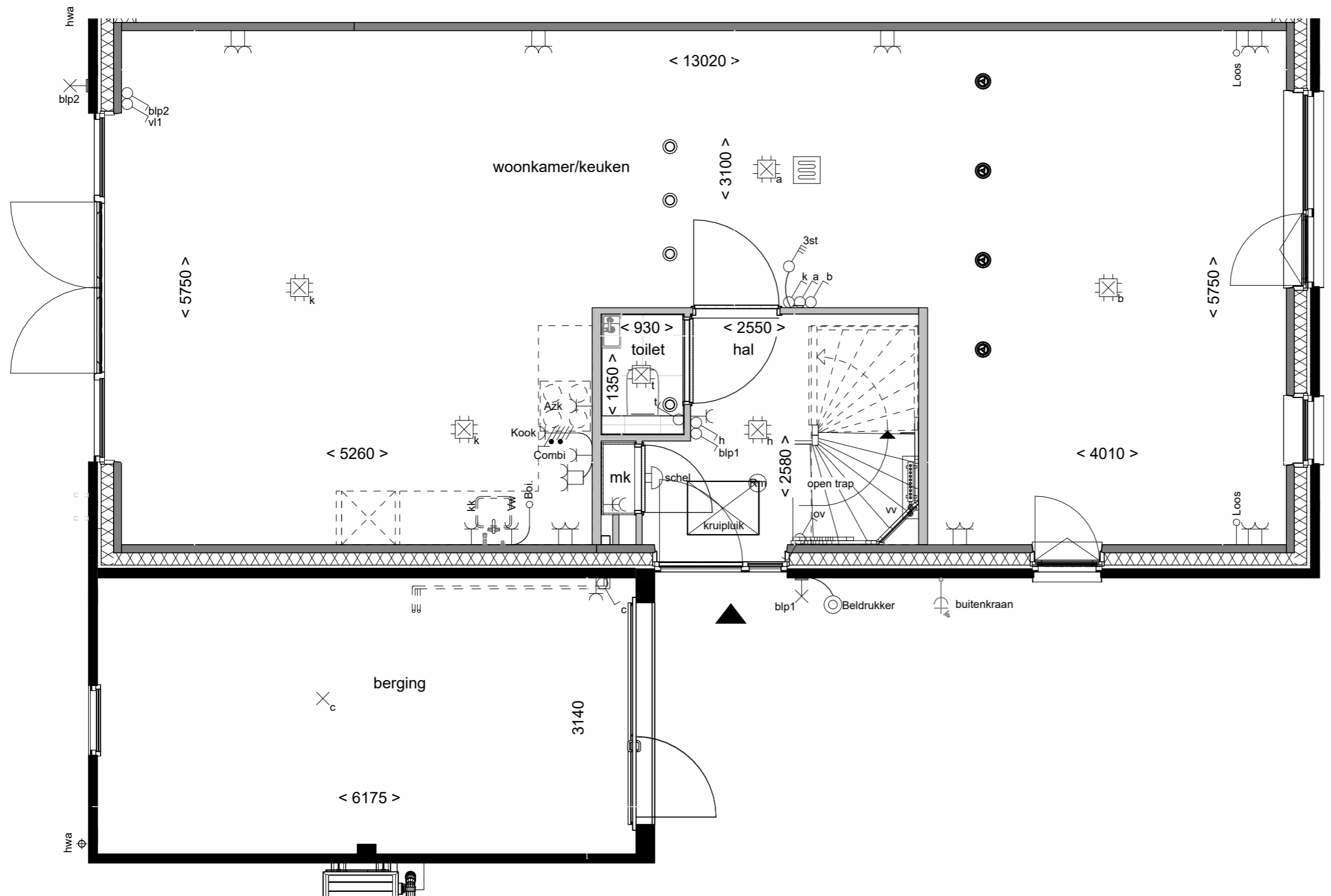

Linkerzijgevel schaal 1:100



vorstvrij buitenkraan
naast voordeur

Tekening:	vorstvrij buitenkraan naast voordeur
Woningtype:	E60
Bouwnummer:	02-07,10-13,16,17
Optienummer:	2.K.0.40
Bladformaat:	A3
Schaal:	1:50 / 1:100
Datum:	21-04-2026

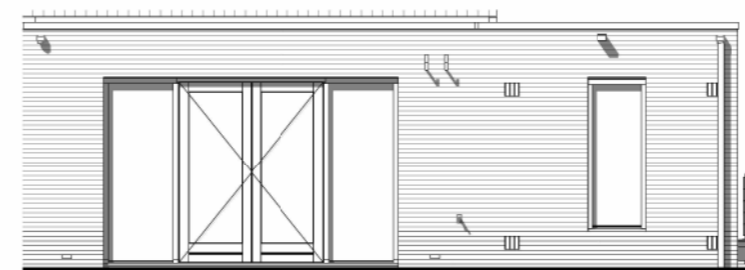
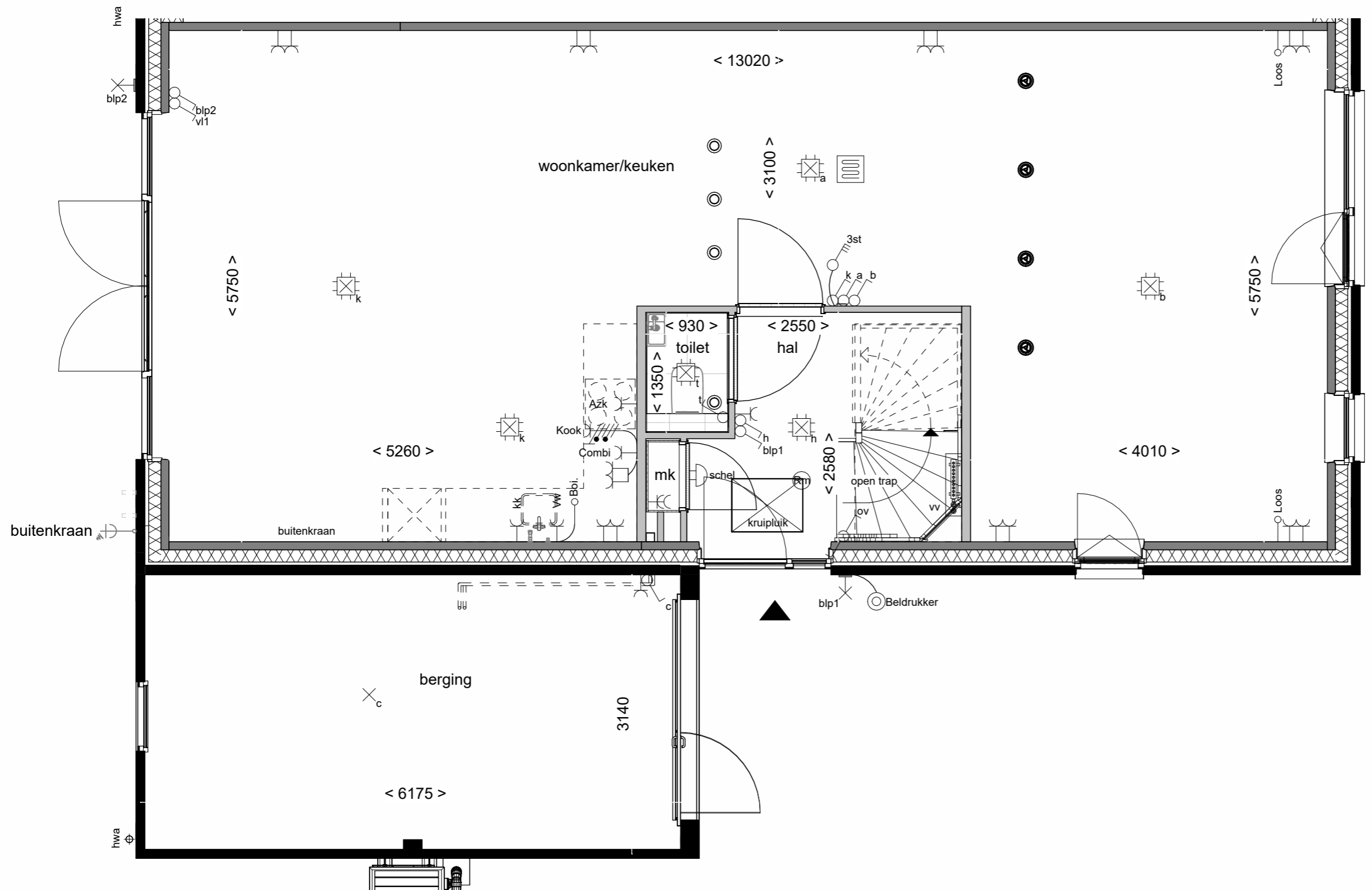

Achtergevel schaal 1:100



vorstvrij buitenkraan
achter

Tekening:	
Woningtype:	E60
Bouwnummer:	02-07,10-13,16,17
Optienummer:	2.K.0.44
Bladformaat:	A3
Schaal:	1:50 / 1:100
Datum:	21-04-2026

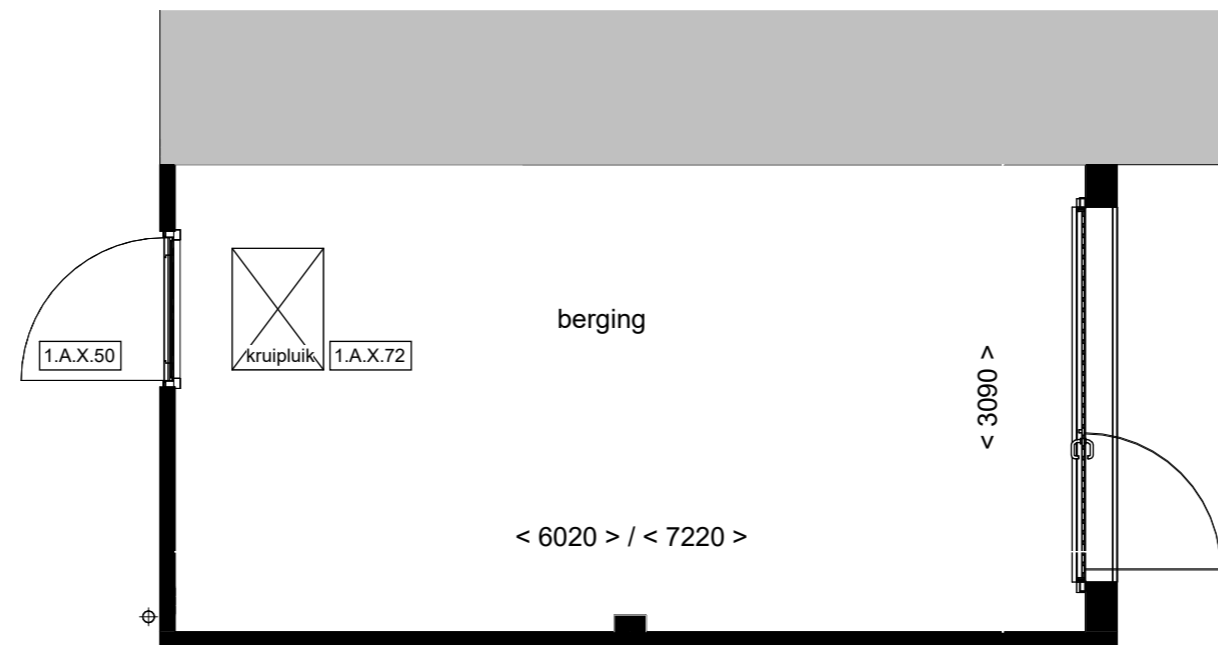

**Wonen aan
de Gantel**

Kruipluik in de
berging

Tekening:

Woningtype: E60/F60/F60+/F60D

Bouwnummer: 1 t/m 20

Optienummer: 1.A.X.50 / 1.A.X.72

Bladformaat: A3

Schaal: 1 : 50

Datum: 21-04-2026

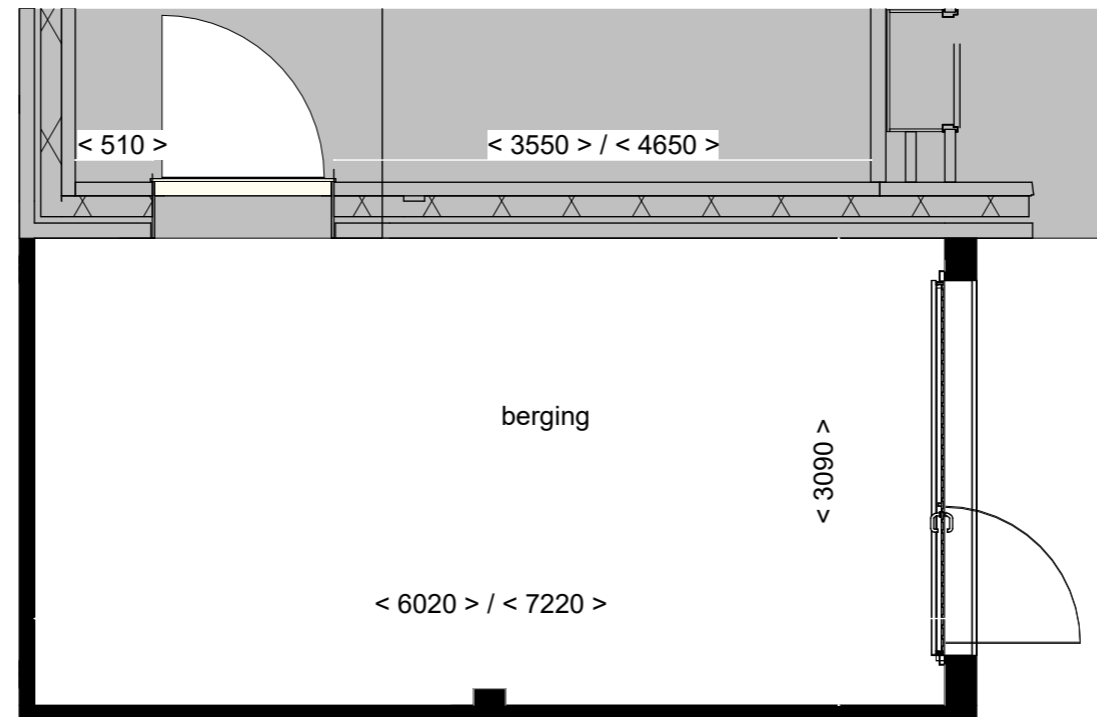

Tekening: Buitendeur tussen woning en berging

Woningtype: E60/F60/F60+

Bouwnummer: 1 t/m 19

Optienummer: 1.A.X.74 B

Bladformaat: A3

Schaal: 1 : 50

Datum: 21-04-2026

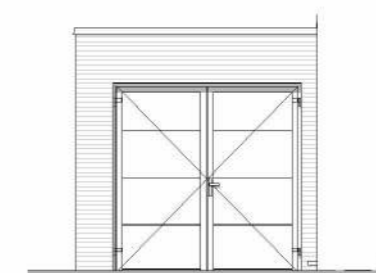
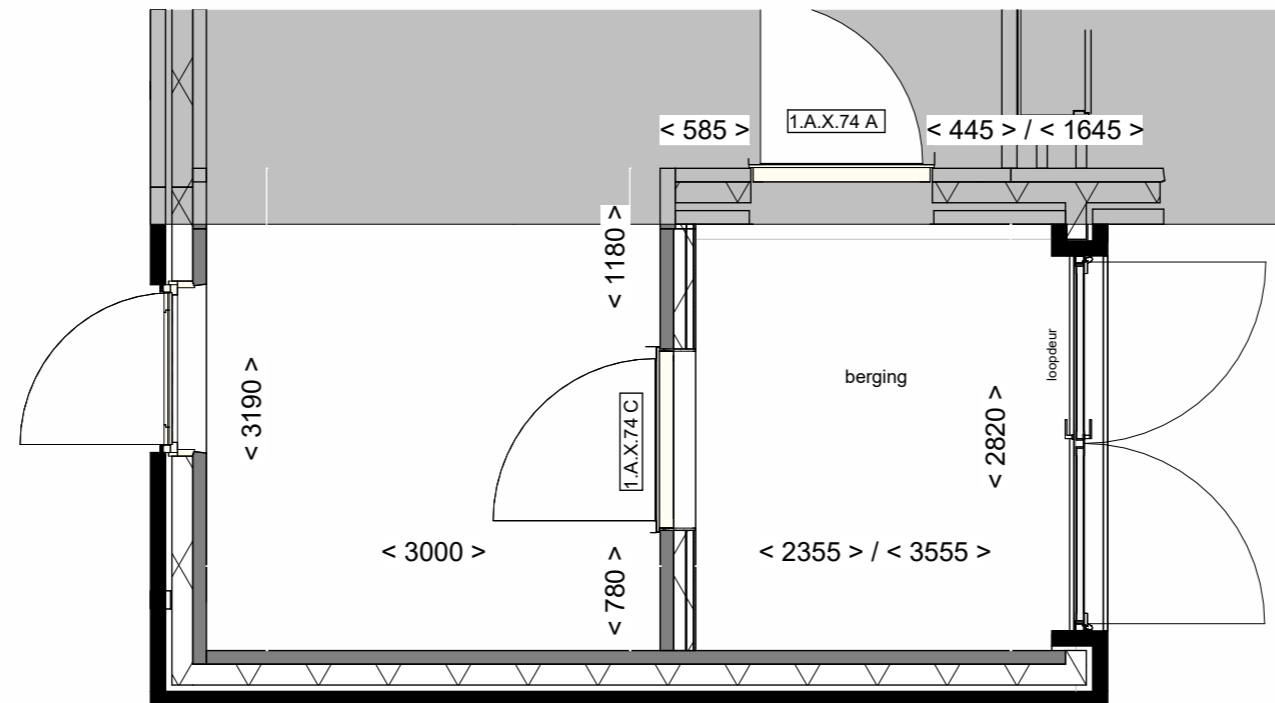

Voorgevel schaal 1:100



Buitendeur tussen
woning en berging

Tekening:

Woningtype: E60/F60/F60+

Bouwnummer: 1 t/m 19

Optienummer: 1.A.X.74 C

Bladformaat: A3

Schaal: 1:50

Datum: 21-04-2026

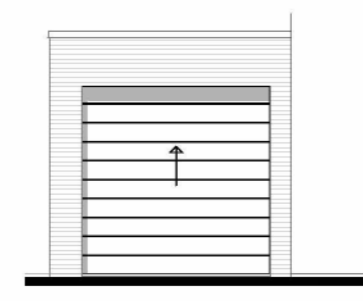
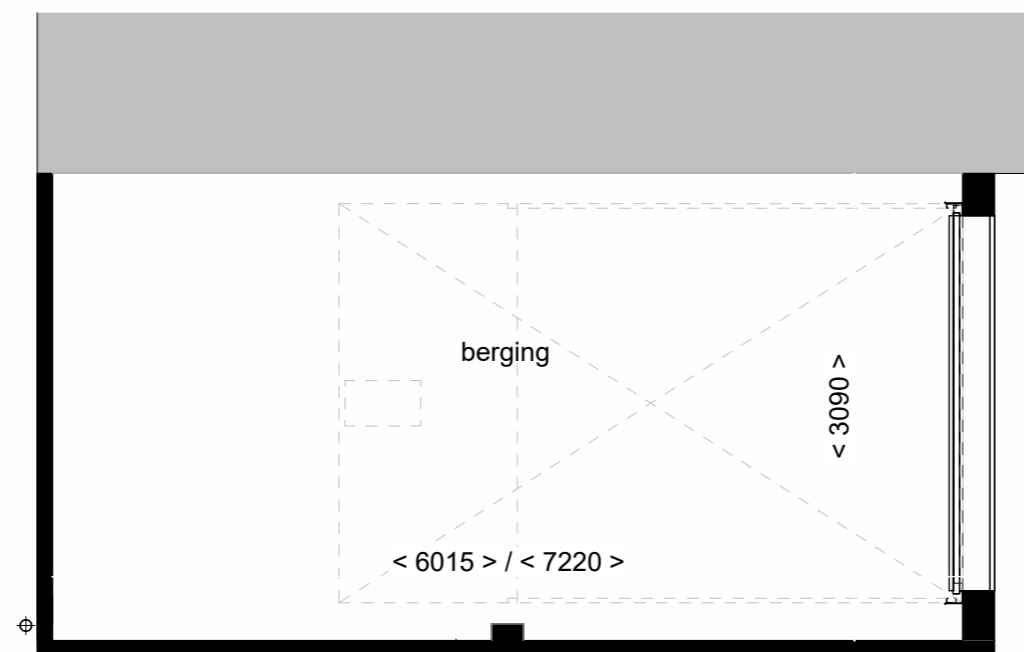

Voorgevel schaal 1:100



**Wonen aan
de Gantel**

Sectionaaldeur ipv
kanteldeur

Tekening:

Woningtype: E60/F60/F60+/F60D

Bouwnummer: 1 t/m 20

Optienummer: 1.A.X.80

Bladformaat: A3

Schaal: 1:50

Datum: 21-04-2026

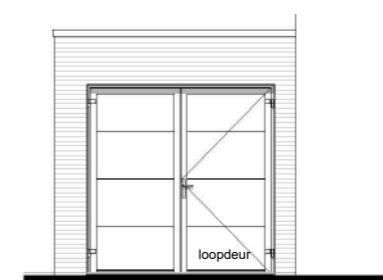
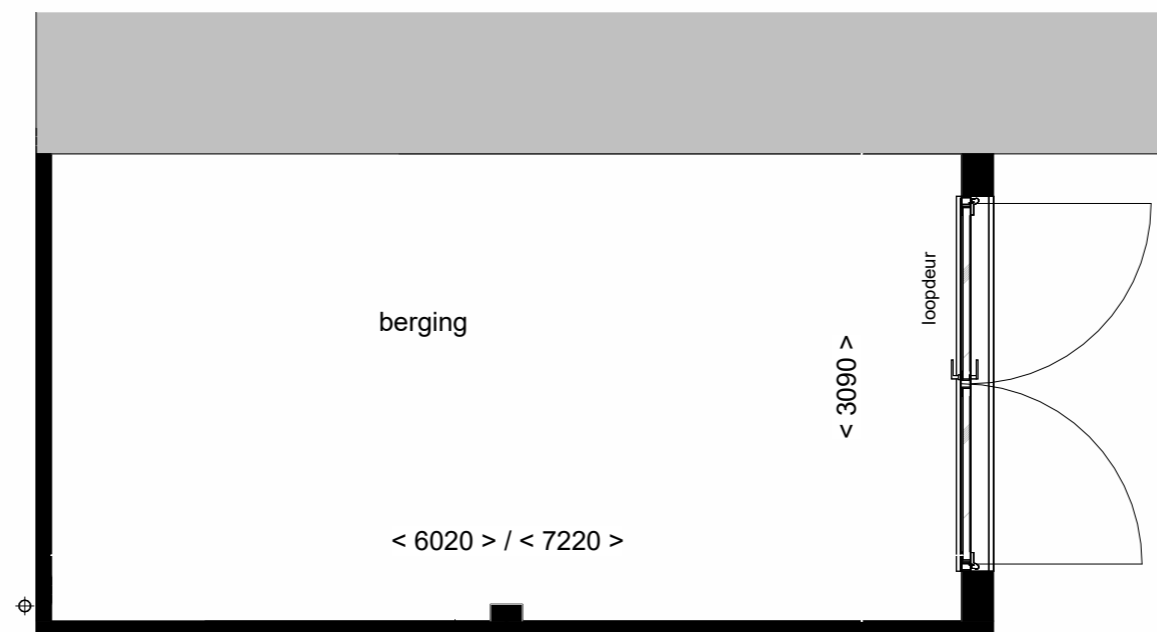

Voorgevel schaal 1:100



**Wonen aan
de Gantel**

Dubbele
openslaande deuren

Tekening: **Dubbele
openslaande deuren**

Woningtype: **E60/F60/F60+/F60D**

Bouwnummer: **1 t/m 20**

Optienummer: **1.A.X.84**

Bladformaat: **A3**

Schaal: **1:50**

Datum: **21-04-2026**

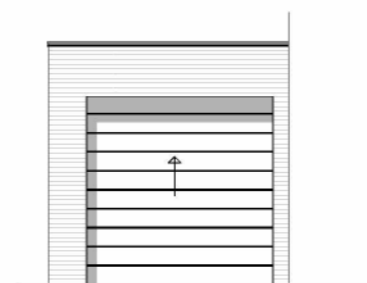
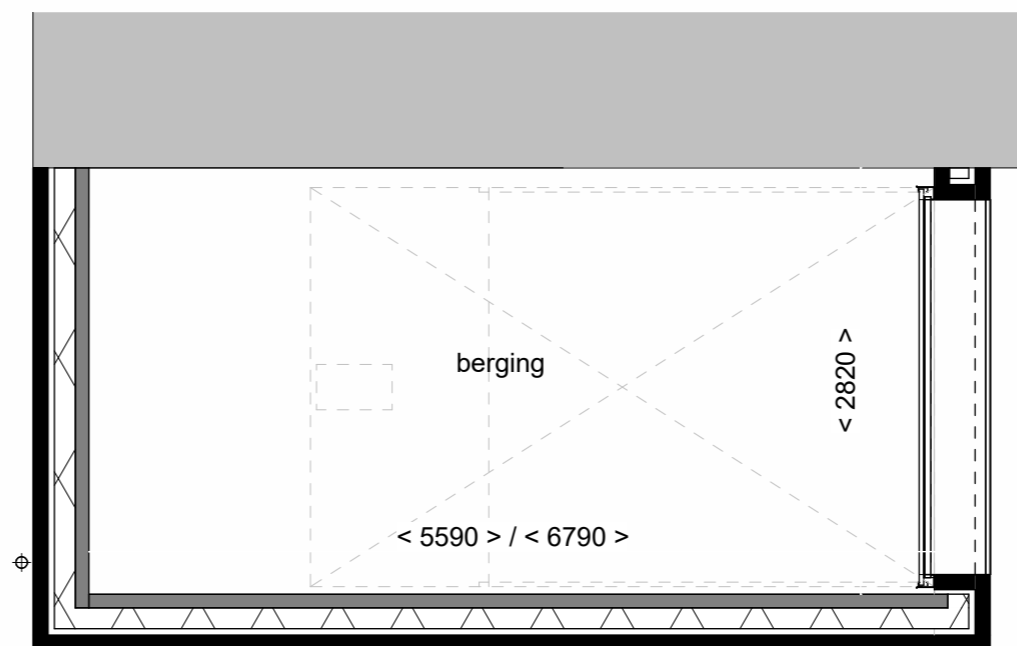

Voorgevel schaal 1:100



Achtergevel schaal 1:100



**Wonen aan
de Gantel**

Tekening: **Isoleren berging**

Woningtype: **E60/F60/F60+/F60D**

Bouwnummer: **01 t/m 20**

Optienummer: **1.A.X.86**

Bladformaat: **A3**

Schaal: **1:50**

Datum: **21-04-2026**

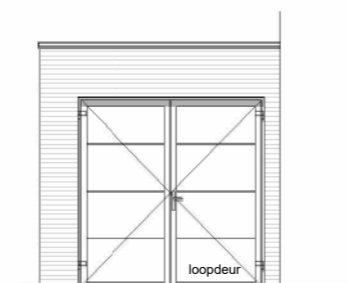
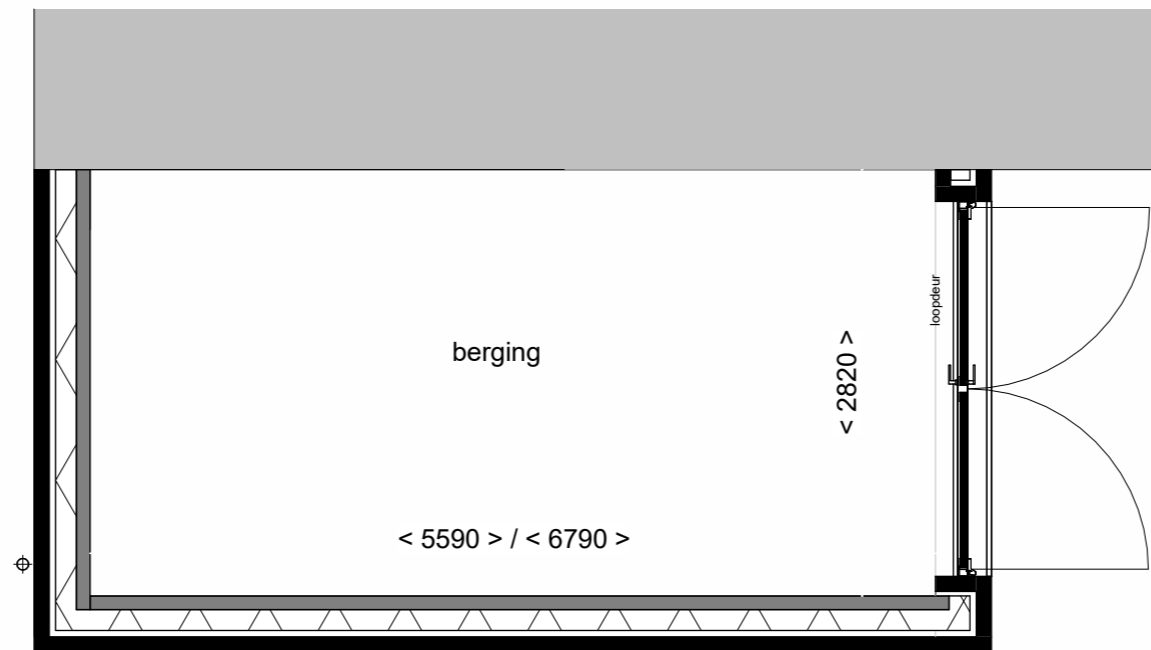

Voorgevel schaal 1:100



Achtergevel schaal 1:100



**Wonen aan
de Gantel**

Dubbele deuren,
isoleren

Tekening:

Woningtype: E60/F60/F60+/F60D

Bouwnummer: 1 t/m 20

Optienummer: 1.A.X.94

Bladformaat: A3

Schaal: 1:50

Datum: 21-04-2026