

### Renvooi

-  - entree woongebouw
-  - erfgrans
-  - parkeervak eigen terrein
-  - parkeervak openbaar
-  - houten vlonder
-  - pergola
-  - haag laag
-  - haag hoog
-  - water
-  - openbaar groen
-  - wandelpad houtsnippers
-  - voetpad
-  - inrit
-  - straat
-  - talud
-  - boom, positie in overleg met koper
-  - indicatie positie riolering
-  - zone erfdienstbaarheid
-  - klinkerbestrating

### parkeerplekken en posities bomen indicatief

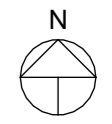

Tekening: **Situatie totaal**

---

Woningtype: **E60,E60D,F60,F60+**

---

Bouwnummer: **1 t/m 31**

---

Bladnummer: **VT-S-00**

---

Bladformaat: **A3**

---

Schaal: **1:750**

---

Datum: **21-04-2026**



- ### Renvooi
- entree woongebouw
  - erfgrens
  - parkeervak eigen terrein
  - parkeervak openbaar
  - houten vlonder
  - pergola
  - haag laag
  - haag hoog
  - water
  - openbaar groen
  - wandelpad houtsnippers
  - voetpad
  - straat
  - talud
  - boom, positie in overleg met koper
  - indicatie positie riolering
  - zone erfdienstbaarheid
  - klinkerbestrating

**parkeerplekken en posities bomen indicatief**

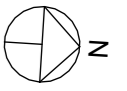

Tekening: **Situatie bnr. 1-5**

Woningtype: **F60, E60, E60D**

Bouwnummer: **1, 2, 3, 4, 5**

Bladnummer: **VT-S-01**

Bladformaat: **A3**

Schaal: **1:200**

Datum: **21-04-2026**

## Renvooi materialen



dakpan antracietgrijs



metselwerk kleur grijswit gesinterd  
code A: EN1166 WF WS



metselwerk kleur bruin nuance  
code B: HM1106 WF WS



metselwerk kleur bruin caramel  
code C: EN1165 WF WS



gevelbetimmering vuren vergrijsd

## Renvooi bouwkundig



entree woning



metselwerk

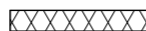

isolatie



dragende wand



niet dragende binnenwand

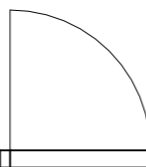

buitendeur

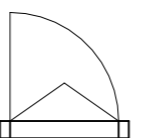

draairaam

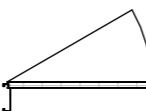

binnendeurkozijn (met bovenlicht)

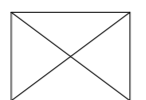

kruipluik



opstelplaats wasmachine



opstelplaats wasdroger



opstelplaats koelkast



principe opstelling keukenblok



onbenoemde ruimte volgens krijtstreepmethode

## Renvooi installaties



aansluitpunt licht, wand



centraaldoos met lichtpunt



armatuur aan de wand



rookmelder



aansluitpunt niet bedraad / loos



aansluitpunt bedraad data, niet afgemonteerd



beldrukker



schel



schakelaar, 1-polig



werkschakelaar tbv PV-panelen



driestandenschakelaar tbv wtw



schakelaar, wissel



schakelaar, serie



pulsschakelaar tbv warmteterugwinunit



wandcontactdoos 1-voudig met beschermingscontact



wandcontactdoos 2-voudig met beschermingscontact



thermostaatleiding, bedraad



wandcontactdoos tbv warmteterugwinunit



wtw mechanische ventilatie-unit incl. warmteterugwinunit



wp warmtepomp



inblaasventiel mechanische ventilatie



afzuigventiel mechanische ventilatie



verdelers vloerverwarming



ruimte vzv vloerverwarming



elektrische radiator

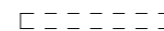

kanalen in het zicht



doucheput



lijngoot douche



buitenkraan

### Disclaimer

De op deze tekeningen aangegeven maten zijn circa maten in millimeters en tussen de wanden / vloeren gemeten, waarbij geen rekening is gehouden met enige wandafwerking, plinten, aftimmering, etc. In verband met de nauwkeurige uitwerking van details, constructie, maatvoering, materialen e.d. kunnen er kleine afwijkingen ontstaan ten opzichte van de nu vermelde gegevens. Deze geringe afwijkingen geven geen aanleiding tot verrekening. Aan de op deze tekening aangegeven maten kunnen derhalve geen rechten worden ontleend. De op deze tekeningen aangegeven maatvoering is niet geschikt voor opdrachten aan derden door koper(s). De posities van aansluitingen en installatie onderdelen zijn indicatief op tekening aangegeven. De exacte aantallen en posities zullen na berekening in het werk door de installateurs worden bepaald en kunnen afwijken van deze tekening.



Wonen aan  
de Gantel

Tekening: Renvooi

Woningtype: E60 / F60 / F60+

Bouwnummer: 1 t/m 31

Bladnummer: VT-0-00c

Bladformaat: A3

Schaal: 1 : 50

Datum: 21-04-2026



Vorgevel

Type: E60D  
bnr: 2

Type: E60  
bnr: 3

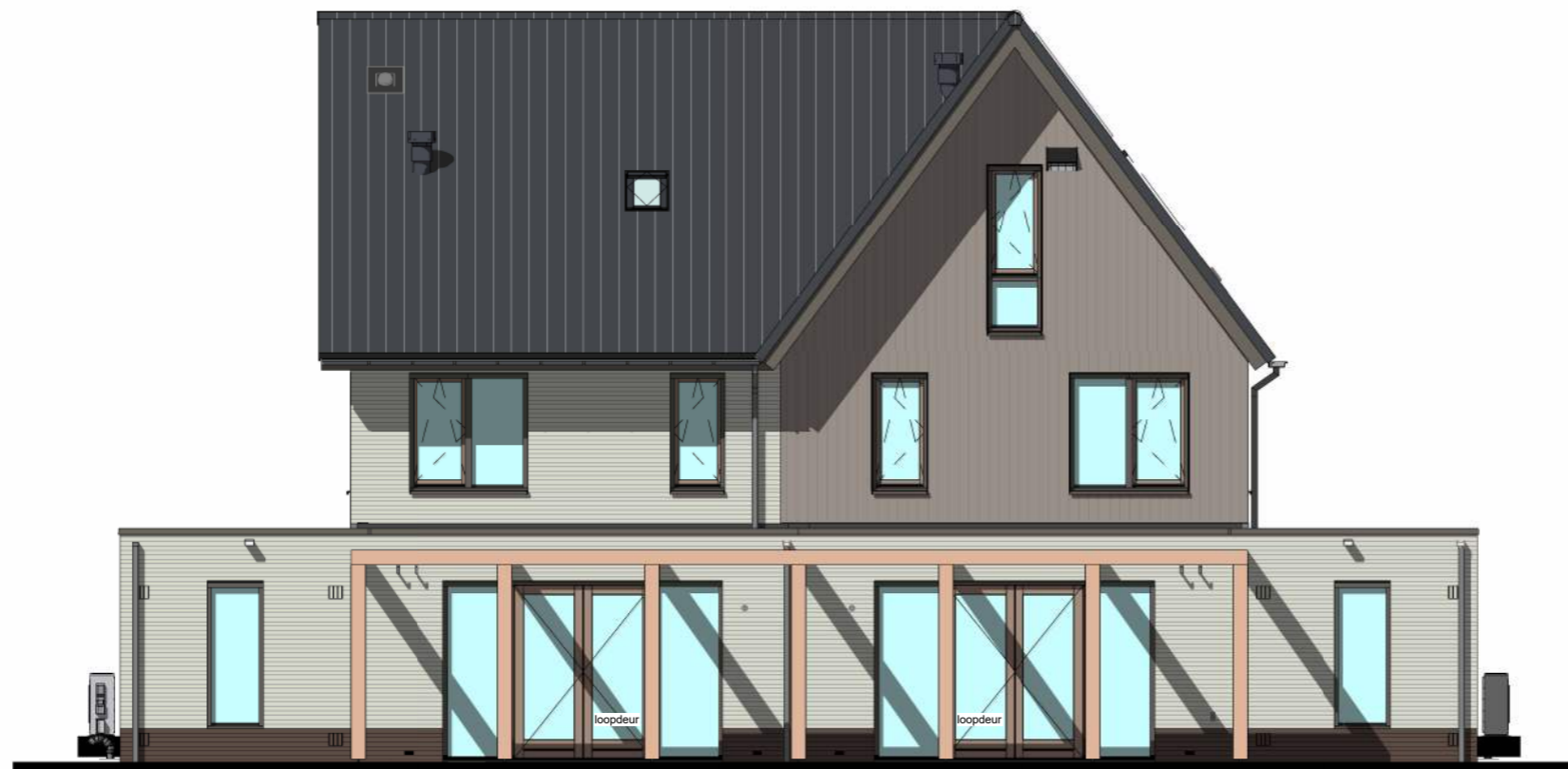

Achtergevel

Type: E60  
bnr: 3

Type: E60D  
bnr: 2



Tekening: Gevels blok 2

Woningtype: E60D / E60

Bouwnummer: 2 / 3

Bladnummer: VT-02-00a

Bladformaat: A3

Schaal: 1 : 100

Datum: 21-04-2026

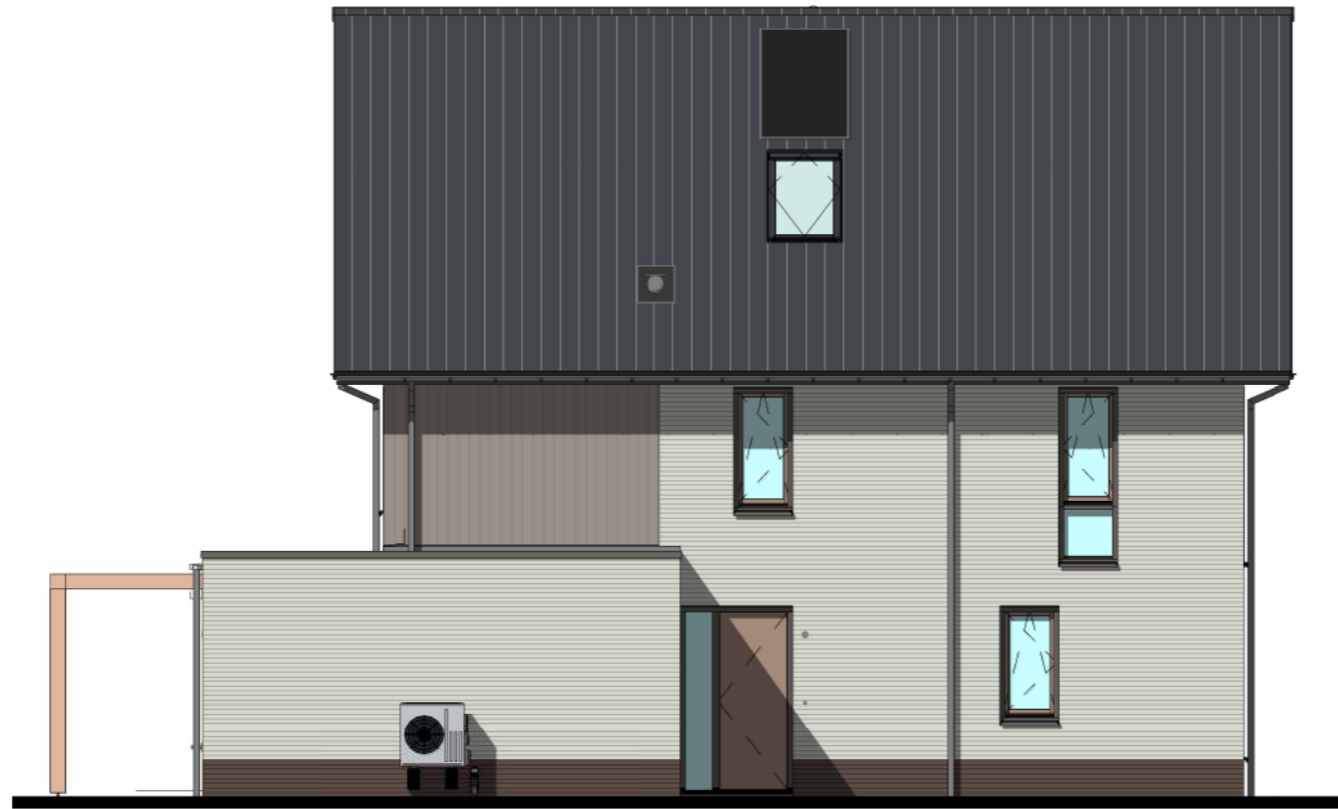

Linker zijgevel

Type: E60D  
bnr: 2



Rechter zijgevel

Type: E60  
bnr: 3



Tekening: Zijgevels blok 2

Woningtype: E60D / E60

Bouwnummer: 2 / 3

Bladnummer: VT-02-00b

Bladformaat: A3

Schaal: 1 : 100

Datum: 21-04-2026

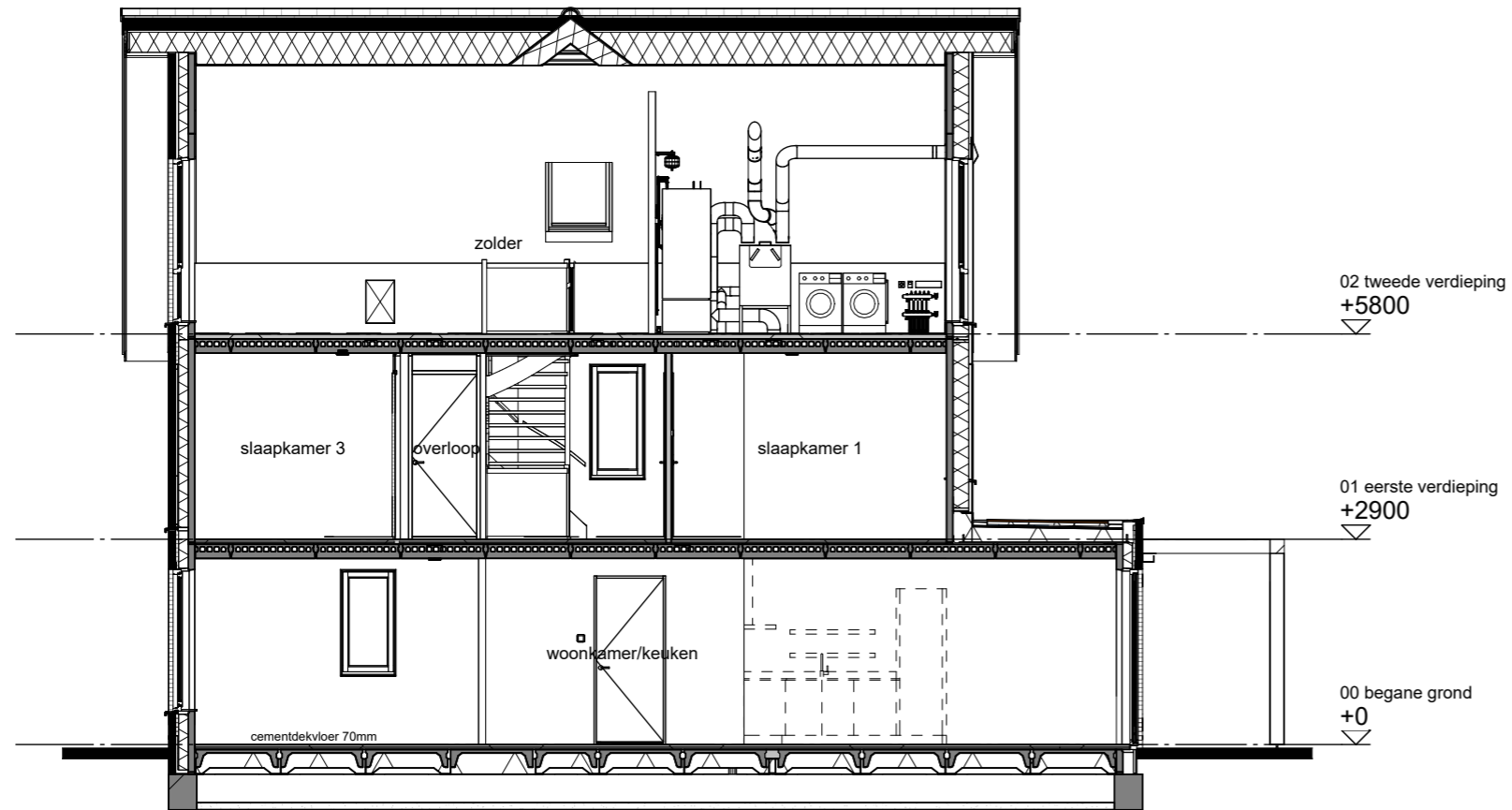

Doorsnede A-A

Type: E60D  
bnr: 2

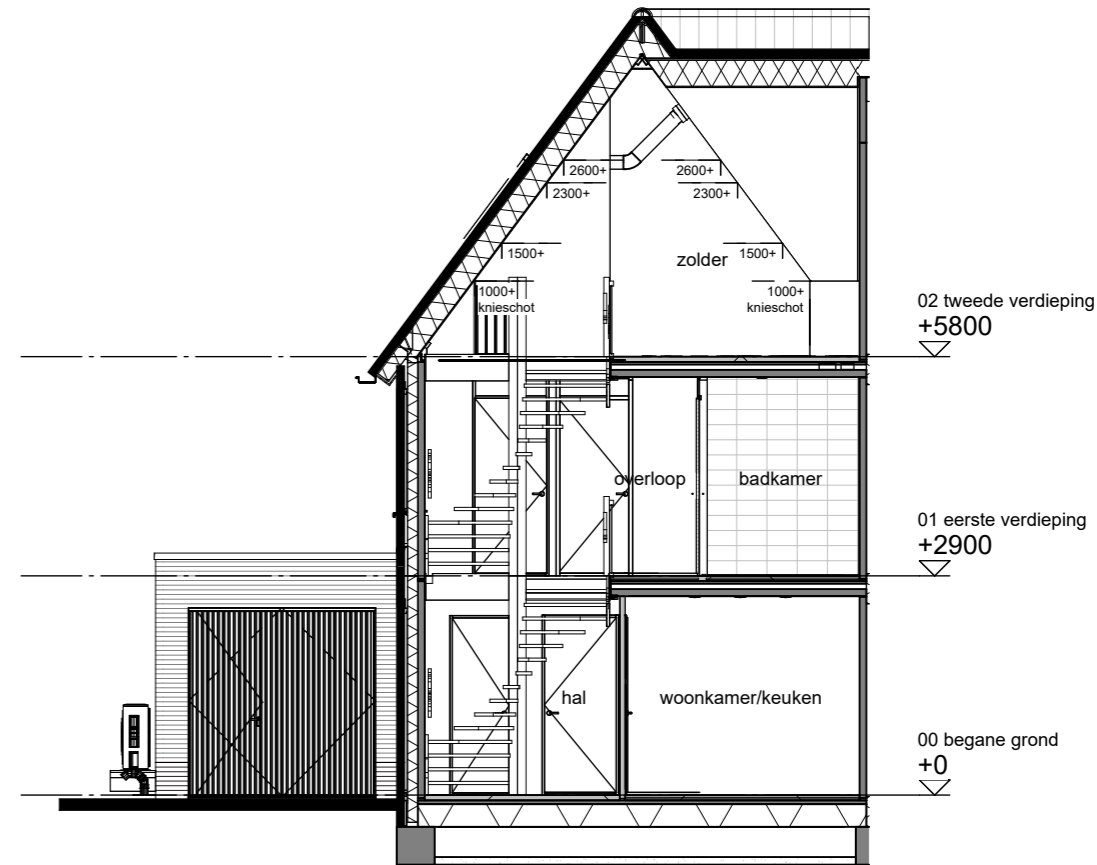

Doorsnede C-C

Type: E60D  
bnr: 2

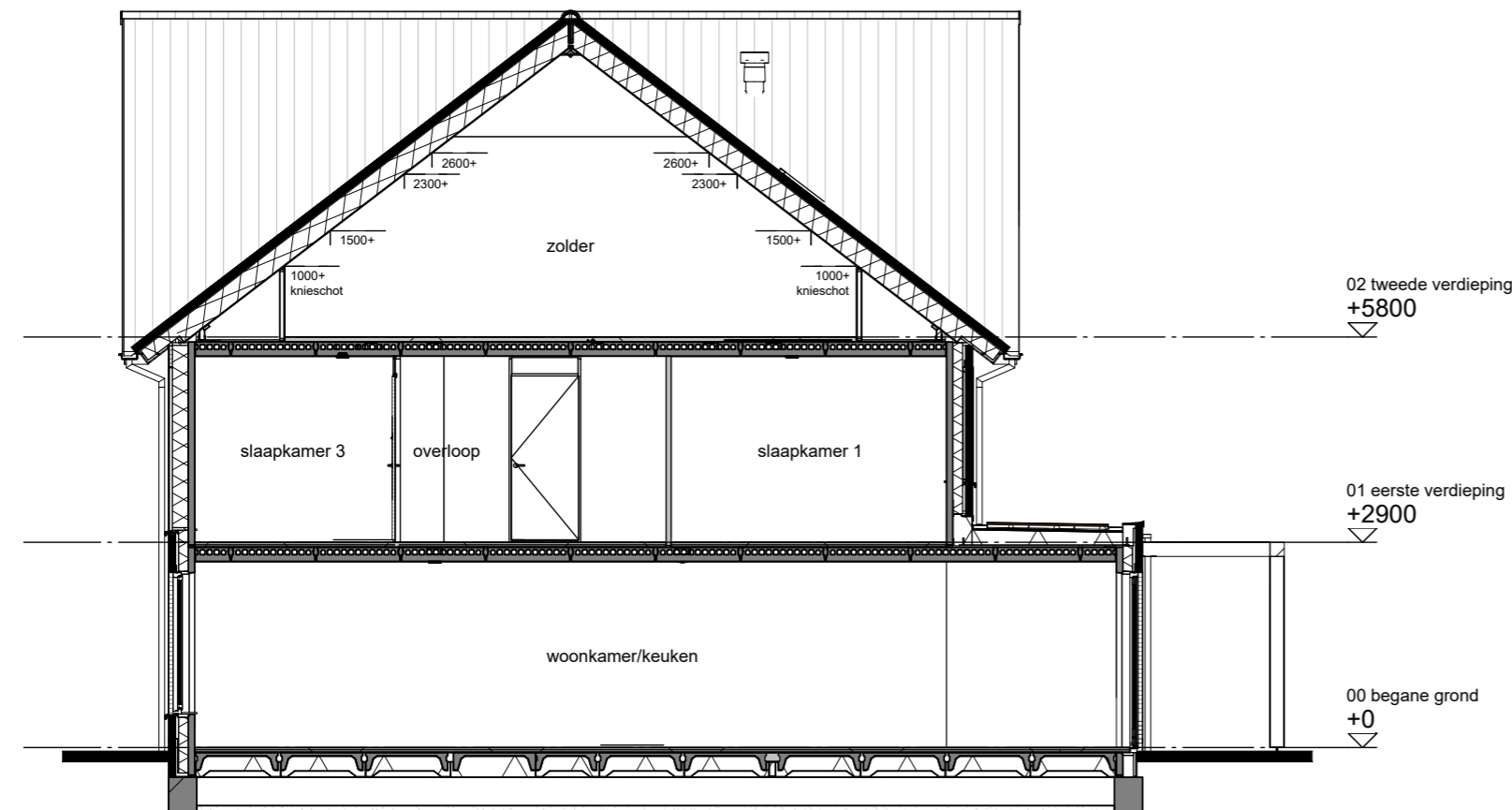

Doorsnede B-B

Type: E60  
bnr: 3



Tekening: Doorsn. blok 2

Woningtype: E60D / E60

Bouwnummer: 2 / 3

Bladnummer: VT-02-00c

Bladformaat: A3

Schaal: 1 : 100

Datum: 21-04-2026

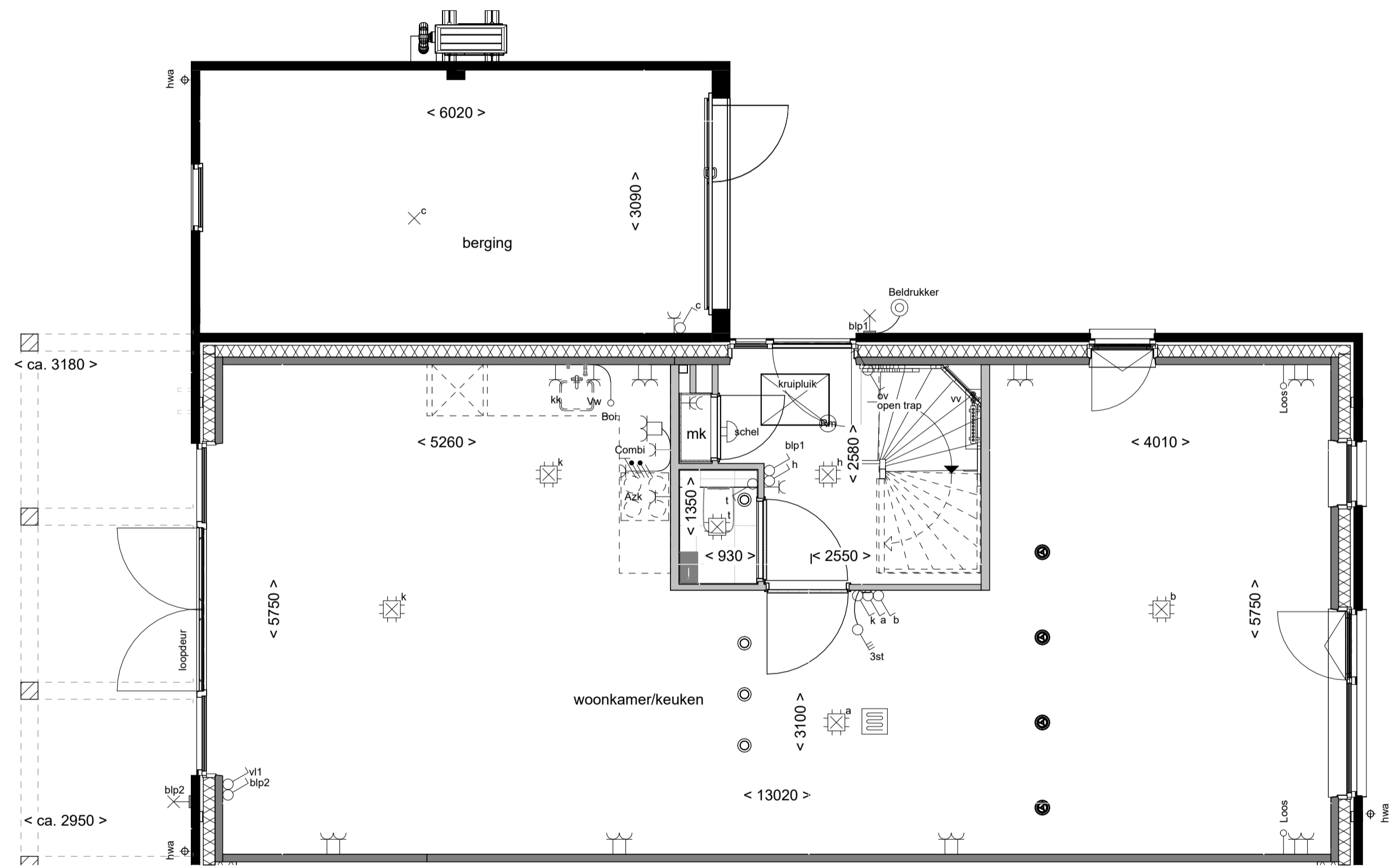
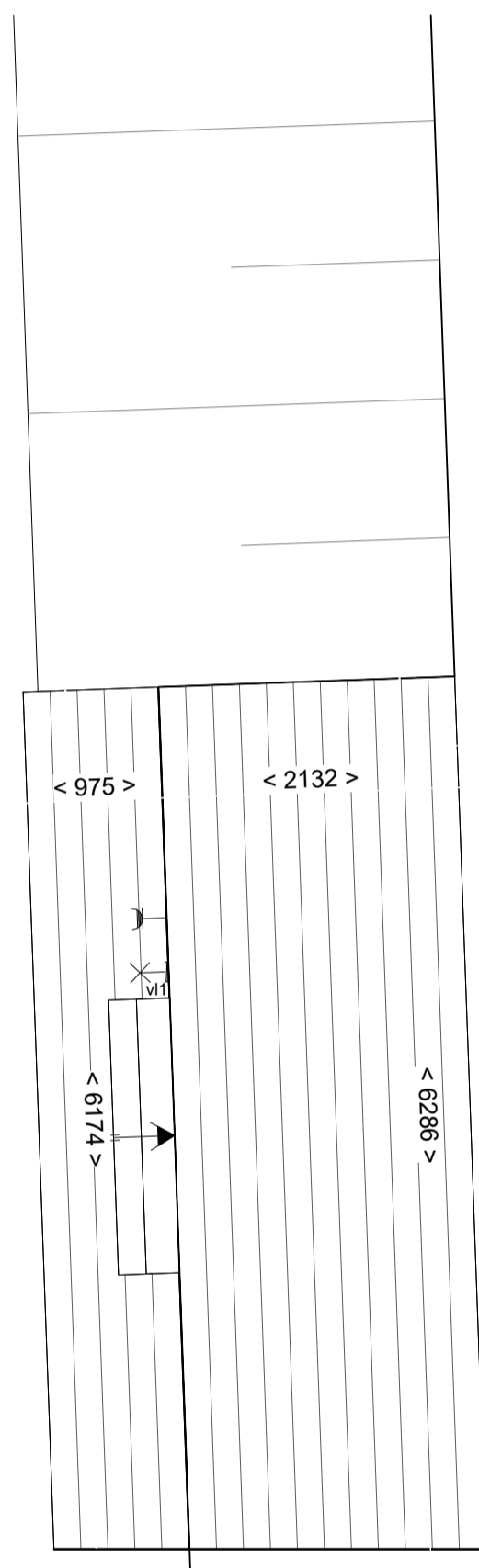

Tekening: **Begane grond**  
 Woningtype: **E60**  
 Bouwnummer: **3**  
 Bladnummer: **VT-02-03a**  
 Bladformaat: **A2**  
 Schaal: **1 : 50**  
 Datum: **21-04-2026**

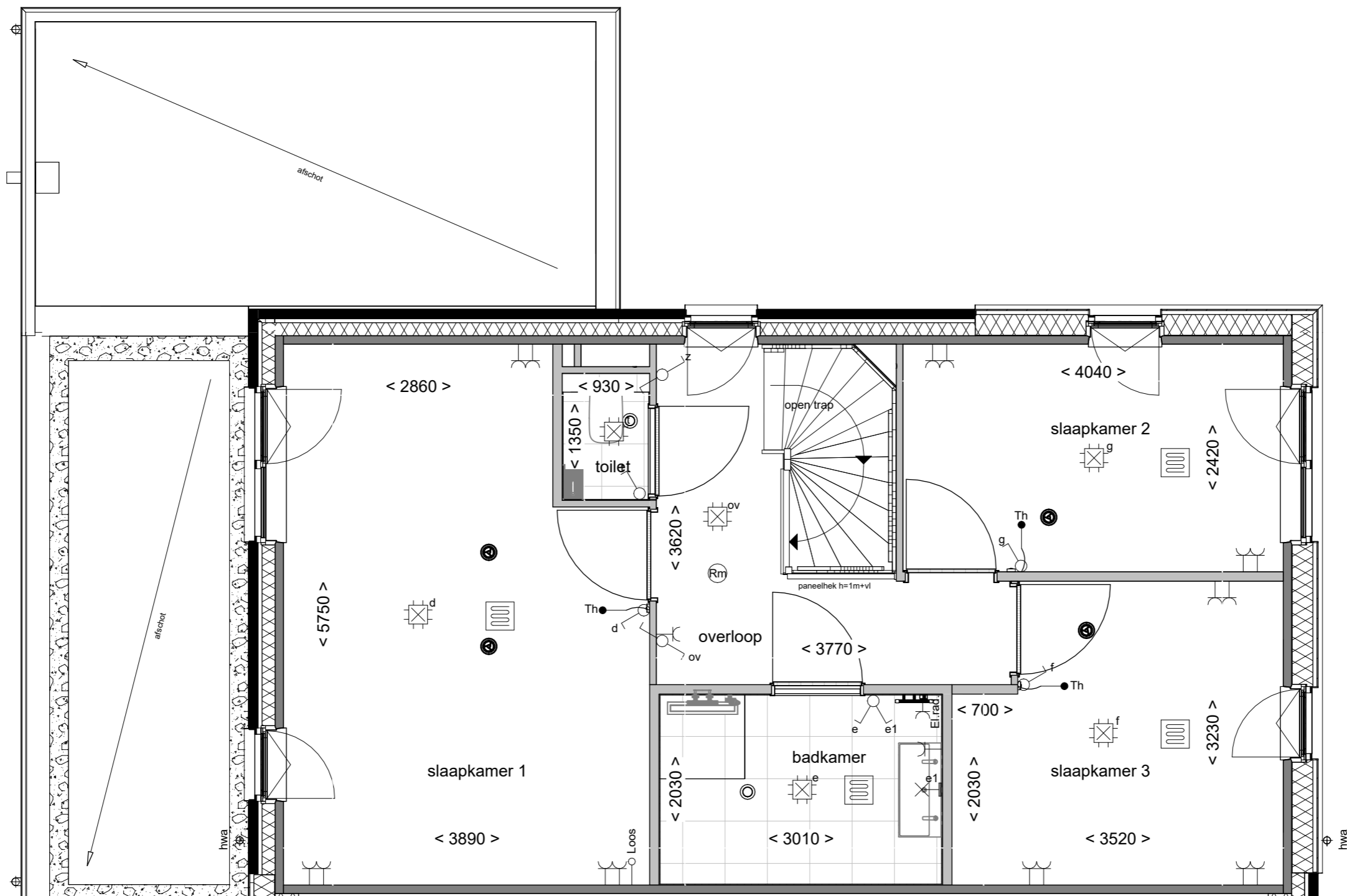

Tekening: **Eerste verdieping**

Woningtype: **E60**

Bouwnummer: **3**

Bladnummer: **VT-02-03b**

Bladformaat: **A3**

Schaal: **1 : 50**

Datum: **21-04-2026**

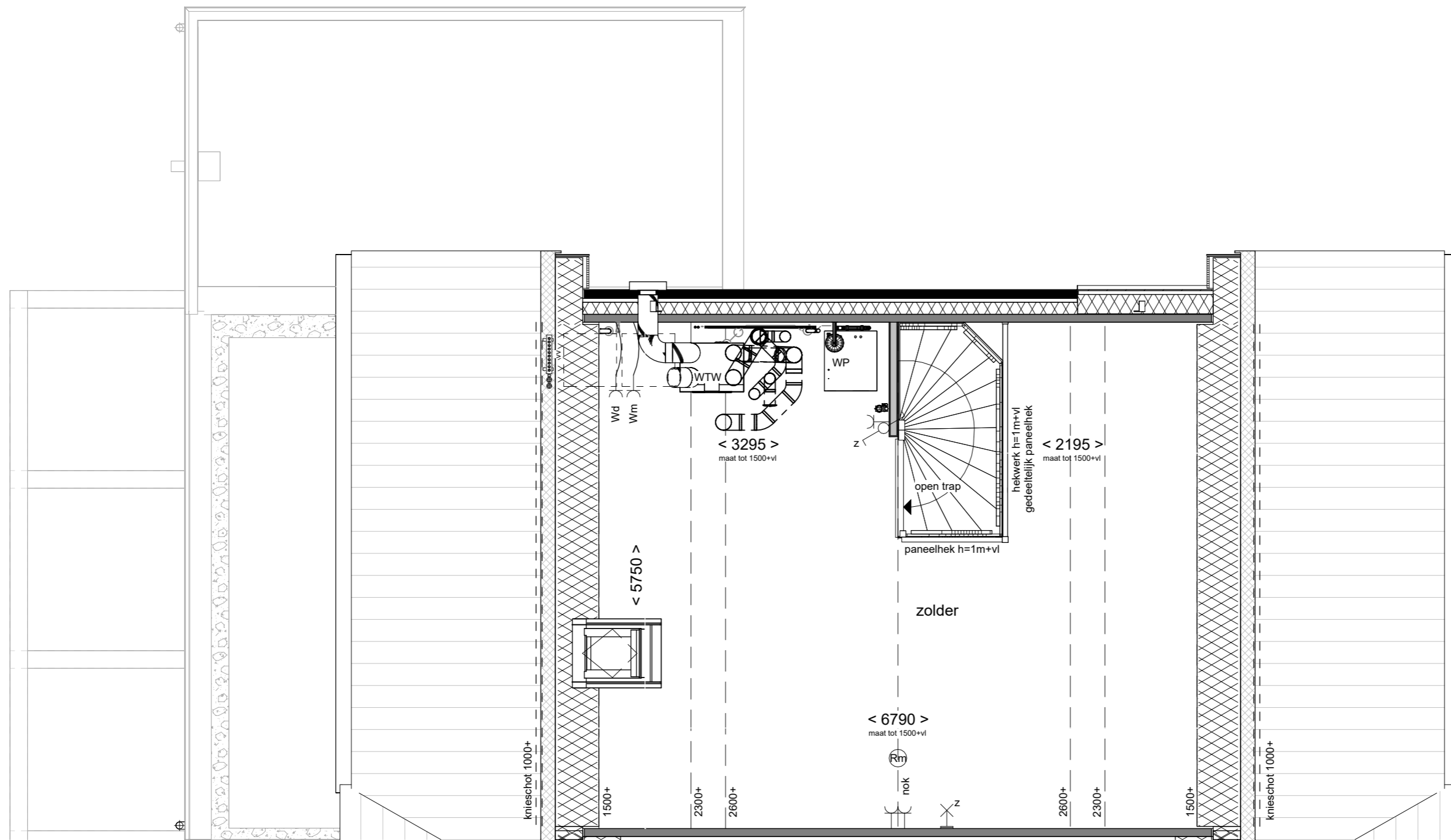

Tekening: Tweede verdieping

Woningtype: E60

Bouwnummer: 3

Bladnummer: VT-02-03c

Bladformaat: A3

Schaal: 1 : 50

Datum: 21-04-2026

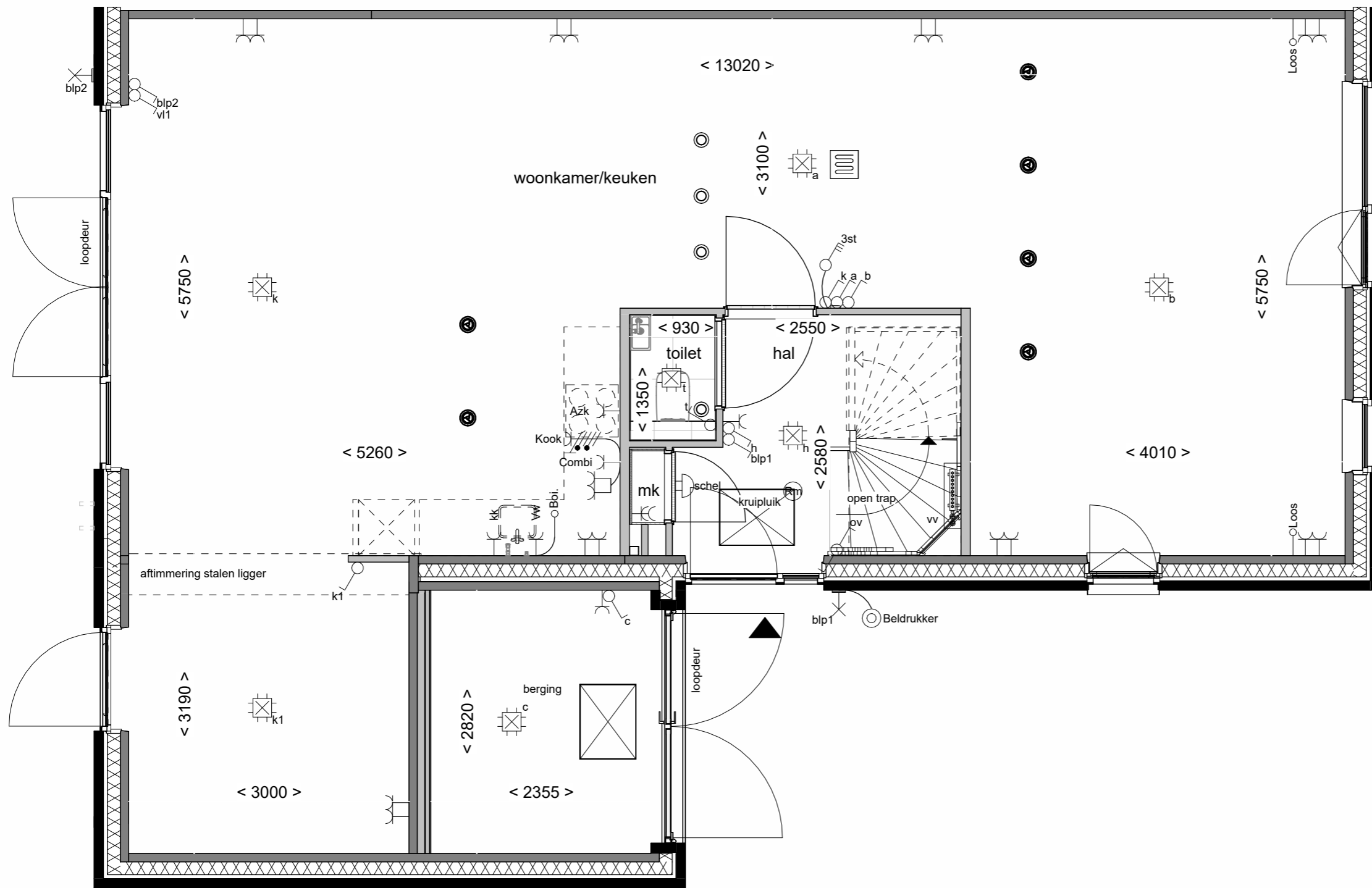

Begane grond

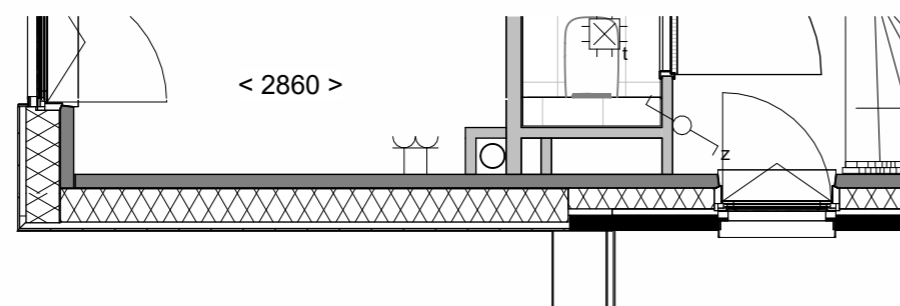

Eerste verdieping (extra schacht)



Achtergevel schaal 1:100



**Samenvoegen  
berging bij wnk**

Tekening:	Samenvoegen berging bij wnk
Woningtype:	E60
Bouwnummer:	-
Optienummer:	1.A.E.14
Bladformaat:	A3
Schaal:	1:50 / 1:100
Datum:	21-04-2026

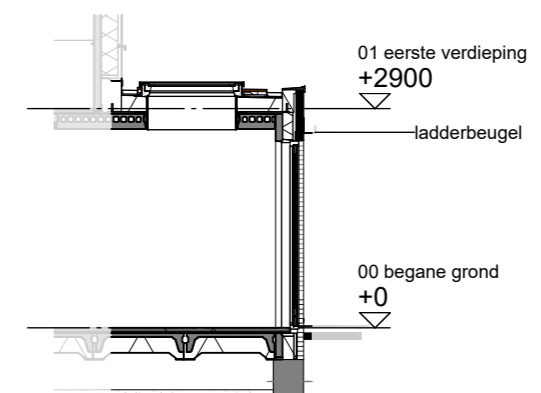
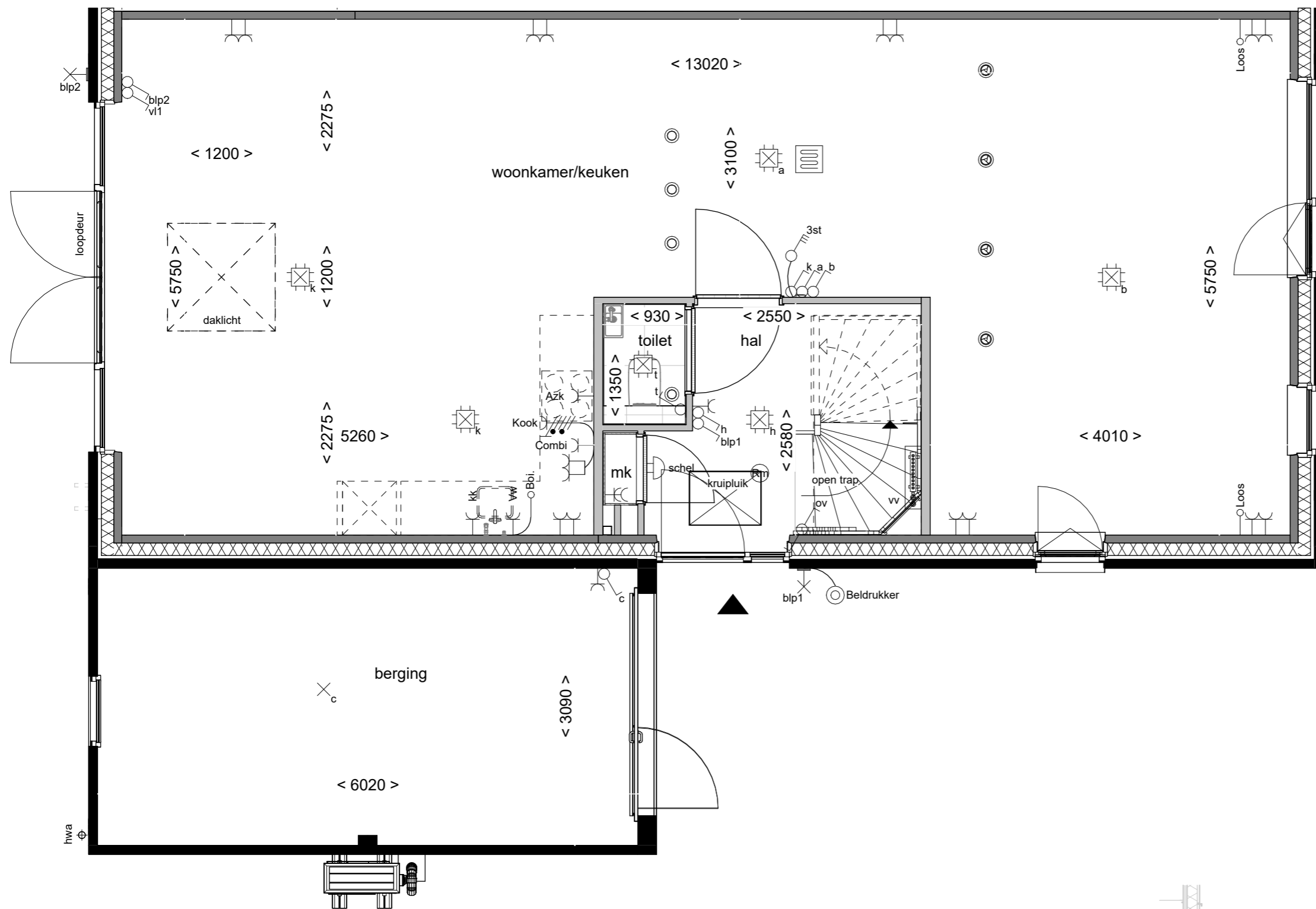

Doorsnede schaal 1:100



Tekening:	Lichtkoepel in uitbouw 240cm
Woningtype:	E60
Bouwnummer:	-
Optienummer:	1.B.X.10
Bladformaat:	A3
Schaal:	1:50 / 1:100
Datum:	21-04-2026

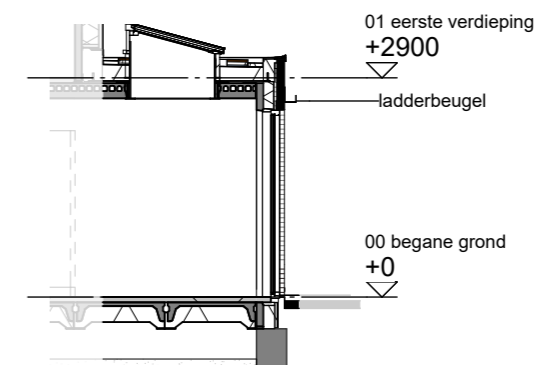
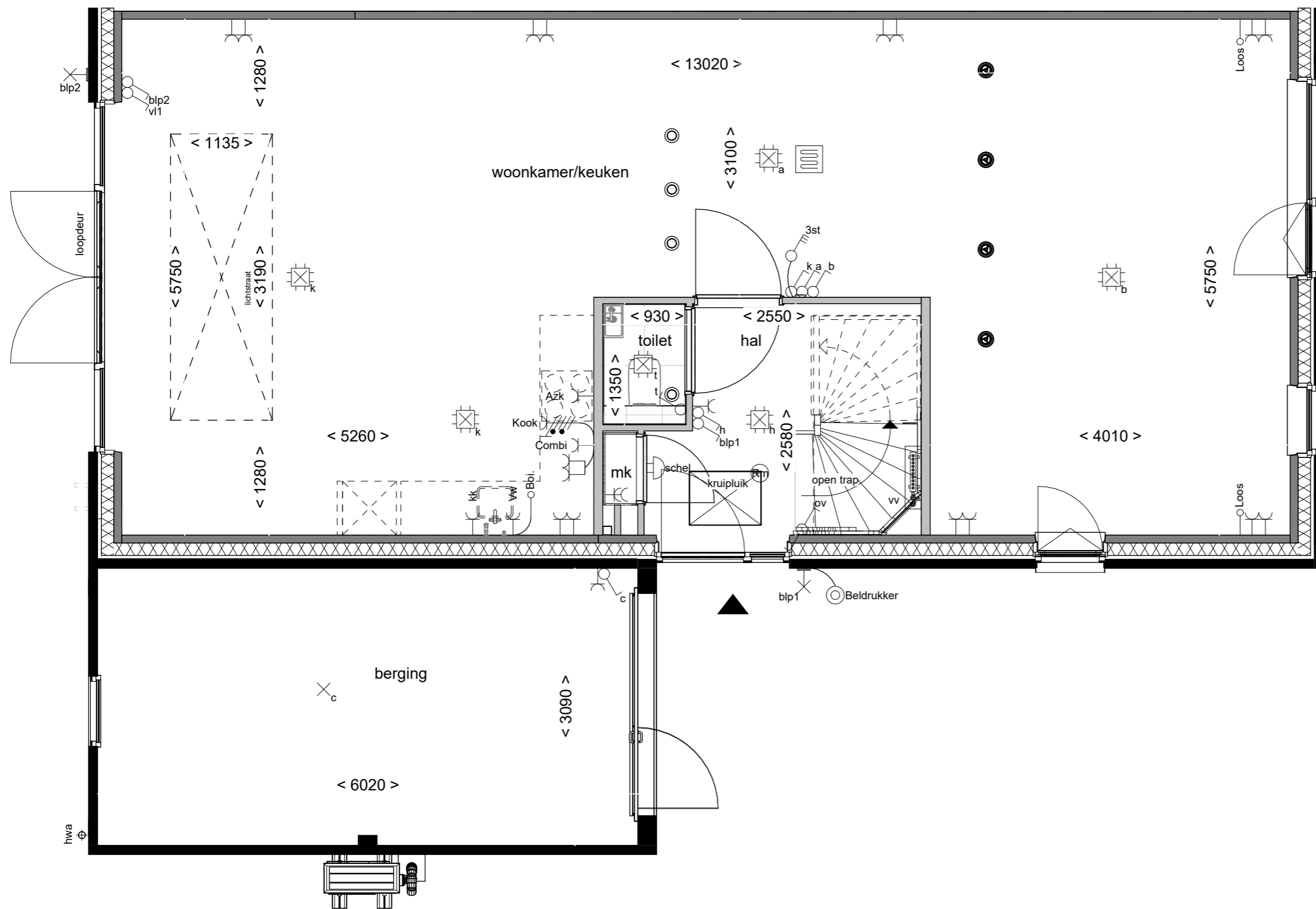

Doorsnede schaal 1:100



Lichtstraat in uitbouw  
240cm

Tekening:	Lichtstraat in uitbouw 240cm
Woningtype:	E60
Bouwnummer:	-
Optienummer:	1.B.X.14
Bladformaat:	A3
Schaal:	1:50 / 1:100
Datum:	21-04-2026

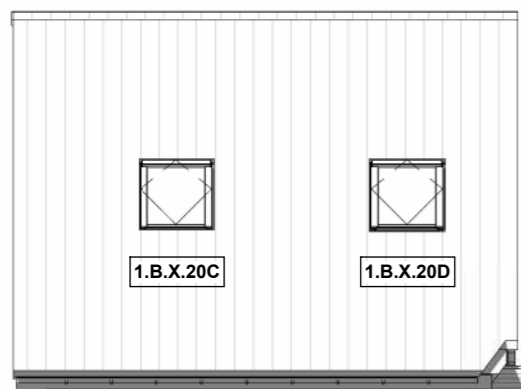
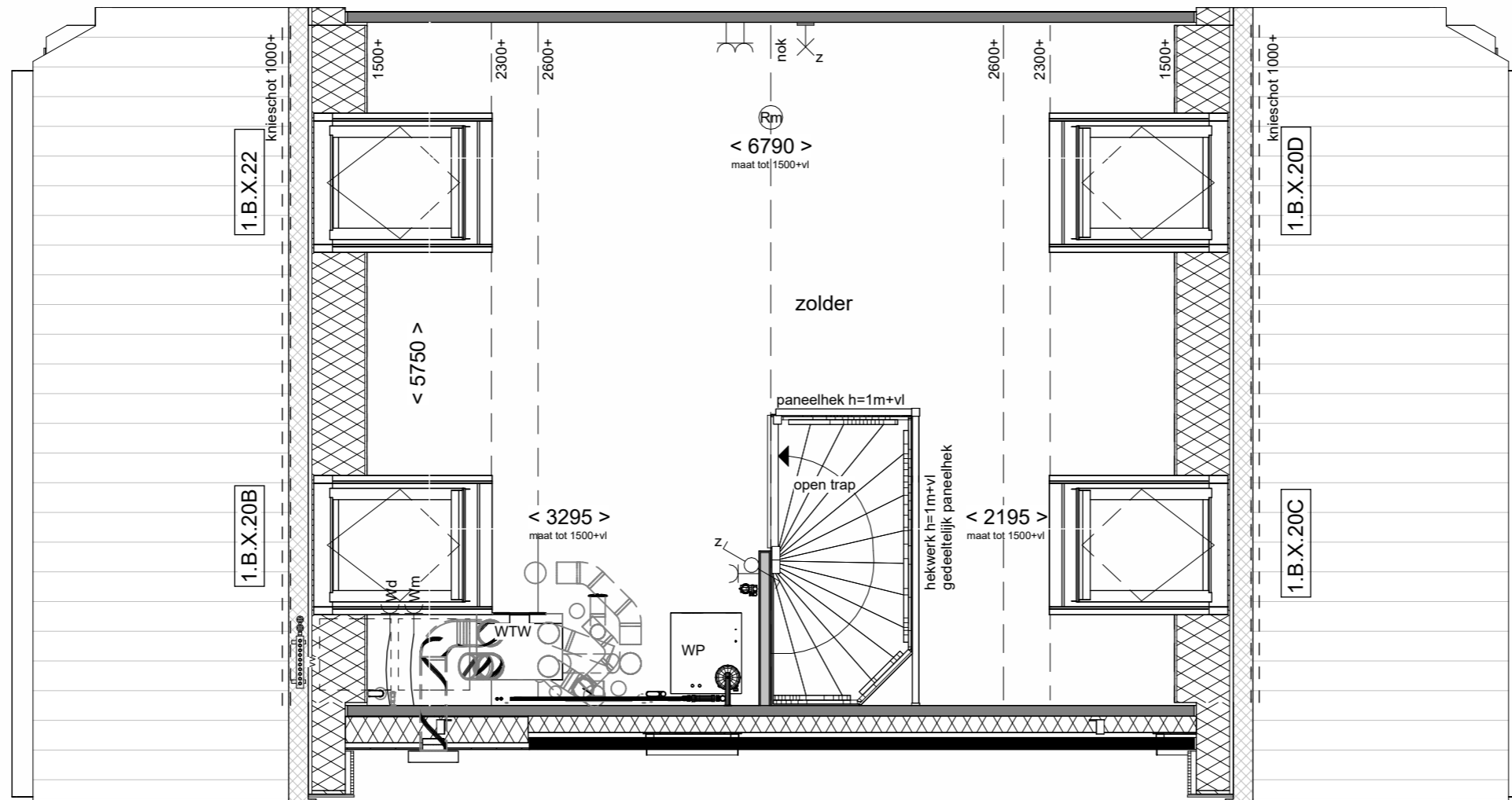

Voorgevel schaal 1:100

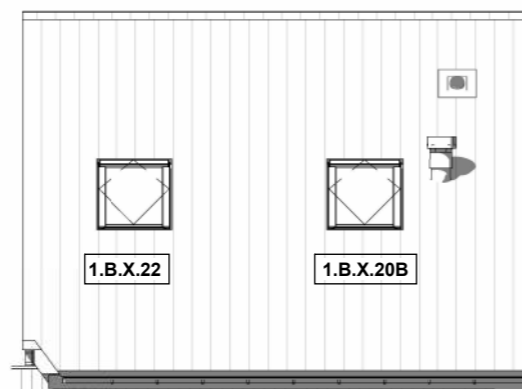

Achtergevel schaal 1:100

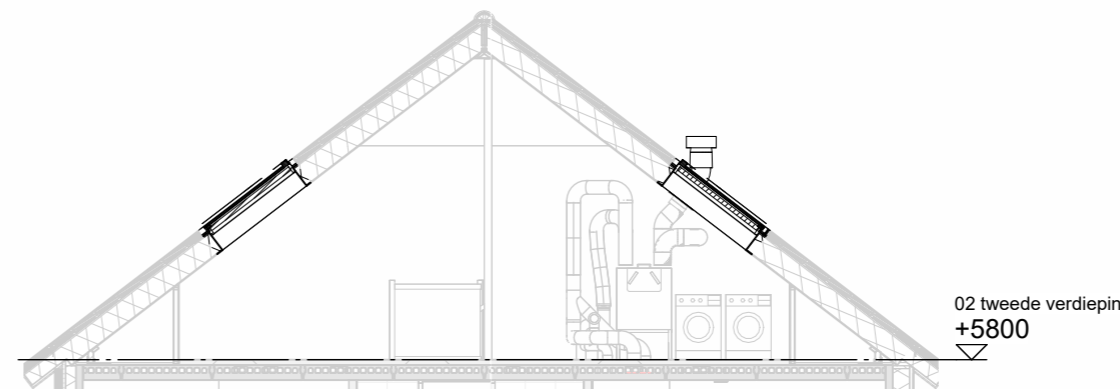

Doorsnede schaal 1:100



Dakramen voor- en achtergevel

Tekening:

Woningtype: E60

Bouwnummer: -

Optienummer: 1.B.X.20 / 1.B.X.22

Bladformaat: A3

Schaal: 1:50 / 1:100

Datum: 21-04-2026

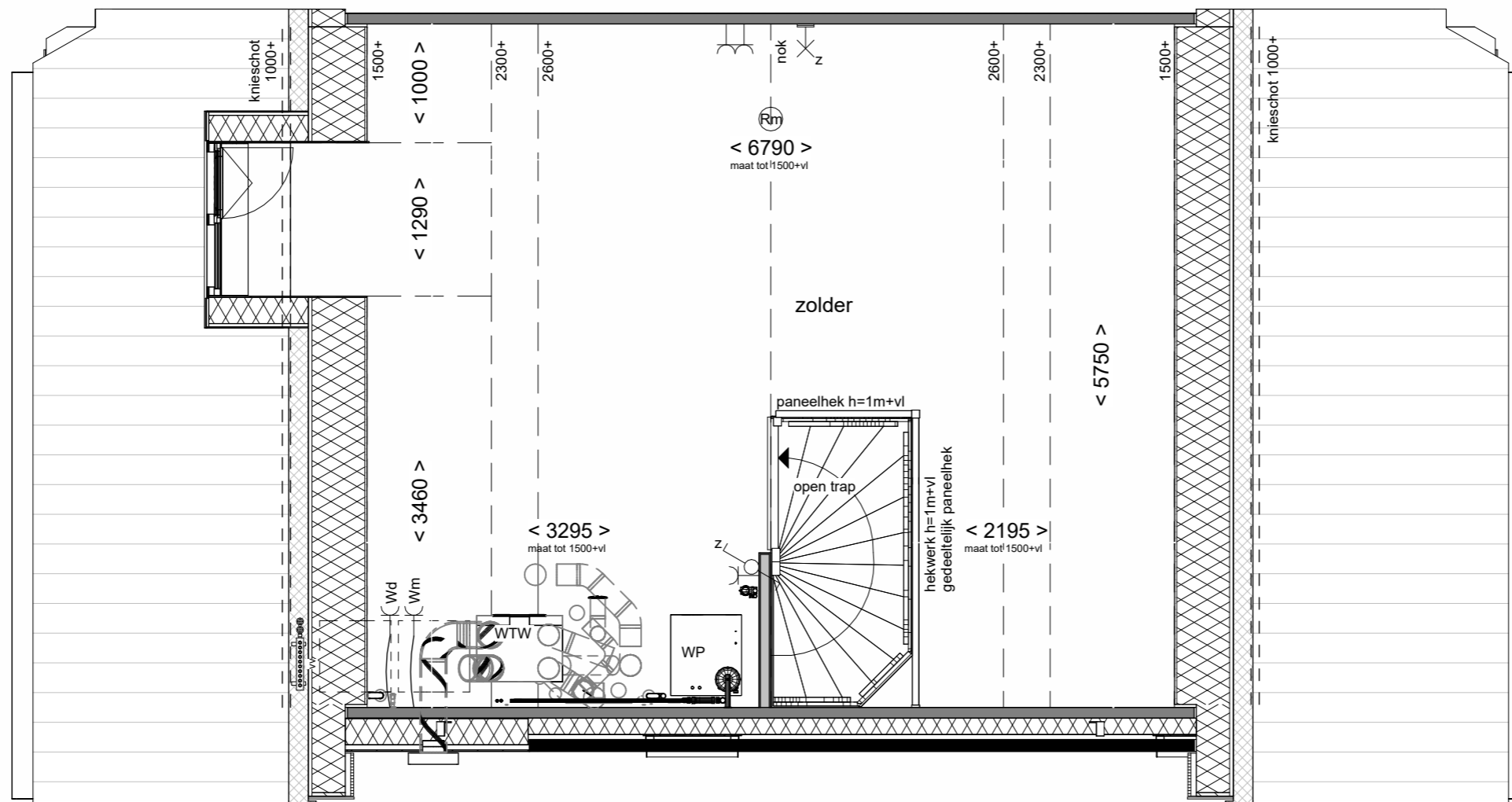

Achtergevel schaal 1:100

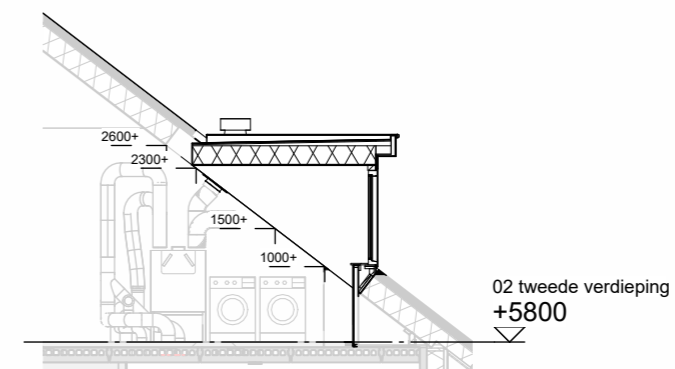

Doorsnede schaal 1:100



Tekening: Dakkapel achtergevel 130cm

Woningtype: E60

Bouwnummer: -

Optienummer: 1.B.X.32

Bladformaat: A3

Schaal: 1:50 / 1:100

Datum: 21-04-2026



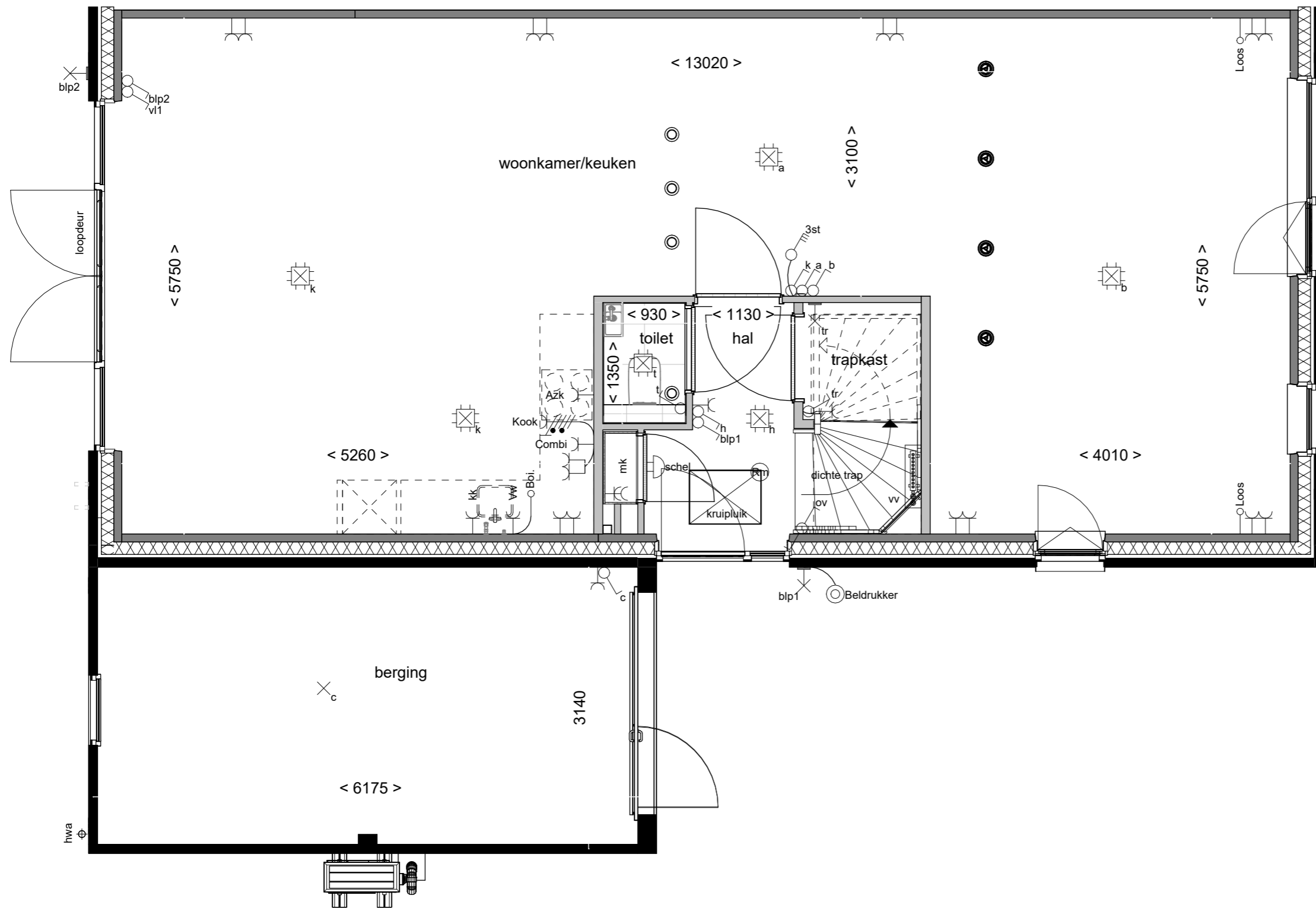

Tekening: Trapkast

Woningtype: E60

Bouwnummer: -

Optienummer: 1.C.E.10

Bladformaat: A3

Schaal: 1:50

Datum: 21-04-2026

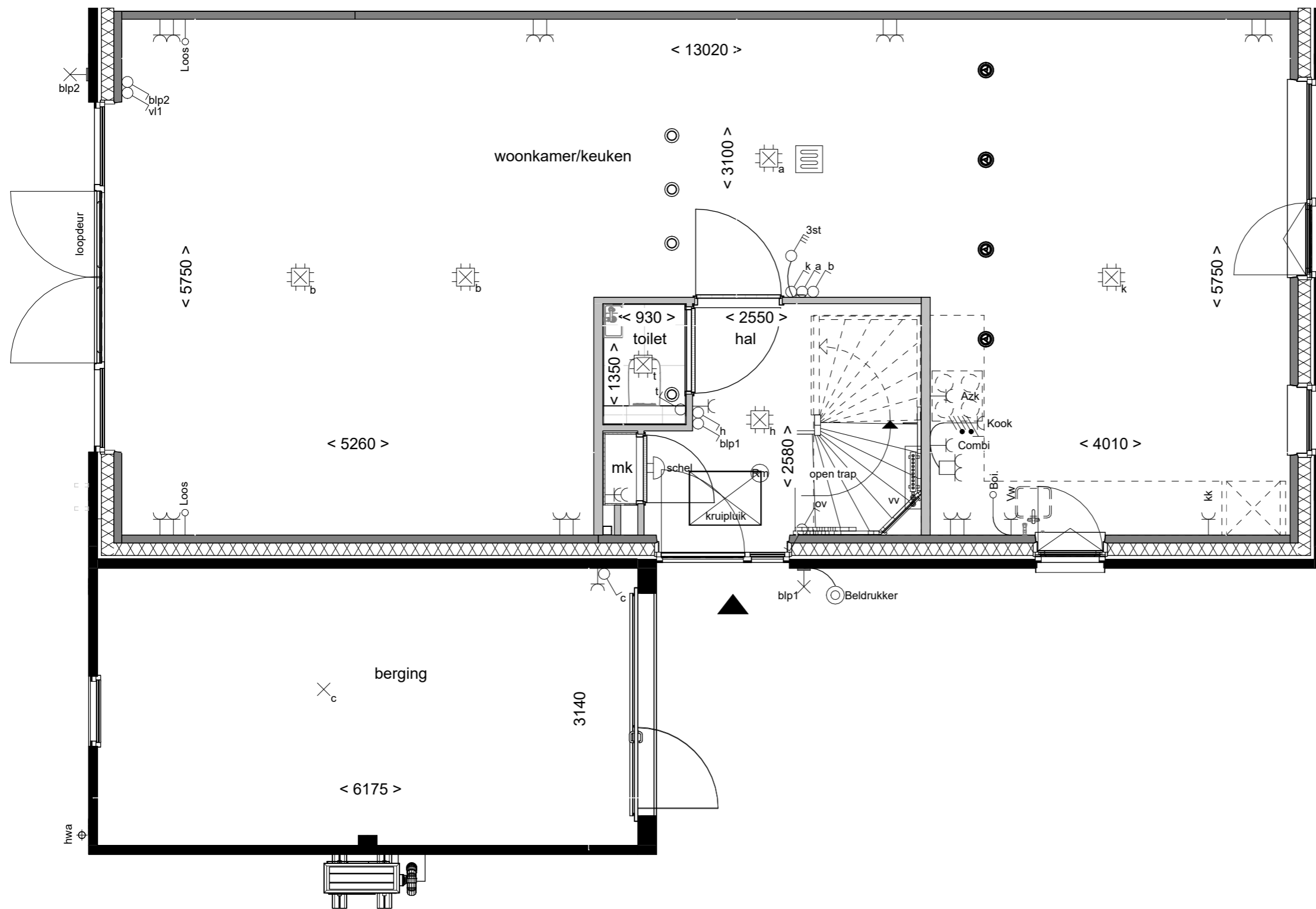

Tekening: **Tuingericht wonen**  
 Woningtype: **E60**  
 Bouwnummer: **-**  
 Optienummer: **1.C.E.12**  
 Bladformaat: **A3**  
 Schaal: **1:50**  
 Datum: **21-04-2026**

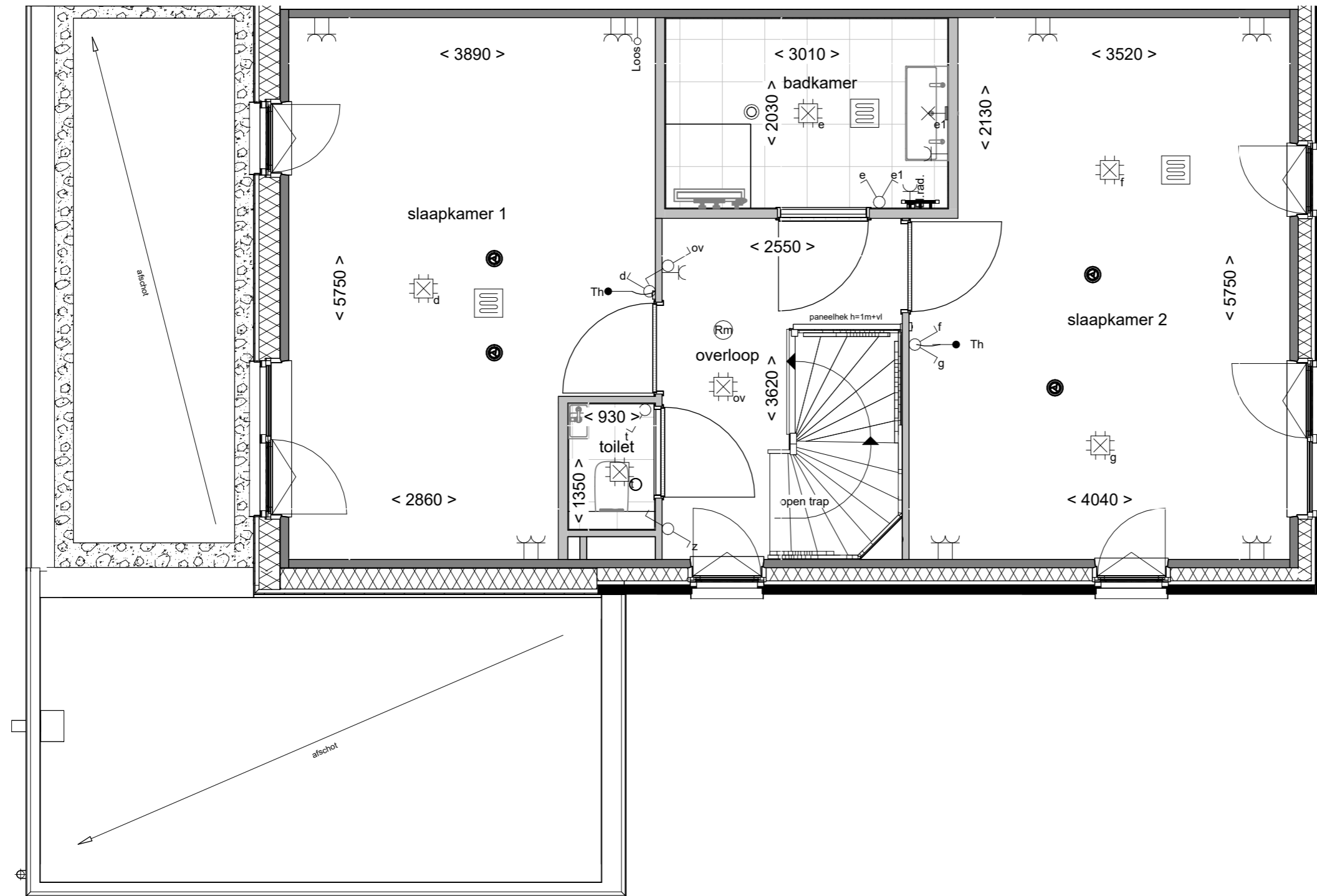

Samenvoegen  
slaapkamers voor

Tekening: \_\_\_\_\_

Woningtype: E60

Bouwnummer: -

Optienummer: 1.C.E.30

Bladformaat: A3

Schaal: 1:50

Datum: 21-04-2026

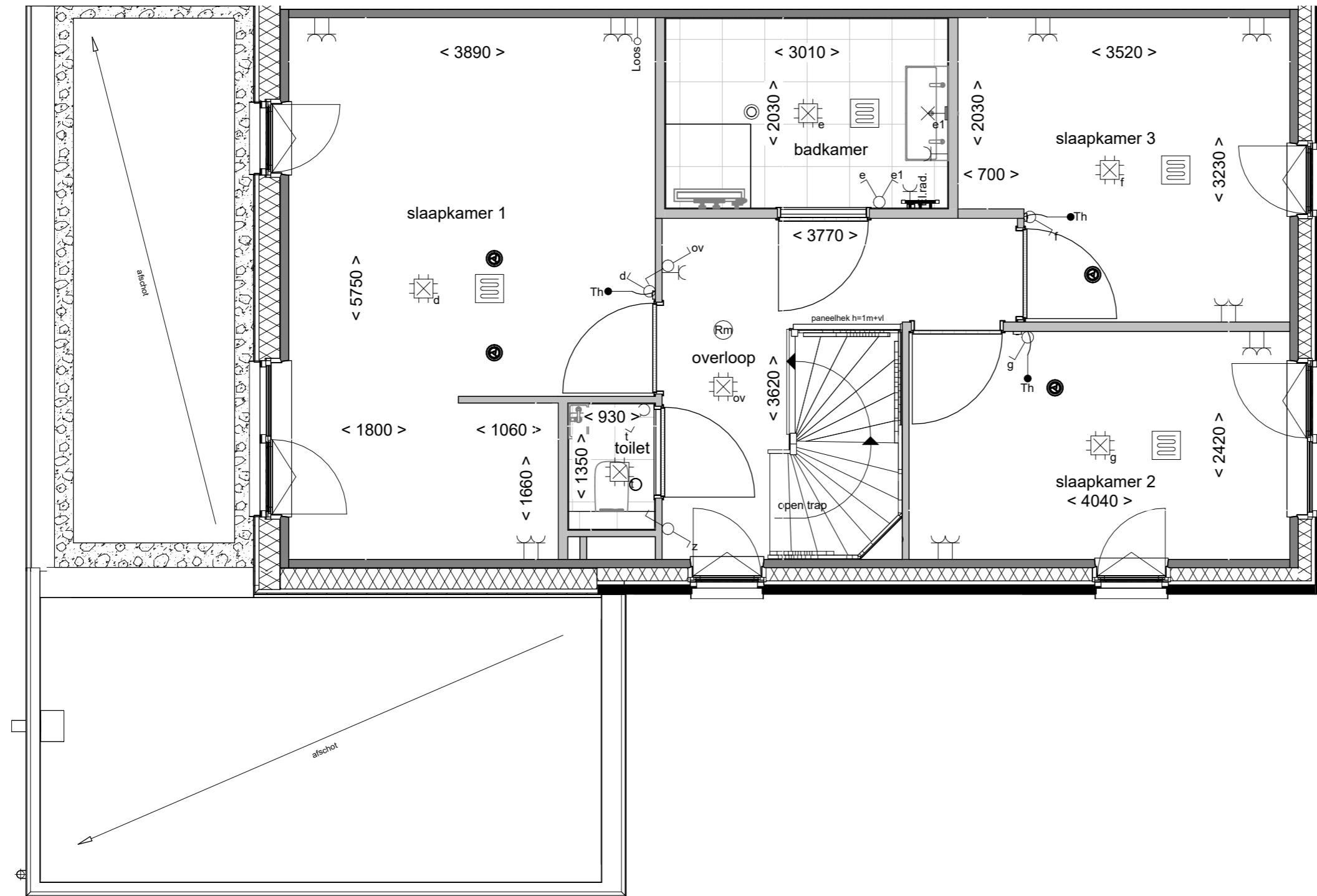

Inloopkast in  
slaapkamer achter

Tekening:

Woningtype: E60

Bouwnummer: -

Optienummer: 1.C.E.32

Bladformaat: A3

Schaal: 1:50

Datum: 21-04-2026

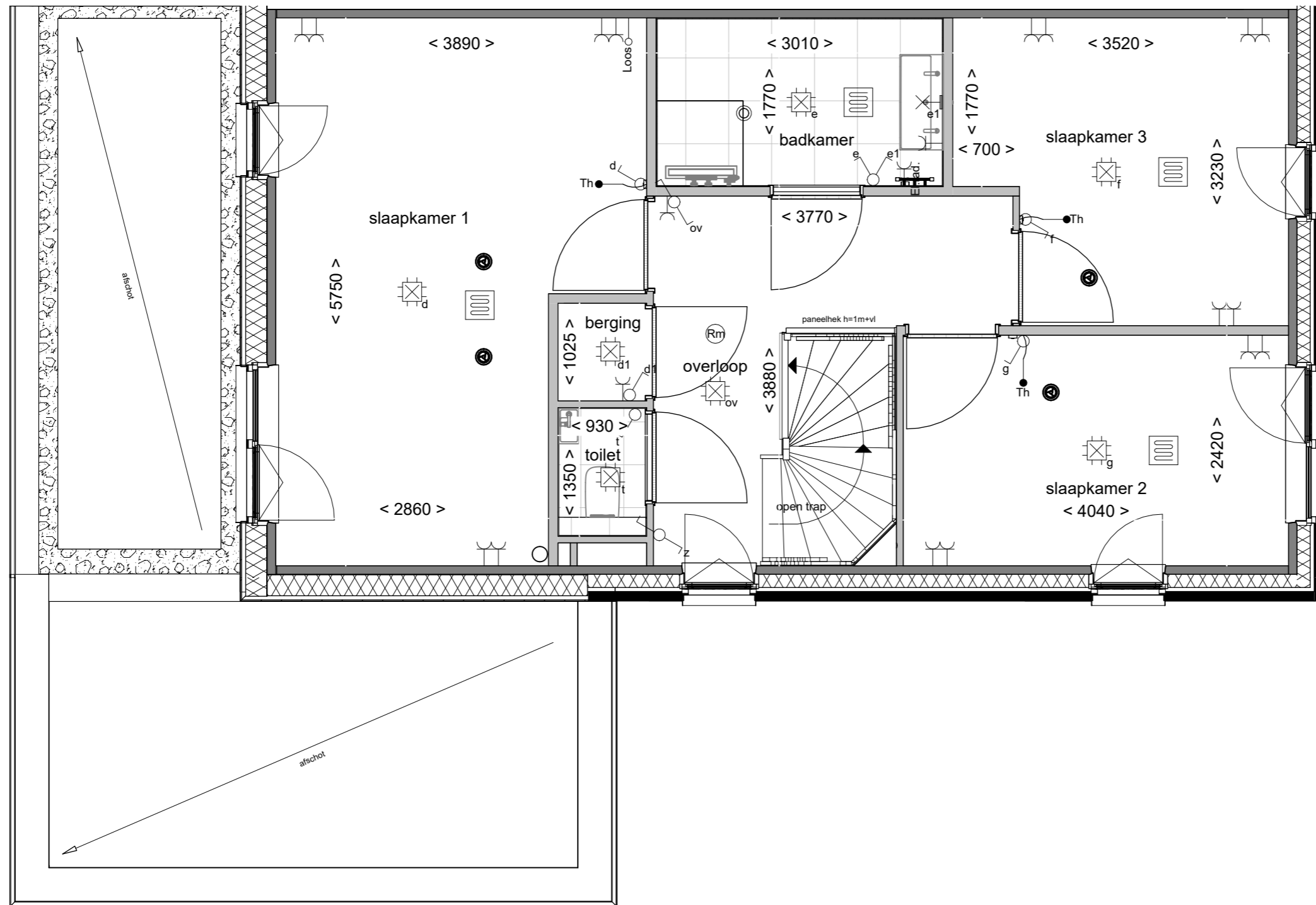

Vaste kast en compacte badk.

Tekening: \_\_\_\_\_

Woningtype: E60

Bouwnummer: -

Optienummer: 1.C.E.34

Bladformaat: A3

Schaal: 1:50

Datum: 21-04-2026

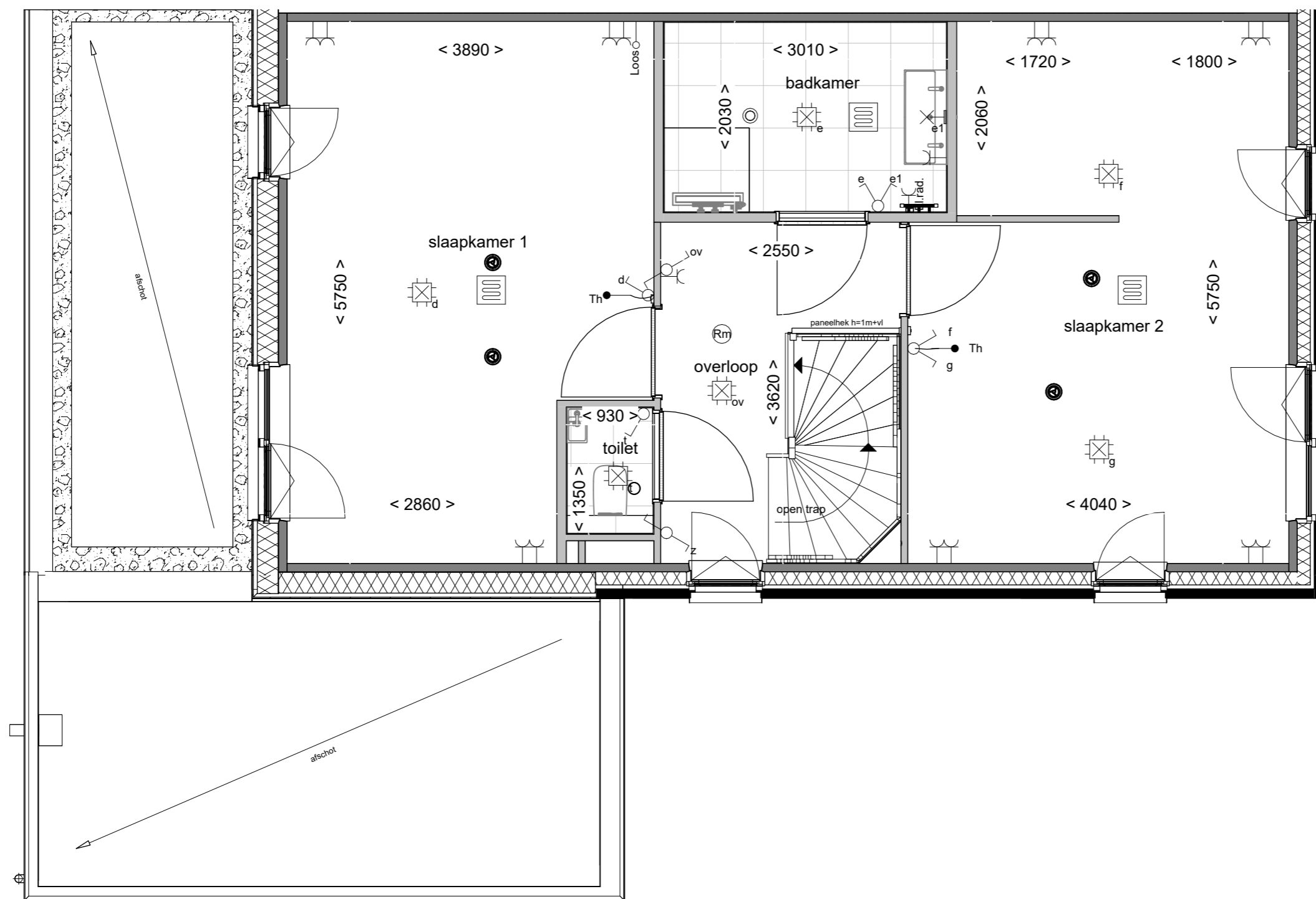

Samenvoegen slpk  
voor met inloopkast

Tekening: \_\_\_\_\_

Woningtype: E60

Bouwnummer: -

Optienummer: 1.C.E.36

Bladformaat: A3

Schaal: 1:50

Datum: 21-04-2026

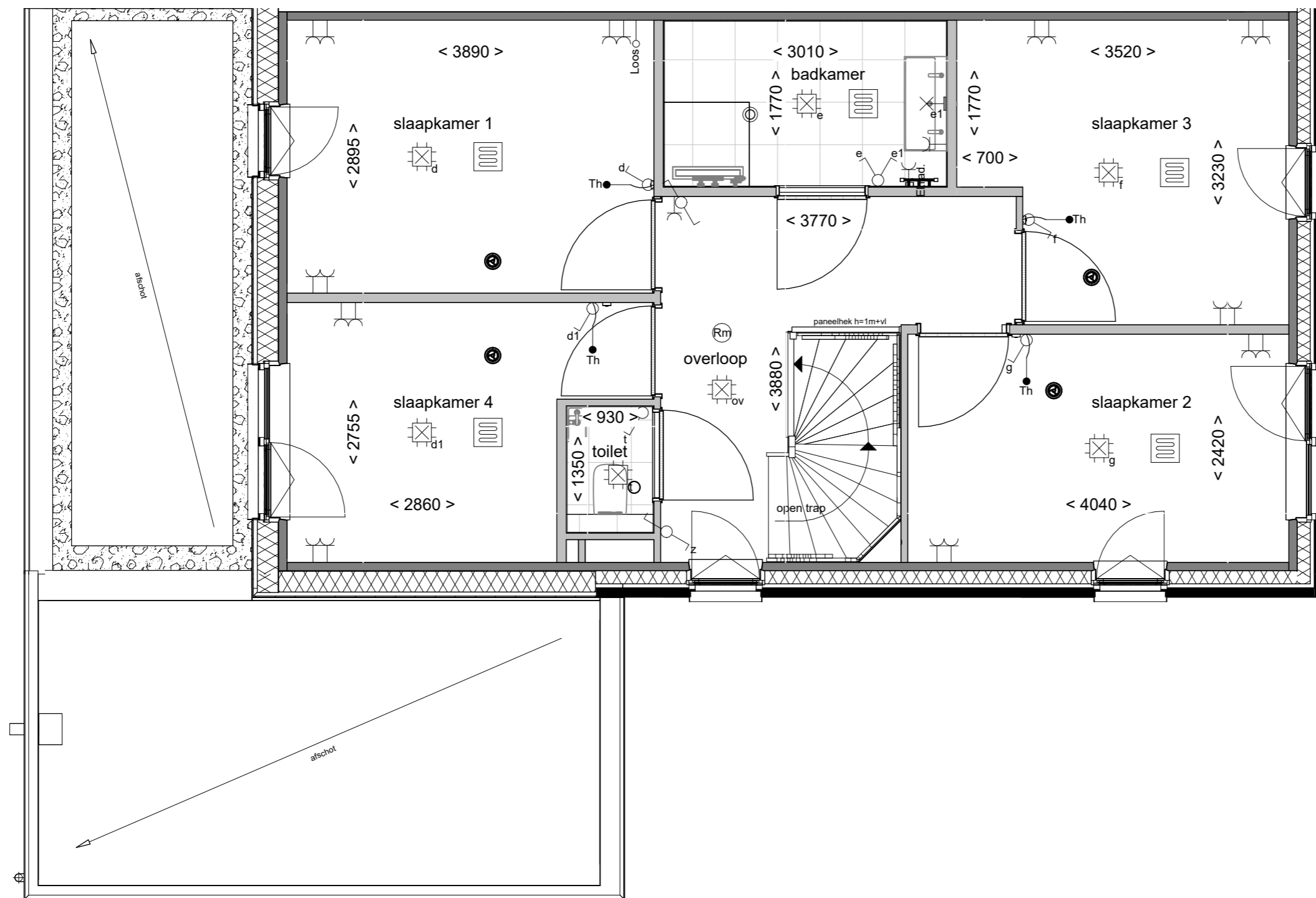

**Wonen aan de Gantel**  
 Compacte badk. met 4 slaapkamers

Tekening: **4 slaapkamers**

Woningtype: **E60**

Bouwnummer: **-**

Optienummer: **1.C.E.38**

Bladformaat: **A3**

Schaal: **1:50**

Datum: **21-04-2026**

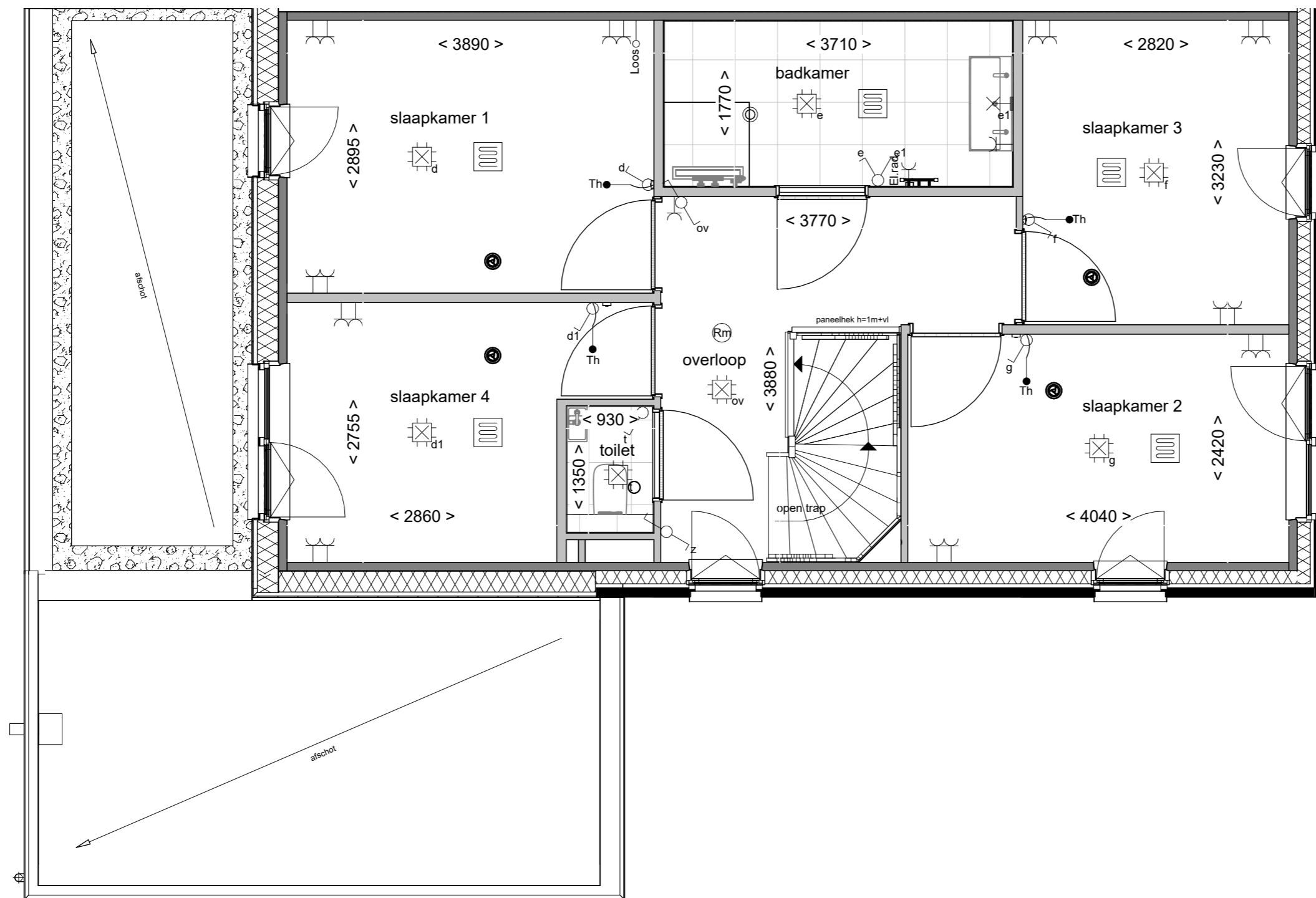

Verl. compacte badk.  
met 4 slpk

Tekening:

Woningtype: E60

Bouwnummer: -

Optienummer: 1.C.E.40

Bladformaat: A3

Schaal: 1:50

Datum: 21-04-2026

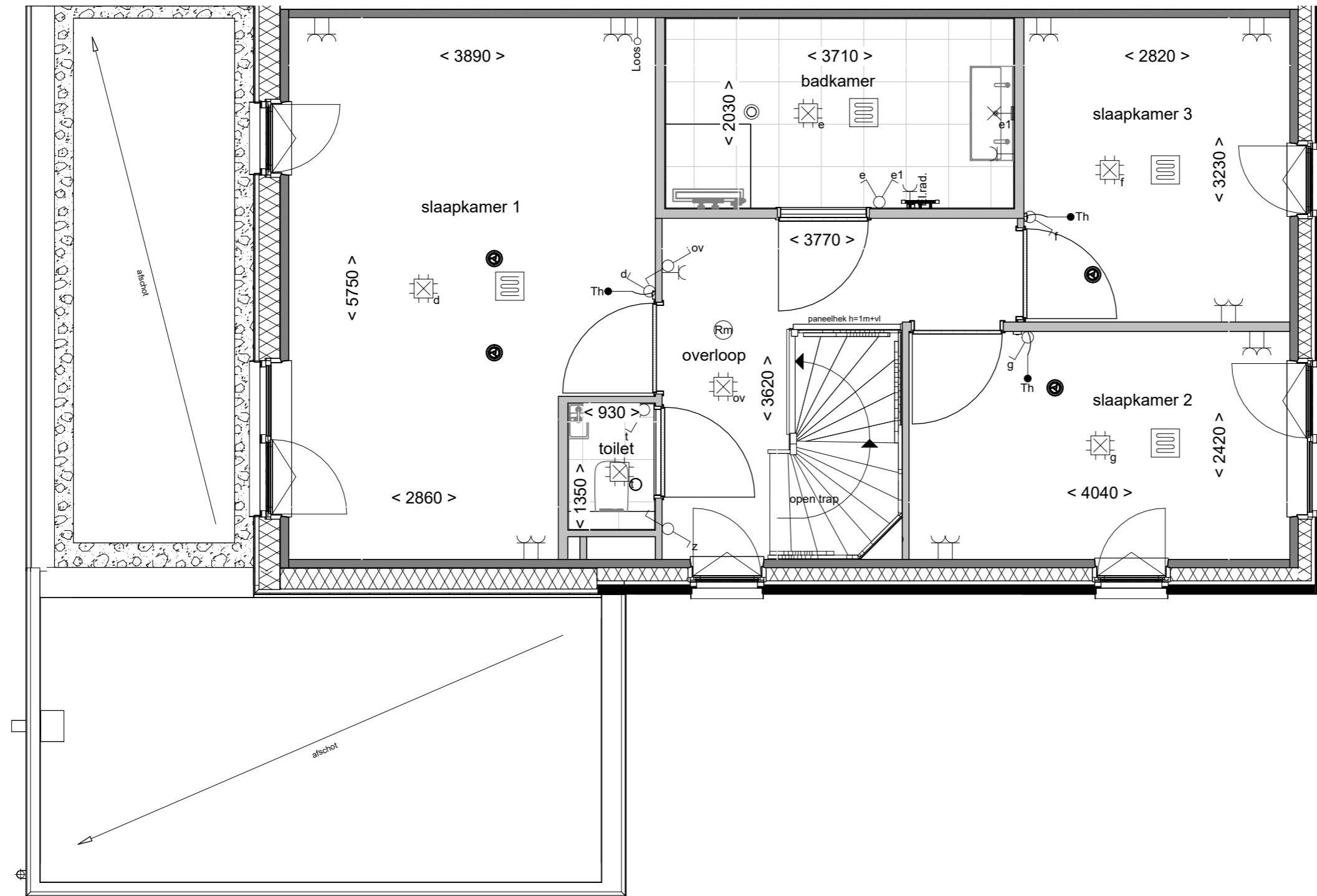

Tekening: **Badkamer vergroten**

Woningtype: **E60**

Bouwnummer: **-**

Optienummer: **1.C.E.42**

Bladformaat: **A3**

Schaal: **1:50**

Datum: **21-04-2026**

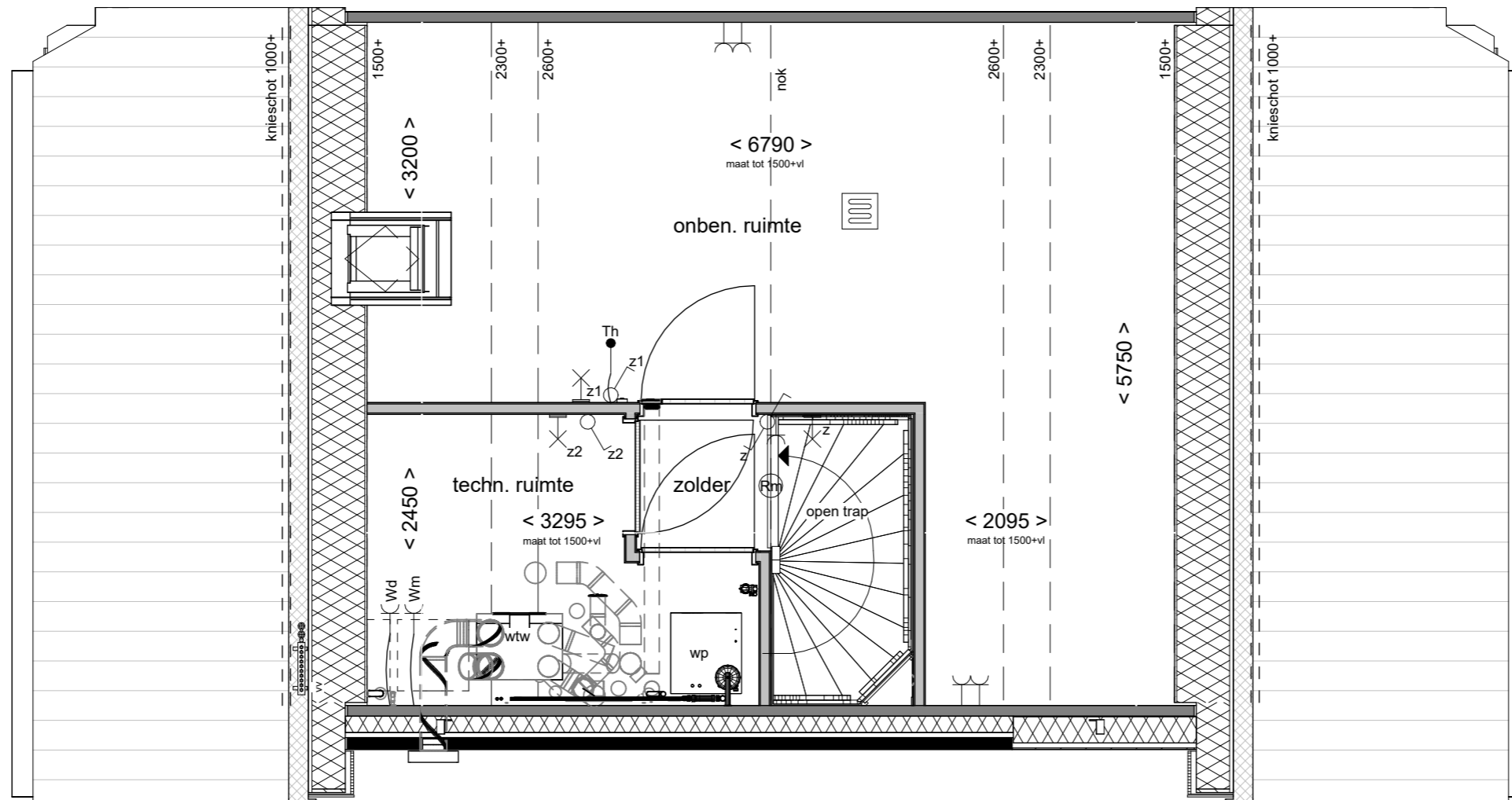

Tekening: Indeling met 1 onben. ruimte

Woningtype: E60

Bouwnummer: -

Optienummer: 1.C.E.74

Bladformaat: A3

Schaal: 1:50

Datum: 21-04-2026

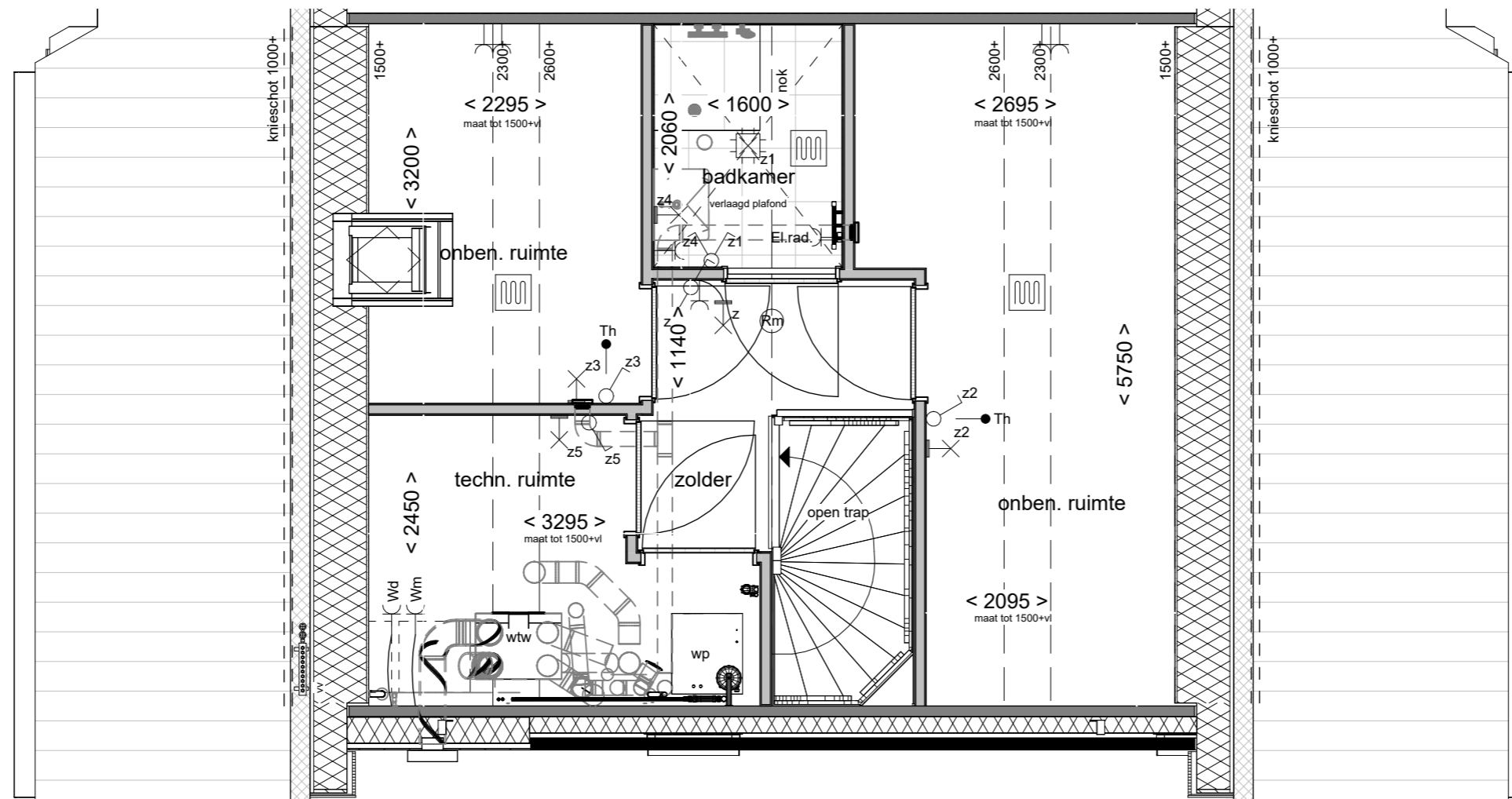

**Wonen aan  
de Gantel**

Tekening: **Indeling 2 ruimten en badkamer**

Woningtype: **E60**

Bouwnummer: **-**

Optienummer: **1.C.E.78**

Bladformaat: **A3**

Schaal: **1:50**

Datum: **21-04-2026**

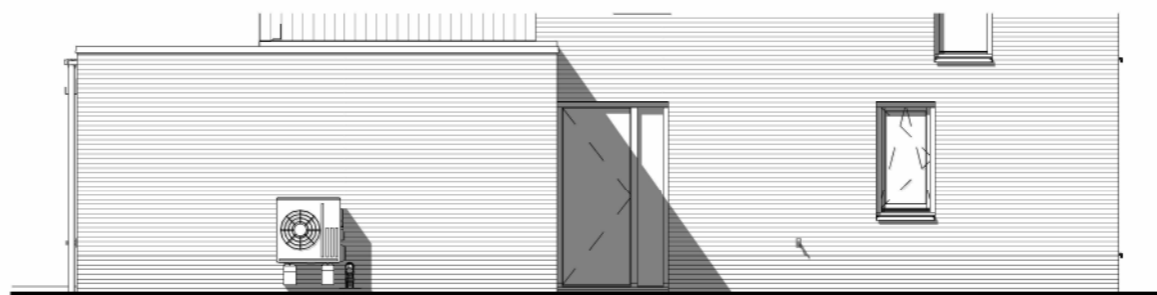
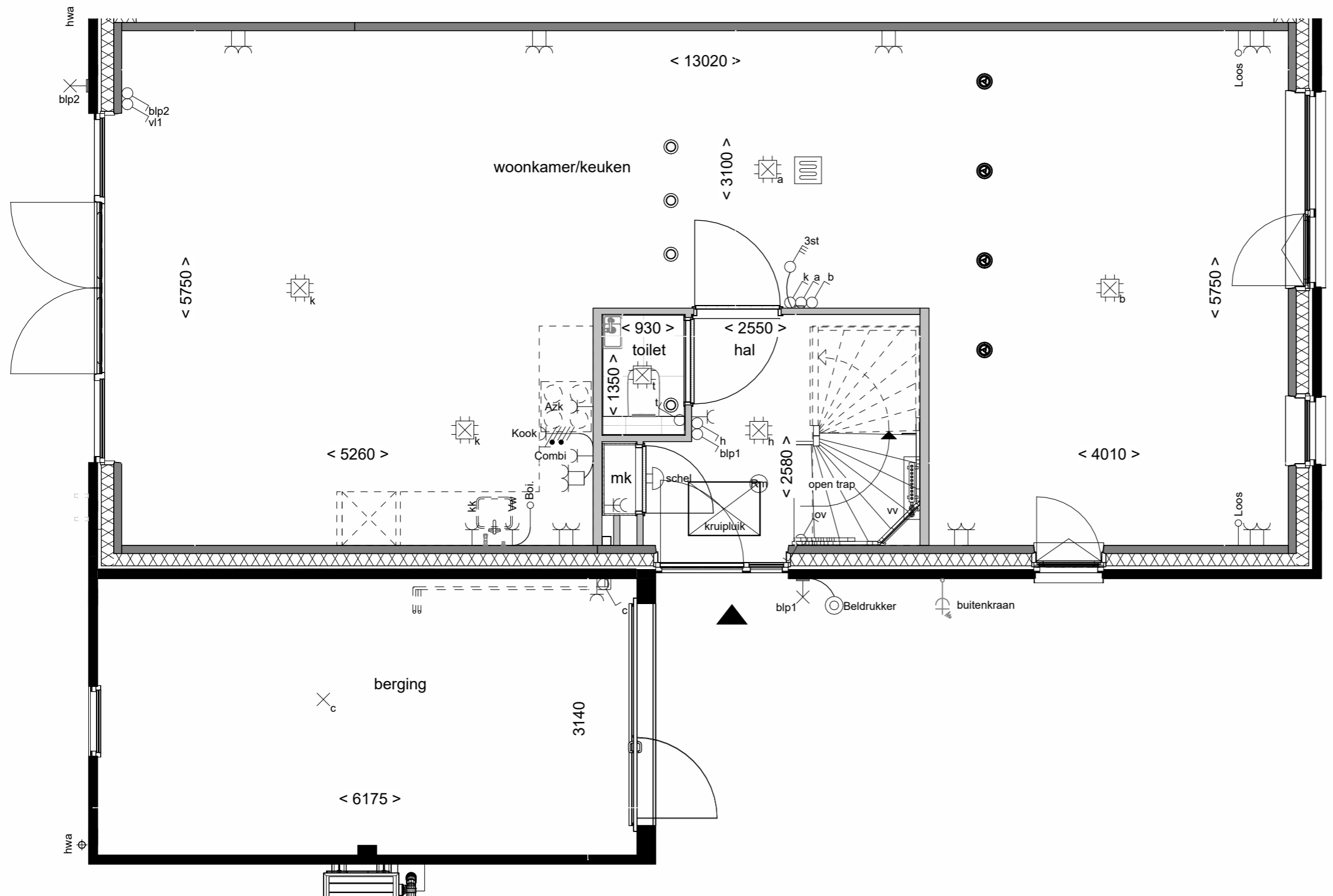

Linkerzijgevel schaal 1:100



vorstvrij buitenkraan  
naast voordeur

Tekening:

Woningtype: E60

Bouwnummer: 02-07,10-13,16,17

Optienummer: 2.K.0.40

Bladformaat: A3

Schaal: 1:50 / 1:100

Datum: 21-04-2026

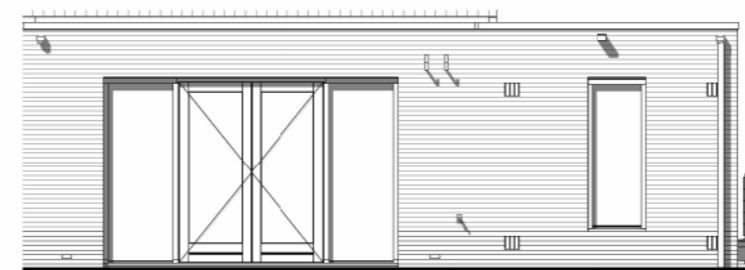
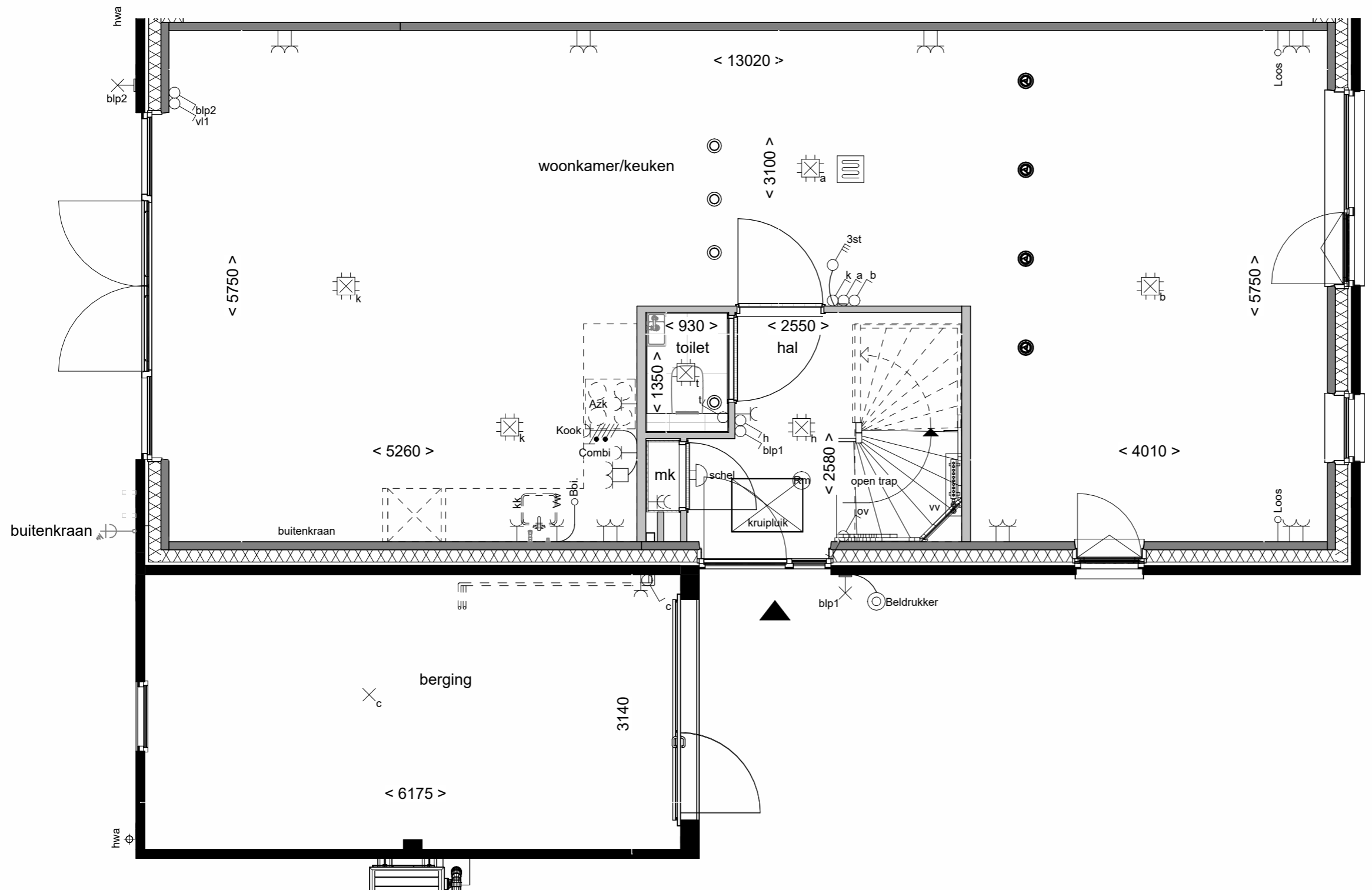

Achtergevel schaal 1:100



vorstvrij buitenkraan  
achter

Tekening:	
Woningtype:	E60
Bouwnummer:	02-07,10-13,16,17
Optienummer:	2.K.0.44
Bladformaat:	A3
Schaal:	1:50 / 1:100
Datum:	21-04-2026

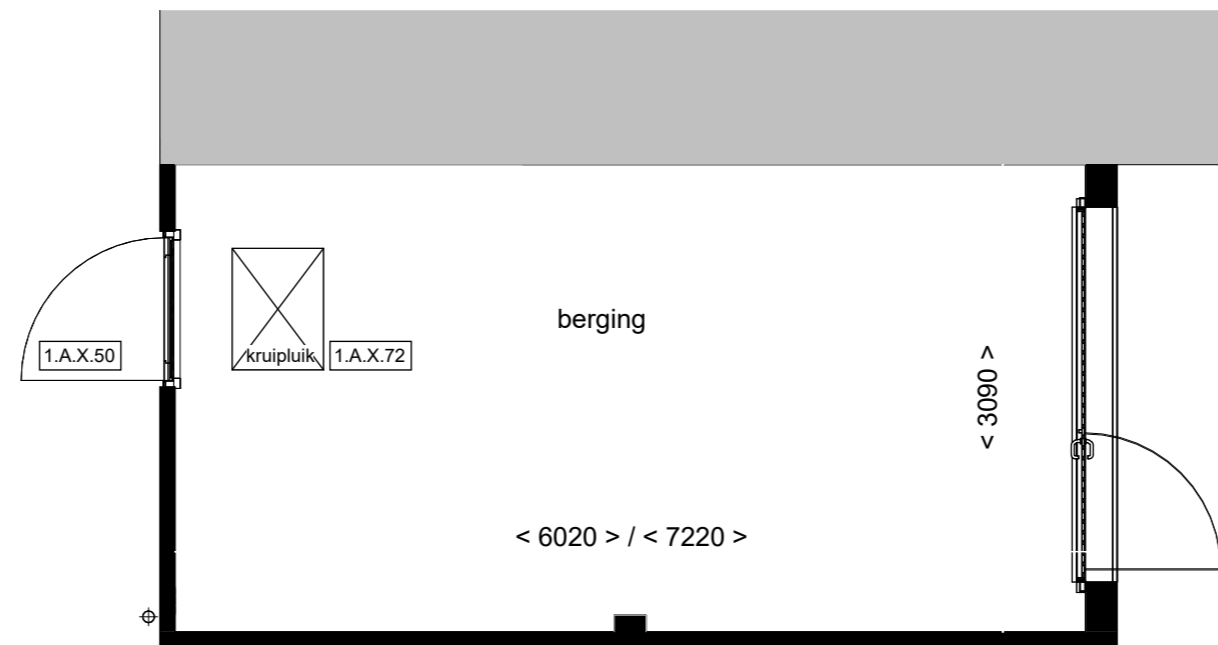

**Wonen aan  
de Gantel**

Kruipluik in de  
berging

Tekening:

Woningtype: E60/F60/F60+/F60D

Bouwnummer: 1 t/m 20

Optienummer: 1.A.X.50 / 1.A.X.72

Bladformaat: A3

Schaal: 1 : 50

Datum: 21-04-2026

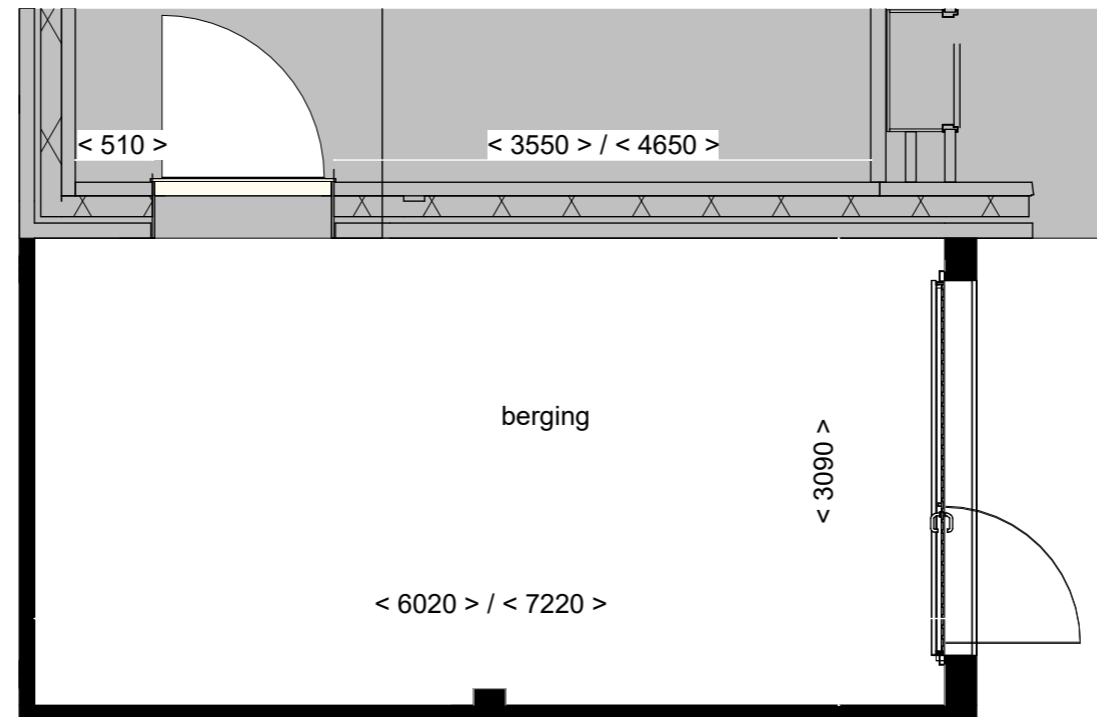

**Wonen aan  
de Gantel**

Tekening: Buitendeur tussen woning en berging

Woningtype: E60/F60/F60+

Bouwnummer: 1 t/m 19

Optienummer: 1.A.X.74 B

Bladformaat: A3

Schaal: 1 : 50

Datum: 21-04-2026

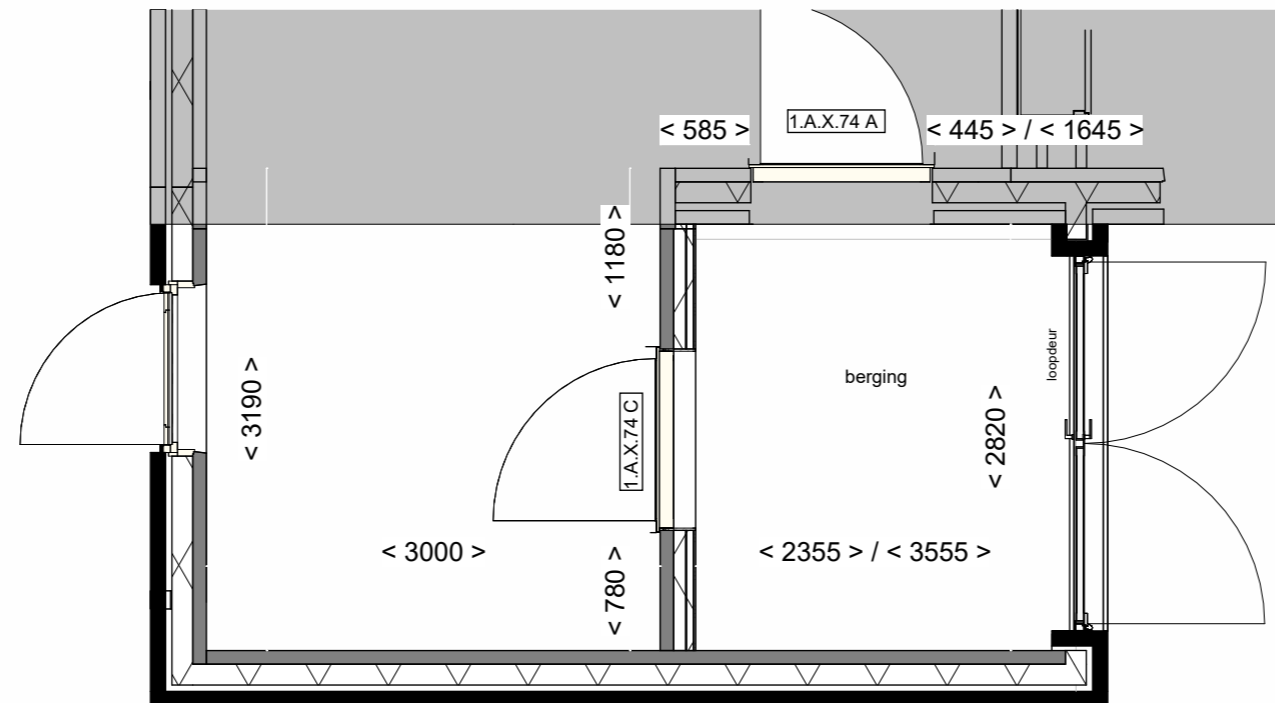

Voorgevel schaal 1:100



Buitendeur tussen  
woning en berging

Tekening:

Woningtype: E60/F60/F60+

Bouwnummer: 1 t/m 19

Optienummer: 1.A.X.74 C

Bladformaat: A3

Schaal: 1:50

Datum: 21-04-2026

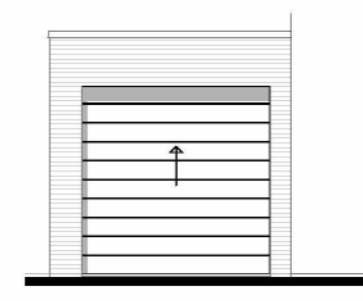
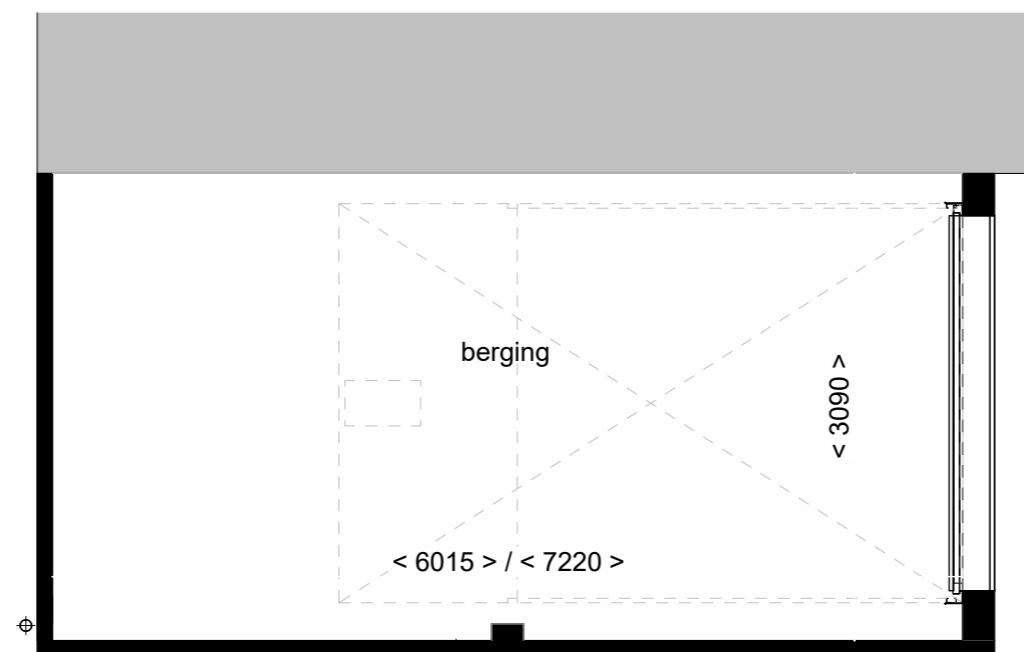

Voorgevel schaal 1:100



**Wonen aan  
de Gantel**

Sectionaaldeur ipv  
kanteldeur

Tekening:

Woningtype: E60/F60/F60+/F60D

Bouwnummer: 1 t/m 20

Optienummer: 1.A.X.80

Bladformaat: A3

Schaal: 1:50

Datum: 21-04-2026

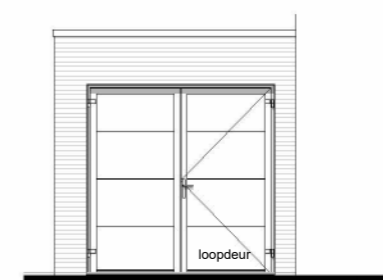
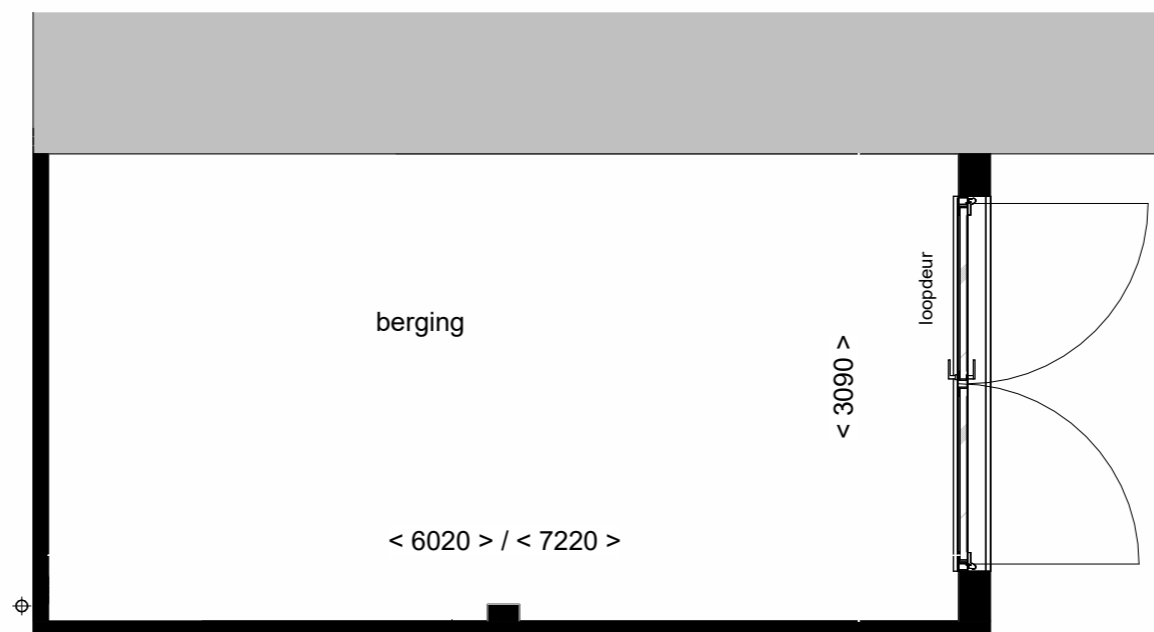

Voorgevel schaal 1:100



**Wonen aan  
de Gantel**

Dubbele

Tekening: openslaande deuren

Woningtype: E60/F60/F60+/F60D

Bouwnummer: 1 t/m 20

Optienummer: 1.A.X.84

Bladformaat: A3

Schaal: 1:50

Datum: 21-04-2026

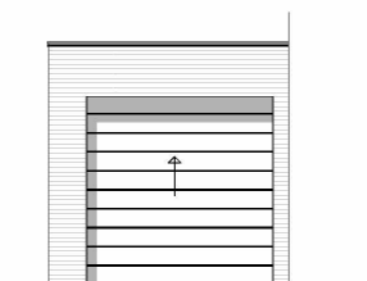
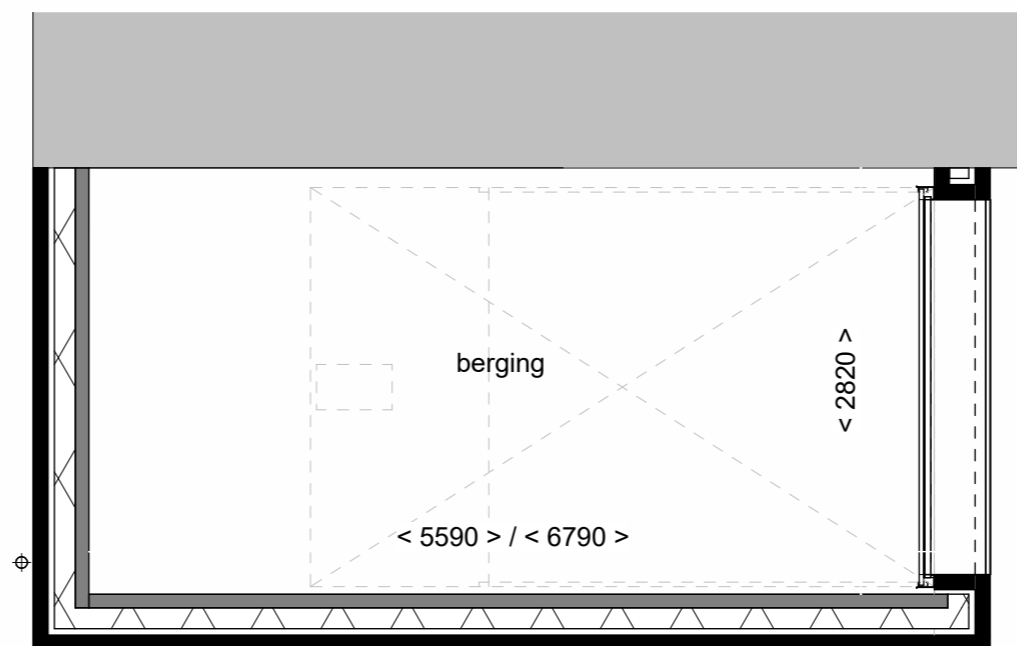

Voorgevel schaal 1:100



Achtergevel schaal 1:100



Tekening: Isoleren berging  
 Woningtype: E60/F60/F60+/F60D  
 Bouwnummer: 01 t/m 20  
 Optienummer: 1.A.X.86  
 Bladformaat: A3  
 Schaal: 1:50  
 Datum: 21-04-2026

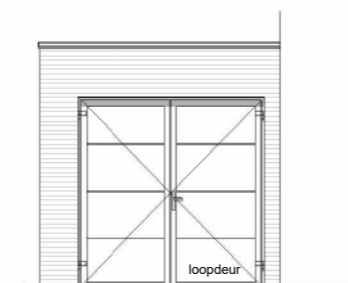
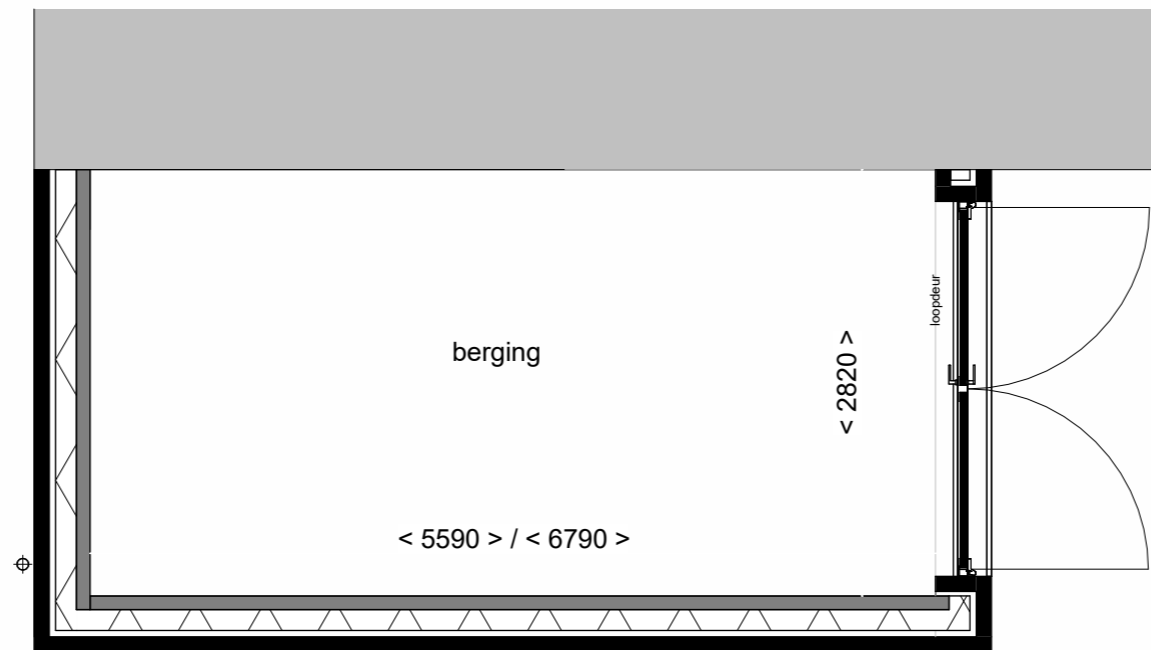

Voorgevel schaal 1:100



Achtergevel schaal 1:100



**Wonen aan  
de Gantel**

Dubbele deuren,  
isoleren

Tekening:

Woningtype: E60/F60/F60+/F60D

Bouwnummer: 1 t/m 20

Optienummer: 1.A.X.94

Bladformaat: A3

Schaal: 1:50

Datum: 21-04-2026