

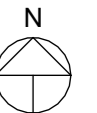

Renvooi

-  - entree woongebouw
-  - erfgrans
-  - parkeervak eigen terrein
-  - parkeervak openbaar
-  - houten vlonder
-  - pergola
-  - haag laag
-  - haag hoog
-  - water
-  - openbaar groen
-  - wandelpad houtsnippers
-  - voetpad
-  - inrit
-  - straat
-  - talud
-  - boom, positie in overleg met koper
-  - indicatie positie riolering
-  - zone erfdienstbaarheid
-  - klinkerbestrating

parkeerplekken en posities bomen indicatief



Tekening: **Situatie totaal**

Woningtype: **E60,E60D,F60,F60+**

Bouwnummer: **1 t/m 31**

Bladnummer: **VT-S-00**

Bladformaat: **A3**

Schaal: **1:750**

Datum: **21-04-2026**



- ### Renvooi
- entree woongebouw
 - erfgrans
 - parkeervak eigen terrein
 - parkeervak openbaar
 - houten vlonder
 - pergola
 - haag laag
 - haag hoog
 - water
 - openbaar groen
 - wandelpad houtsnippers
 - voetpad
 - straat
 - talud
 - boom, positie in overleg met koper
 - indicatie positie riolering
 - zone erfdienstbaarheid
 - klinkerbestrating

parkeerplekken en posities bomen indicatief

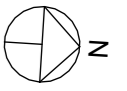

Tekening: **Situatie bnr. 1-5**

Woningtype: **F60, E60, E60D**

Bouwnummer: **1, 2, 3, 4, 5**

Bladnummer: **VT-S-01**

Bladformaat: **A3**

Schaal: **1:200**

Datum: **21-04-2026**

Renvooi materialen



dakpan antracietgrijs



metselwerk kleur grijswit gesinterd
code A: EN1166 WF WS



metselwerk kleur bruin nuance
code B: HM1106 WF WS



metselwerk kleur bruin caramel
code C: EN1165 WF WS



gevelbetimmering vuren vergrijsd

Renvooi bouwkundig



entree woning



metselwerk



isolatie



dragende wand



niet dragende binnenwand

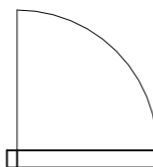

buitendeur

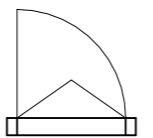

draairaam

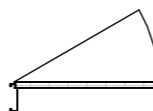

binnendeurkozijn (met bovenlicht)

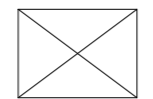

kruipluik

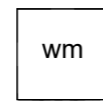

opstelplaats wasmachine

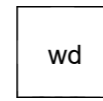

opstelplaats wasdroger



opstelplaats koelkast

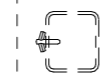

principe opstelling keukenblok

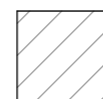
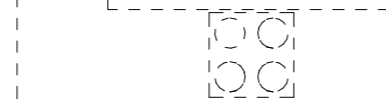

onbenoemde ruimte volgens krijtstreepmethode

Renvooi installaties



aansluitpunt licht, wand



centraaldoos met lichtpunt



armatuur aan de wand



rookmelder



aansluitpunt niet bedraad / loos



aansluitpunt bedraad data, niet afgemonteerd



bedrukker



schel



schakelaar, 1-polig



werkschakelaar tbv PV-panelen



driestandenschakelaar tbv wtw



schakelaar, wissel



schakelaar, serie



pulsschakelaar tbv warmteterugwinunit



wandcontactdoos 1-voudig met beschermingscontact



wandcontactdoos 2-voudig met beschermingscontact



thermostaatleiding, bedraad



wandcontactdoos tbv warmteterugwinunit



mechanische ventilatie-unit incl. warmteterugwinunit



warmtepomp



inblaasventiel mechanische ventilatie



afzuigventiel mechanische ventilatie



verdelers vloerverwarming



ruimte vzv vloerverwarming



elektrische radiator

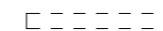

kanalen in het zicht



doucheput



lijngoot douche



buitenkraan

Disclaimer

De op deze tekeningen aangegeven maten zijn circa maten in millimeters en tussen de wanden / vloeren gemeten, waarbij geen rekening is gehouden met enige wandafwerking, plinten, aftimmering, etc. In verband met de nauwkeurige uitwerking van details, constructie, maatvoering, materialen e.d. kunnen er kleine afwijkingen ontstaan ten opzichte van de nu vermelde gegevens. Deze geringe afwijkingen geven geen aanleiding tot verrekening. Aan de op deze tekening aangegeven maten kunnen derhalve geen rechten worden ontleend. De op deze tekeningen aangegeven maatvoering is niet geschikt voor opdrachten aan derden door koper(s). De posities van aansluitingen en installatie onderdelen zijn indicatief op tekening aangegeven. De exacte aantallen en posities zullen na berekening in het werk door de installateurs worden bepaald en kunnen afwijken van deze tekening.



**Wonen aan
de Gantel**

Tekening: **Renvooi**

Woningtype: **E60 / F60 / F60+**

Bouwnummer: **1 t/m 31**

Bladnummer: **VT-0-00c**

Bladformaat: **A3**

Schaal: **1 : 50**

Datum: **21-04-2026**



Vorgevel

Type: E60D
bnr: 2

Type: E60
bnr: 3

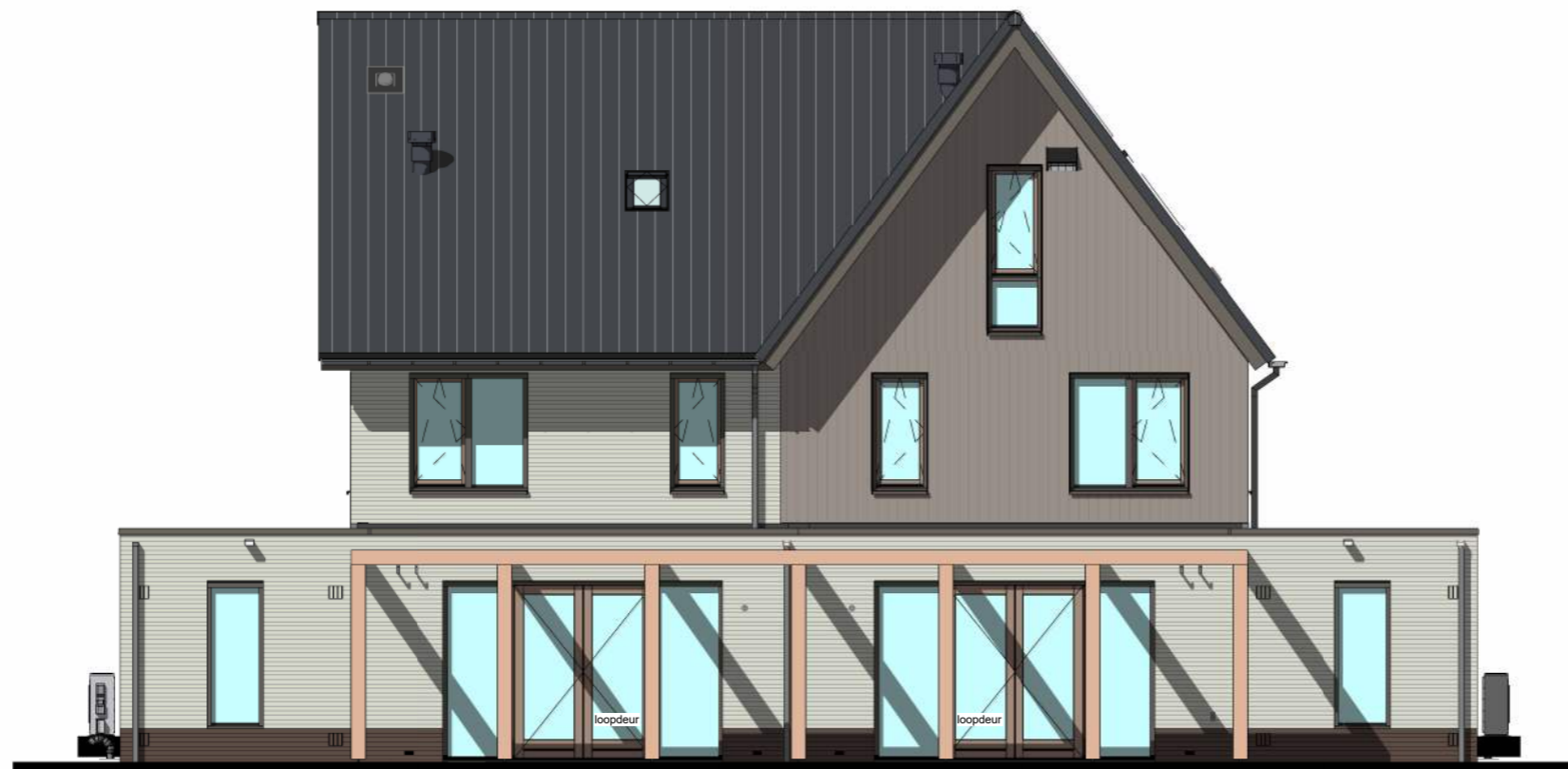

Achtergevel

Type: E60
bnr: 3

Type: E60D
bnr: 2



Wonen aan
de Gantel

Tekening: Gevels blok 2

Woningtype: E60D / E60

Bouwnummer: 2 / 3

Bladnummer: VT-02-00a

Bladformaat: A3

Schaal: 1 : 100

Datum: 21-04-2026

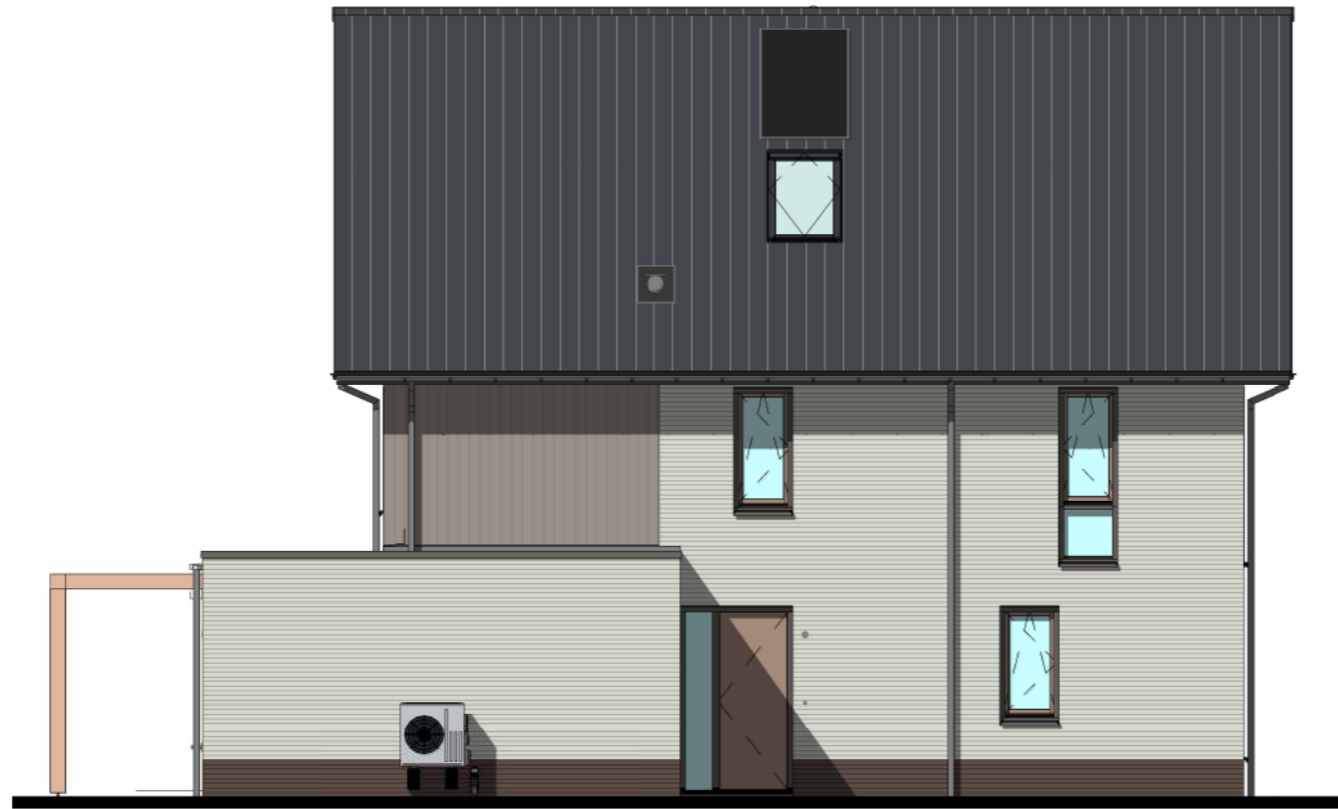

Linker zijgevel

Type: E60D
bnr: 2



Rechter zijgevel

Type: E60
bnr: 3



Tekening: Zijgevels blok 2

Woningtype: E60D / E60

Bouwnummer: 2 / 3

Bladnummer: VT-02-00b

Bladformaat: A3

Schaal: 1 : 100

Datum: 21-04-2026

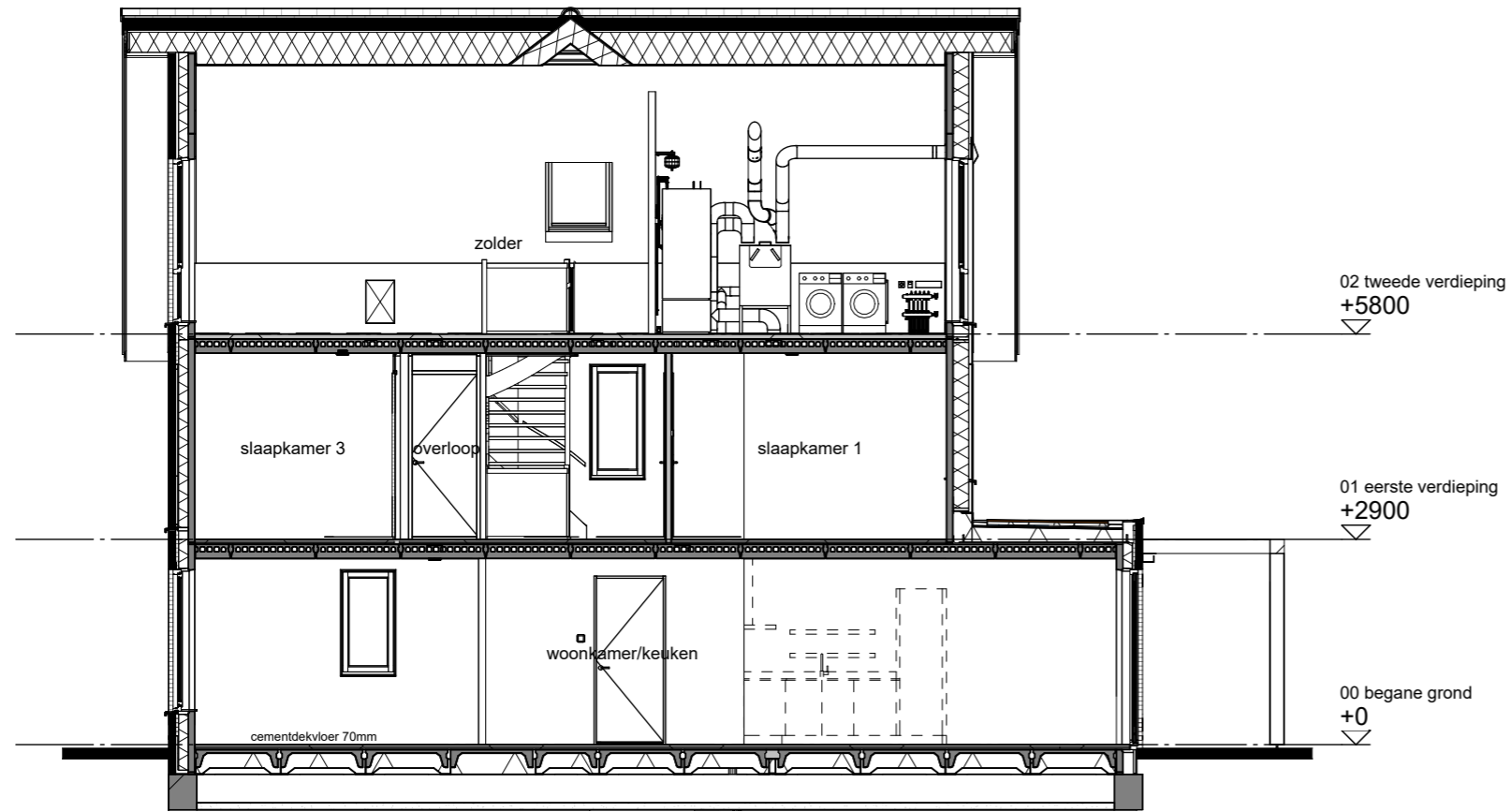

Doorsnede A-A

Type: E60D
bnr: 2

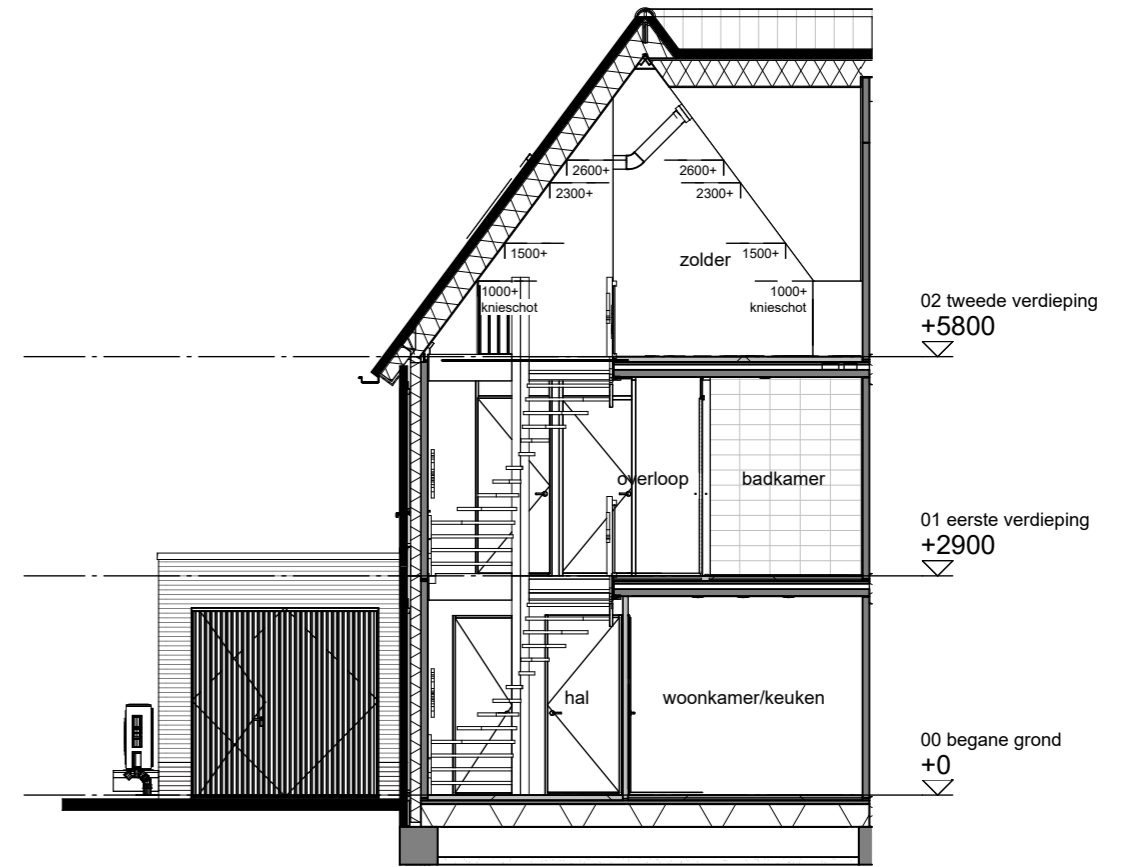

Doorsnede C-C

Type: E60D
bnr: 2

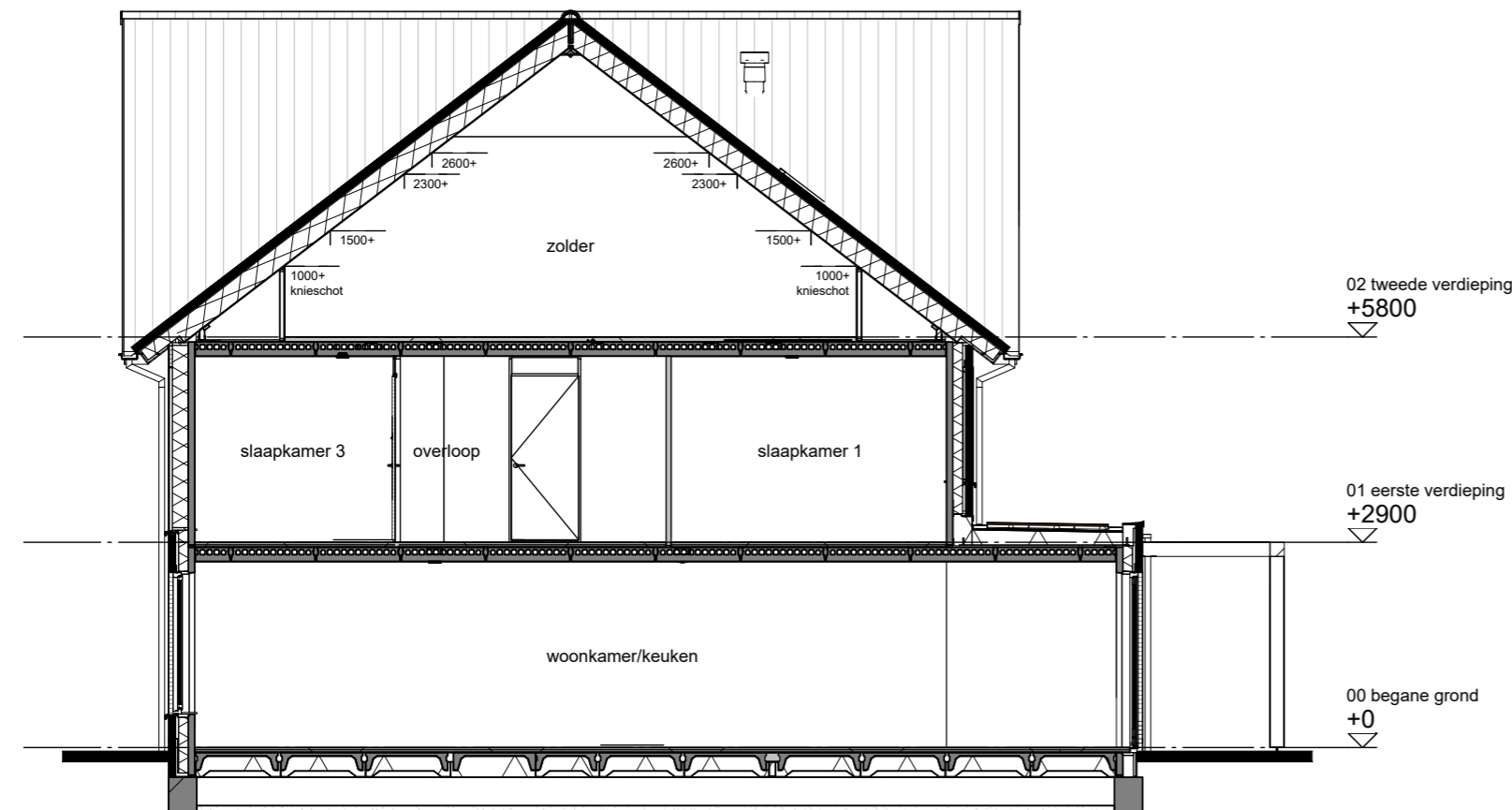

Doorsnede B-B

Type: E60
bnr: 3



Tekening: Doorsn. blok 2

Woningtype: E60D / E60

Bouwnummer: 2 / 3

Bladnummer: VT-02-00c

Bladformaat: A3

Schaal: 1 : 100

Datum: 21-04-2026

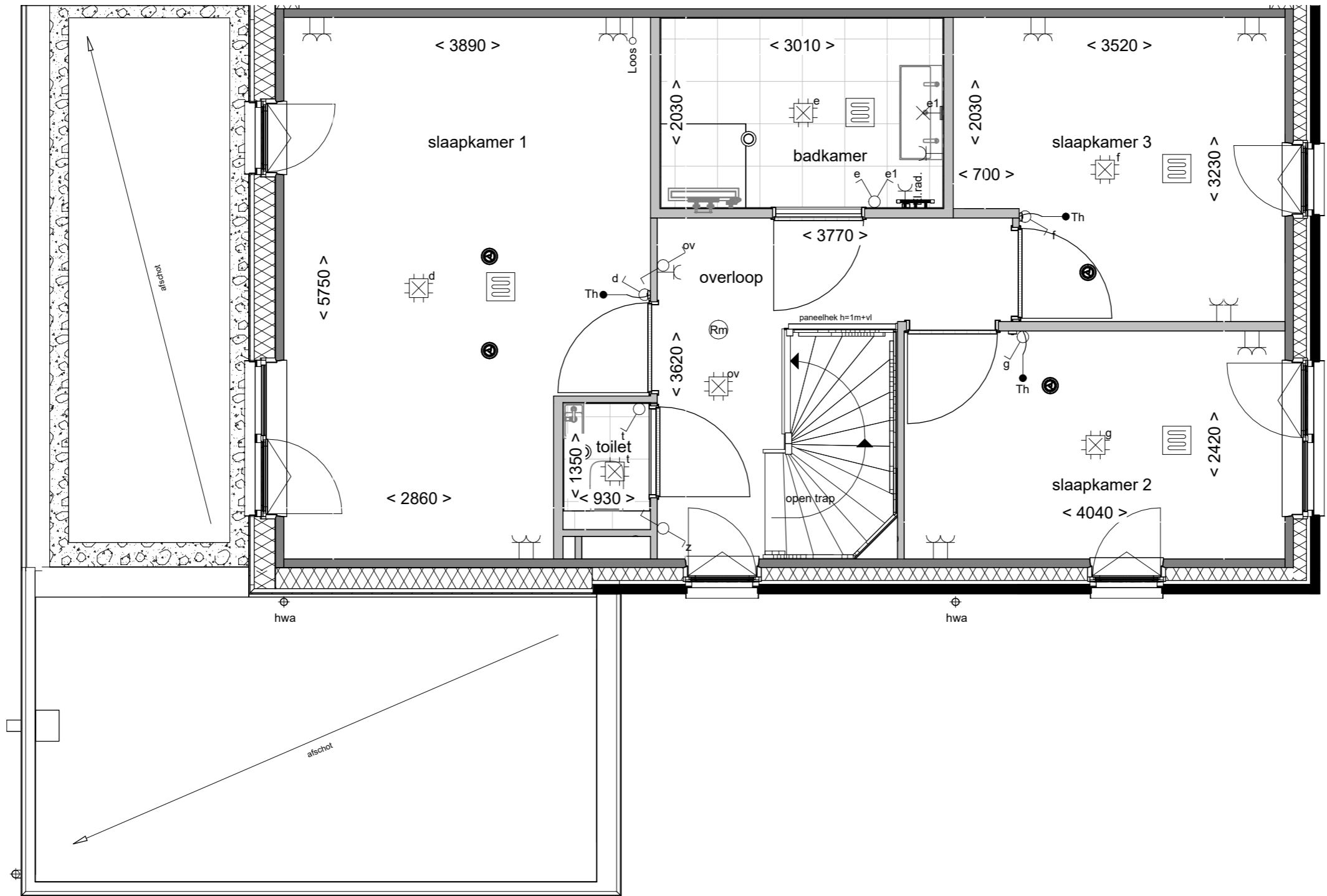

Tekening: **Eerste verdieping**

Woningtype: **E60D**

Bouwnummer: **2**

Bladnummer: **VT-02-02b**

Bladformaat: **A3**

Schaal: **1 : 50**

Datum: **21-04-2026**

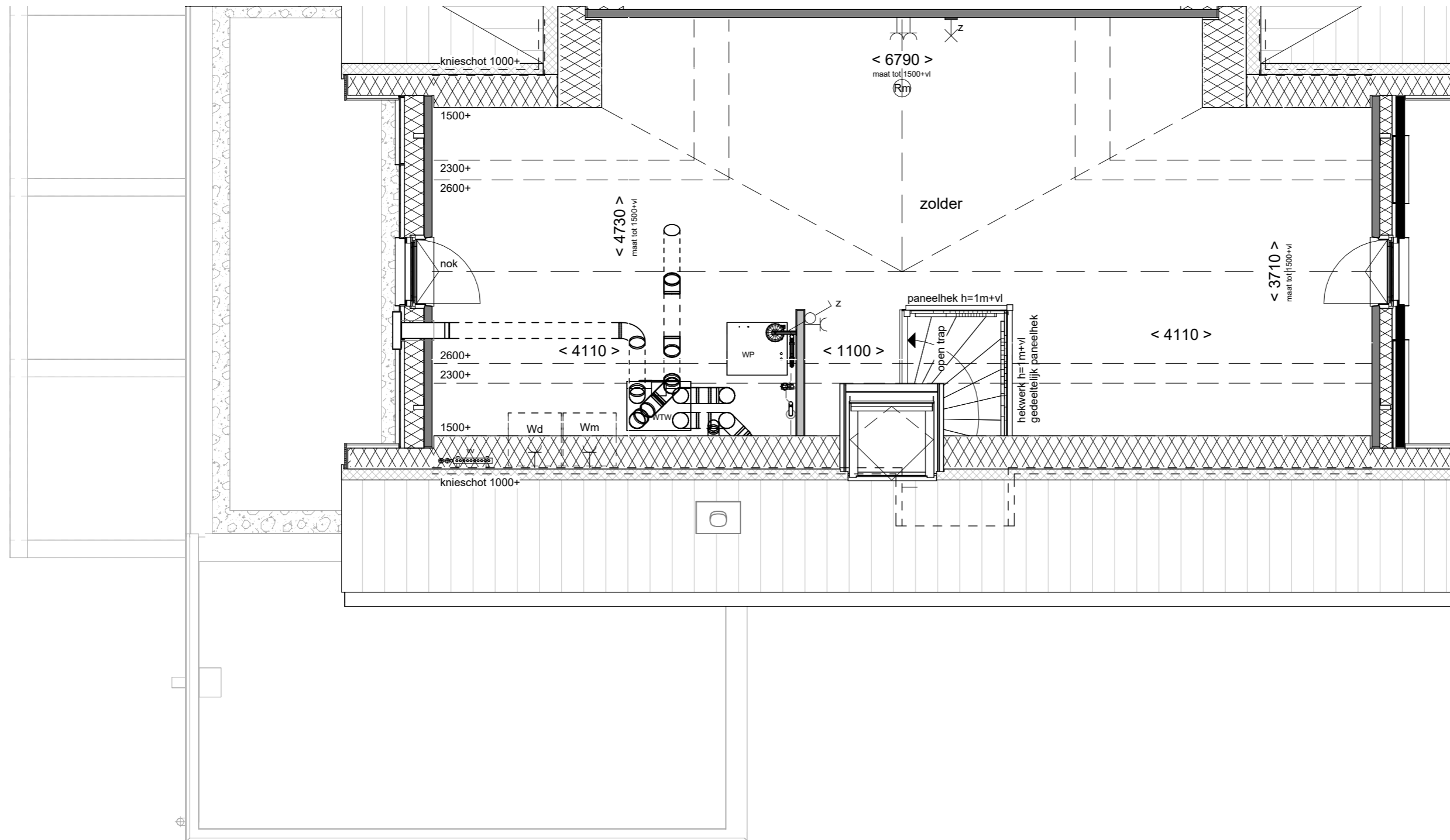

Tekening: **Tweede verdieping**

Woningtype: **E60D**

Bouwnummer: **2**

Bladnummer: **VT-02-02c**

Bladformaat: **A3**

Schaal: **1 : 50**

Datum: **21-04-2026**

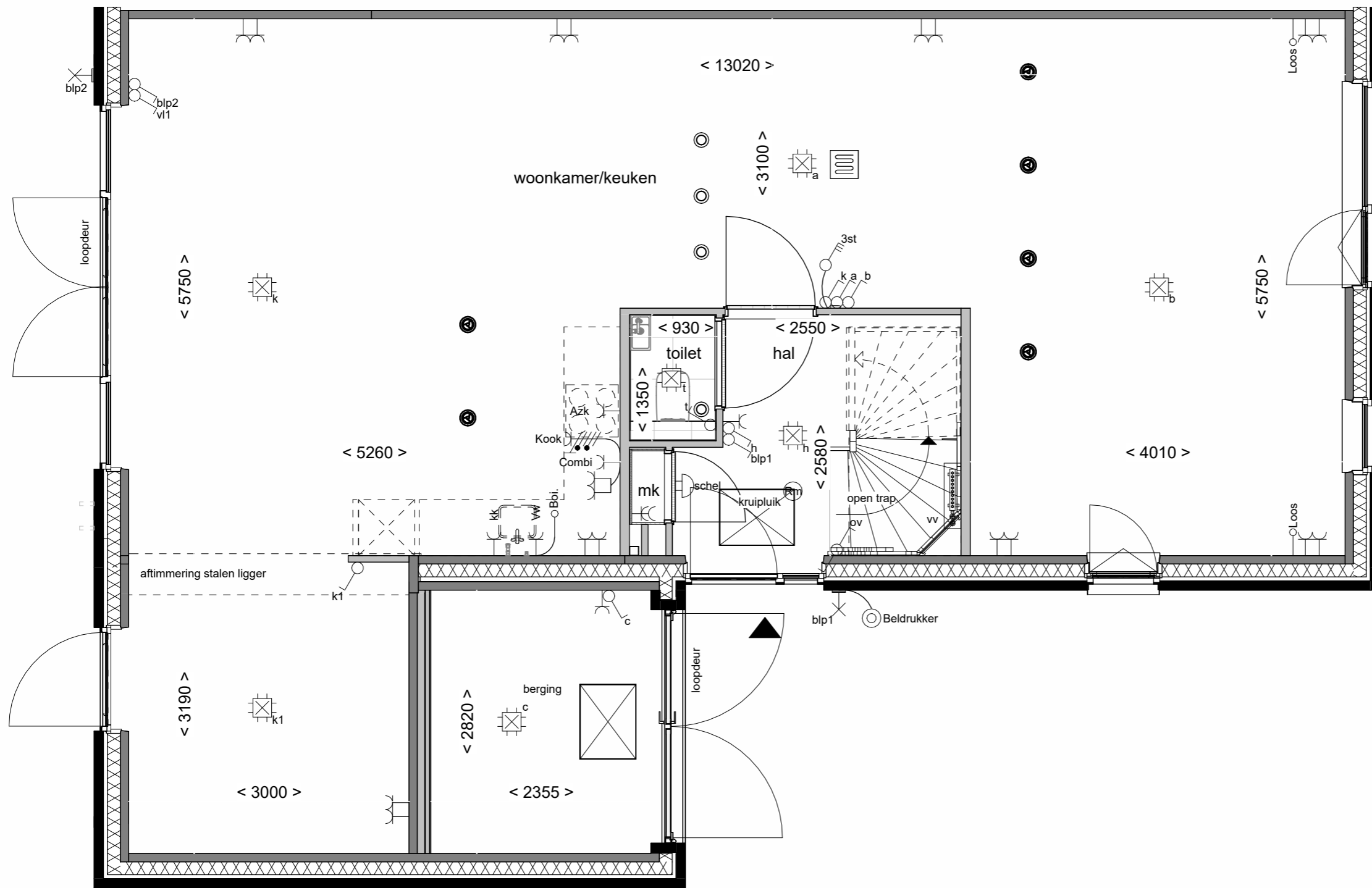

Begane grond

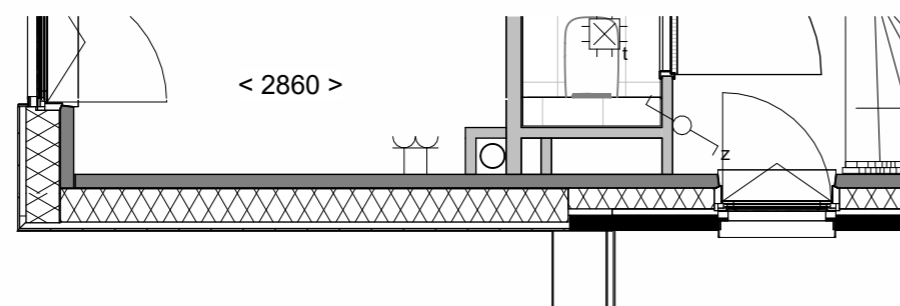

Eerste verdieping (extra schacht)



Achtergevel schaal 1:100



Samenvoegen
berging bij wnk

Tekening:

Woningtype: E60

Bouwnummer: -

Optienummer: 1.A.E.14

Bladformaat: A3

Schaal: 1:50 / 1:100

Datum: 21-04-2026

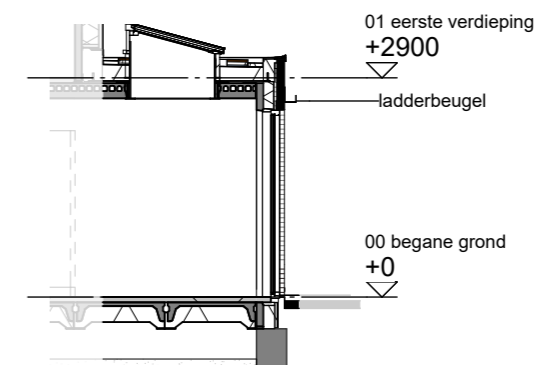
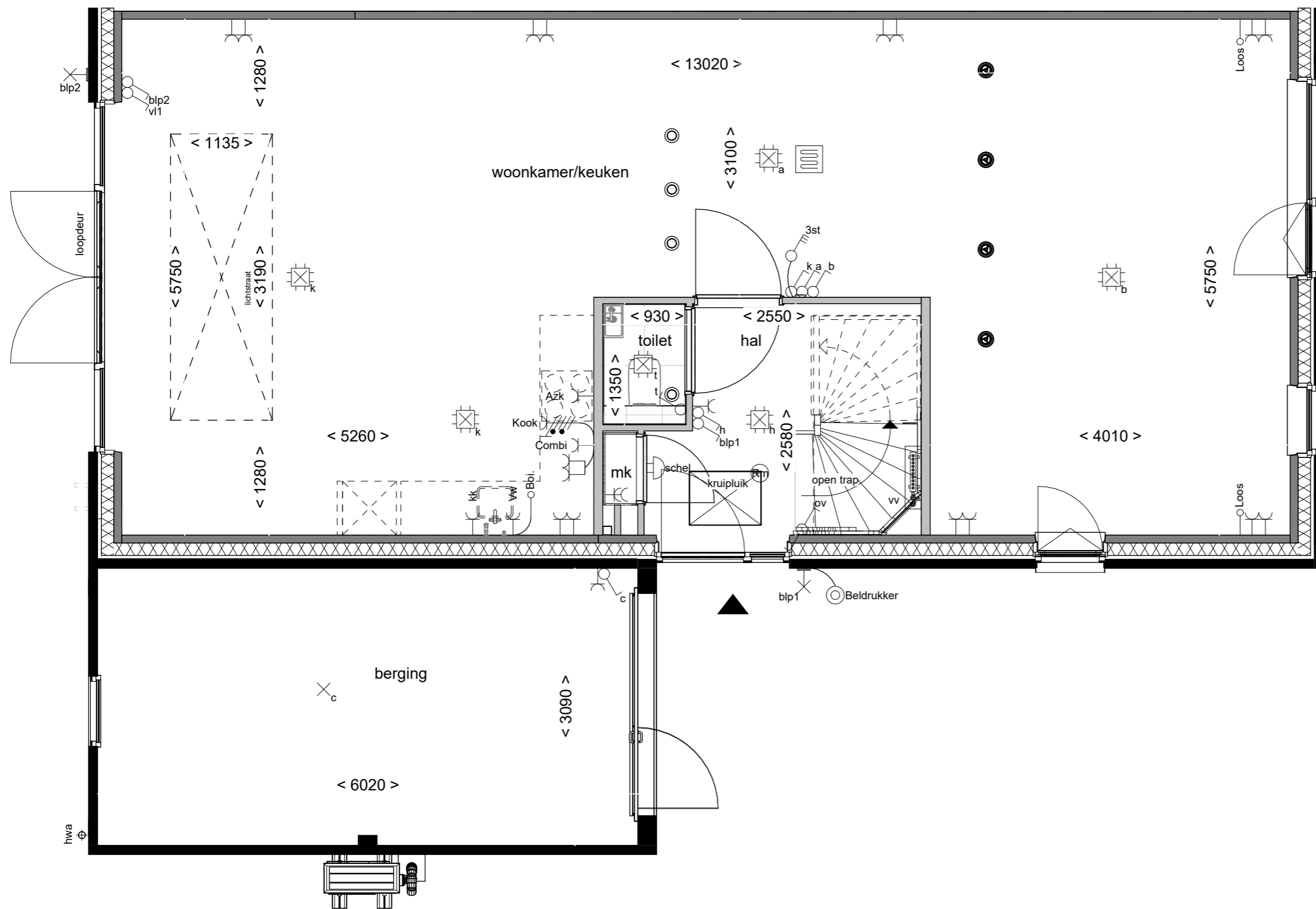

Doorsnede schaal 1:100



Lichtstraat in uitbouw
240cm

Tekening:	Lichtstraat in uitbouw 240cm
Woningtype:	E60
Bouwnummer:	-
Optienummer:	1.B.X.14
Bladformaat:	A3
Schaal:	1:50 / 1:100
Datum:	21-04-2026

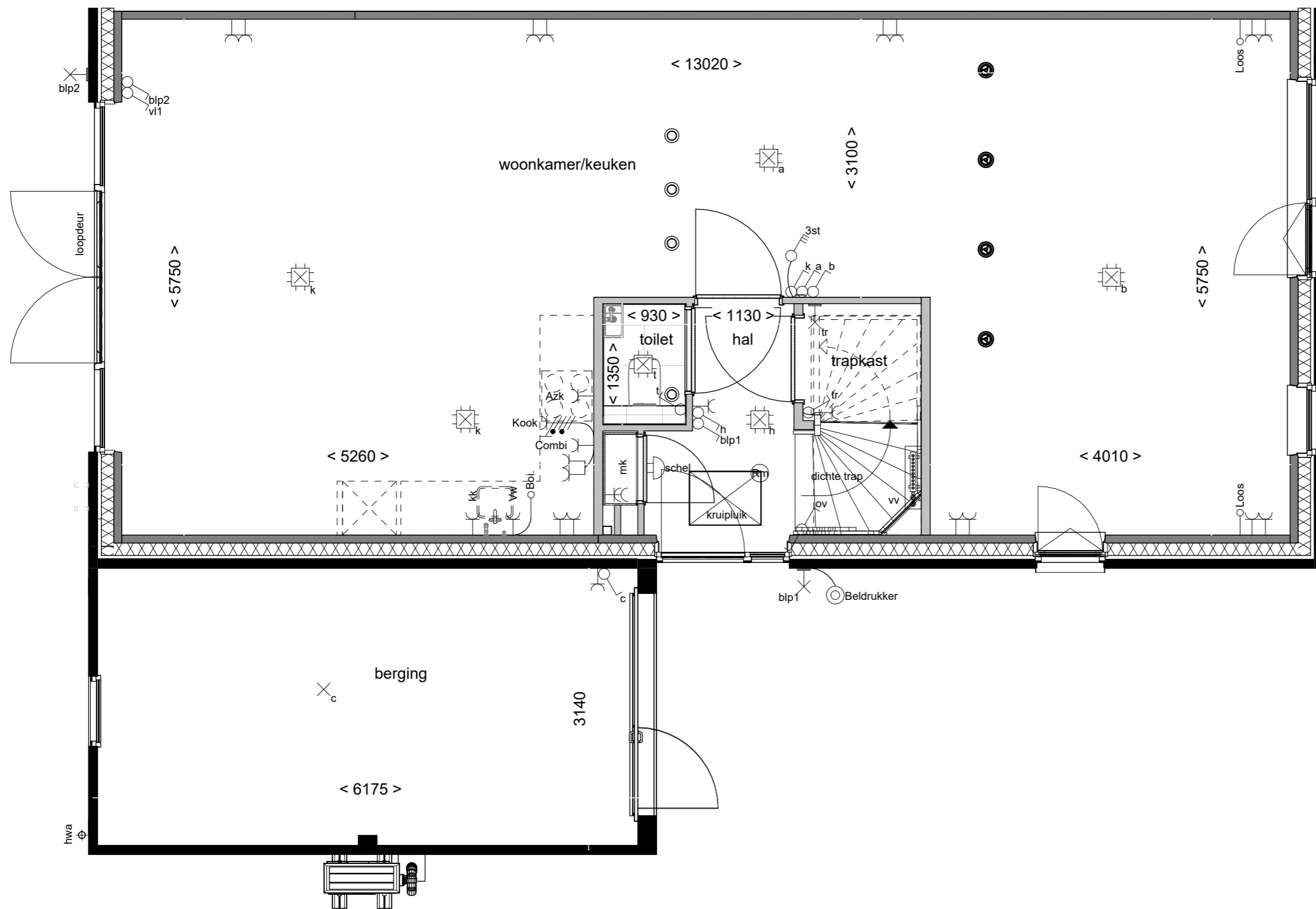

Tekening: Trapkast
 Woningtype: E60
 Bouwnummer: -
 Optienummer: 1.C.E.10
 Bladformaat: A3
 Schaal: 1:50
 Datum: 21-04-2026

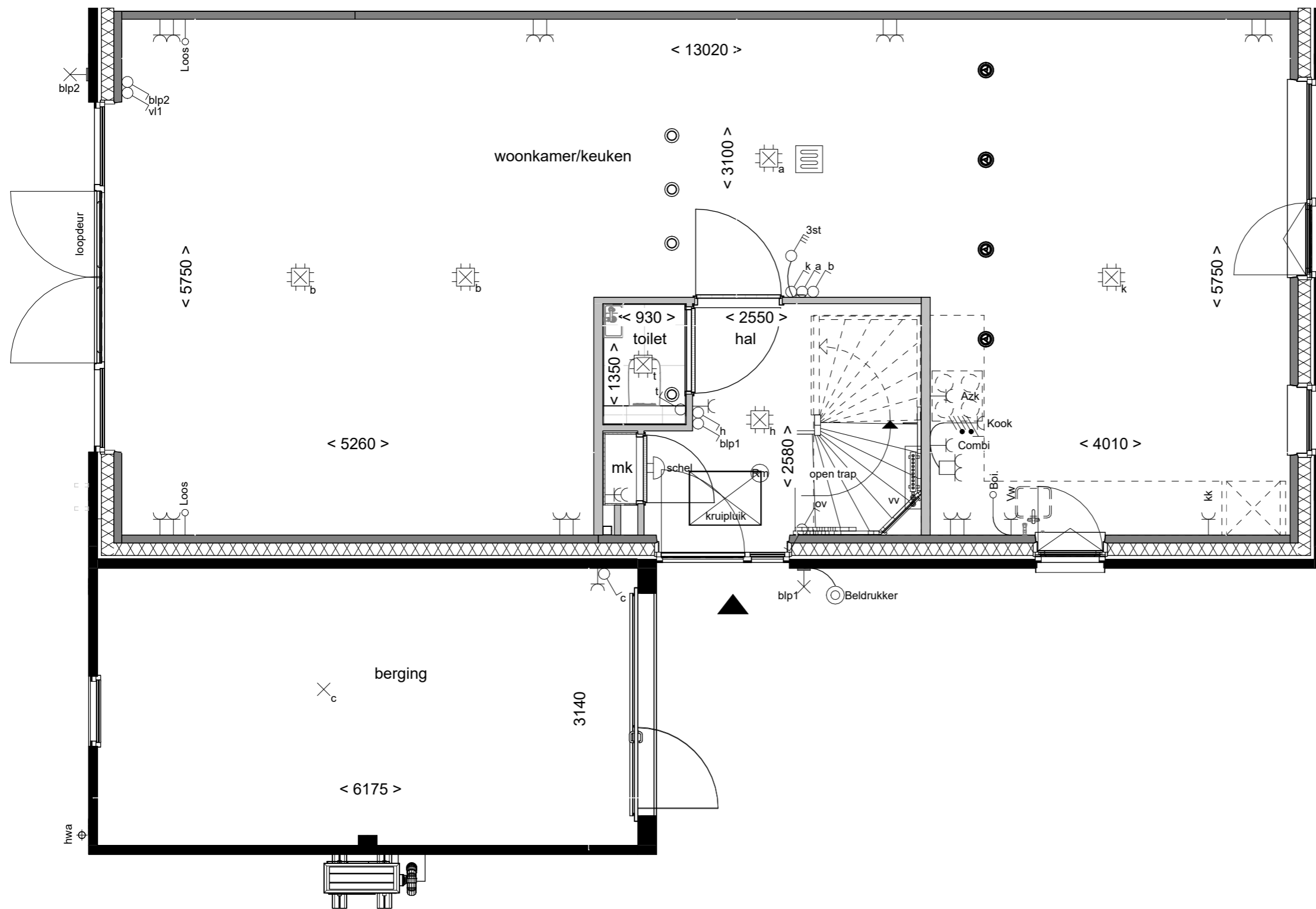

Tekening: **Tuingericht wonen**
 Woningtype: **E60**
 Bouwnummer: **-**
 Optienummer: **1.C.E.12**
 Bladformaat: **A3**
 Schaal: **1:50**
 Datum: **21-04-2026**

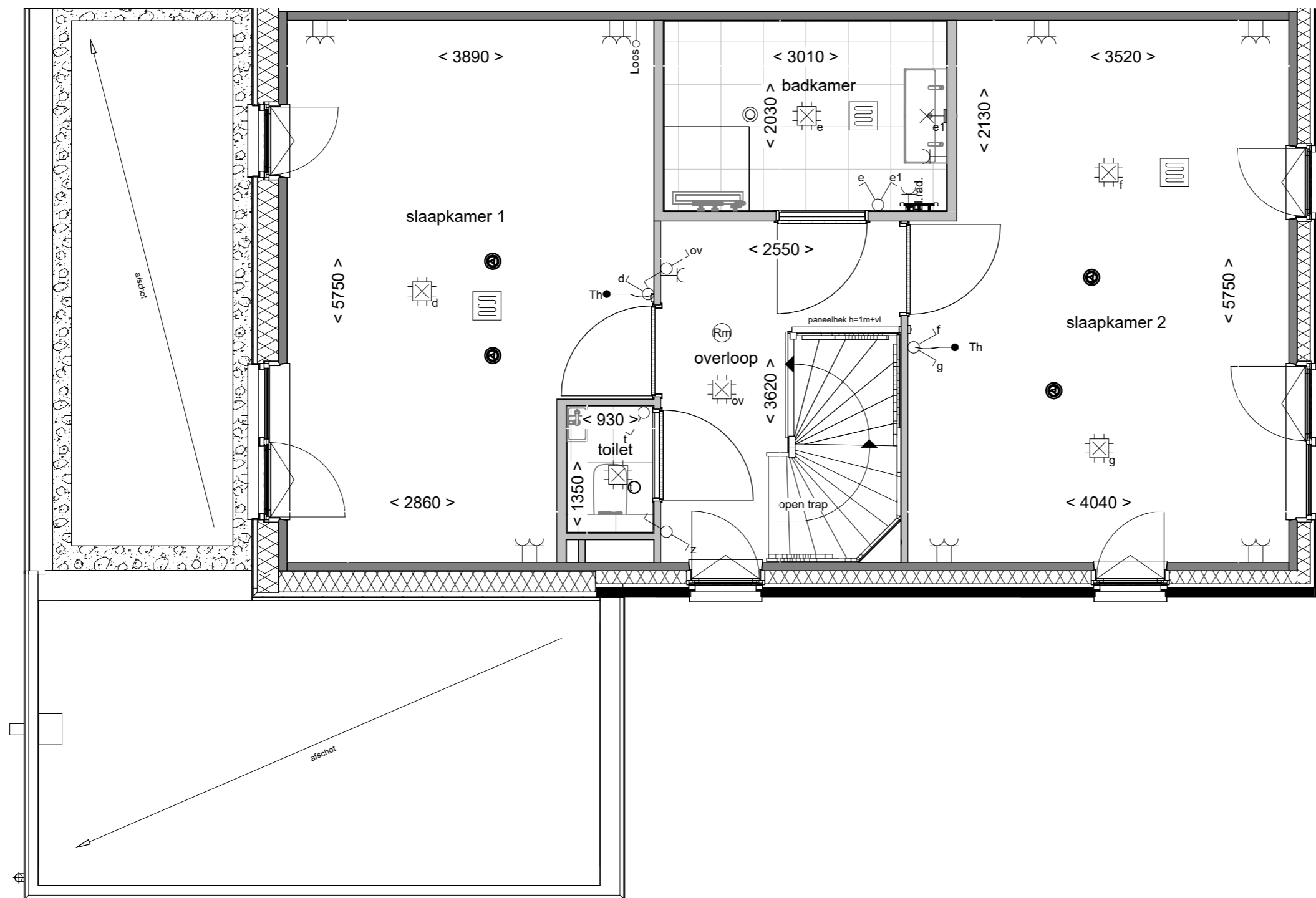

Samenvoegen
slaapkamers voor

Tekening: _____

Woningtype: E60

Bouwnummer: -

Optienummer: 1.C.E.30

Bladformaat: A3

Schaal: 1:50

Datum: 21-04-2026

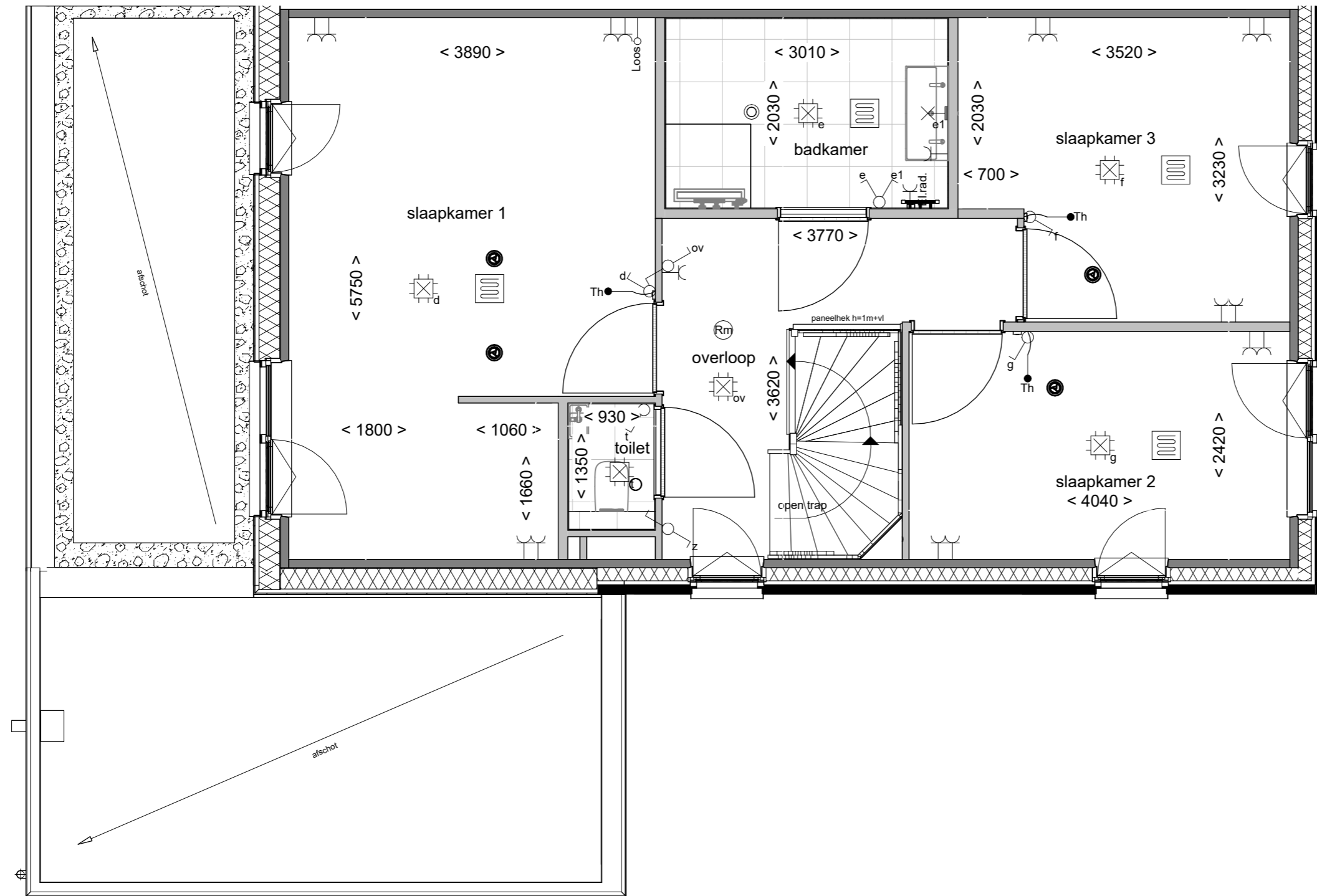

Inloopkast in slaapkamer achter

Tekening:

Woningtype: E60

Bouwnummer: -

Optienummer: 1.C.E.32

Bladformaat: A3

Schaal: 1:50

Datum: 21-04-2026

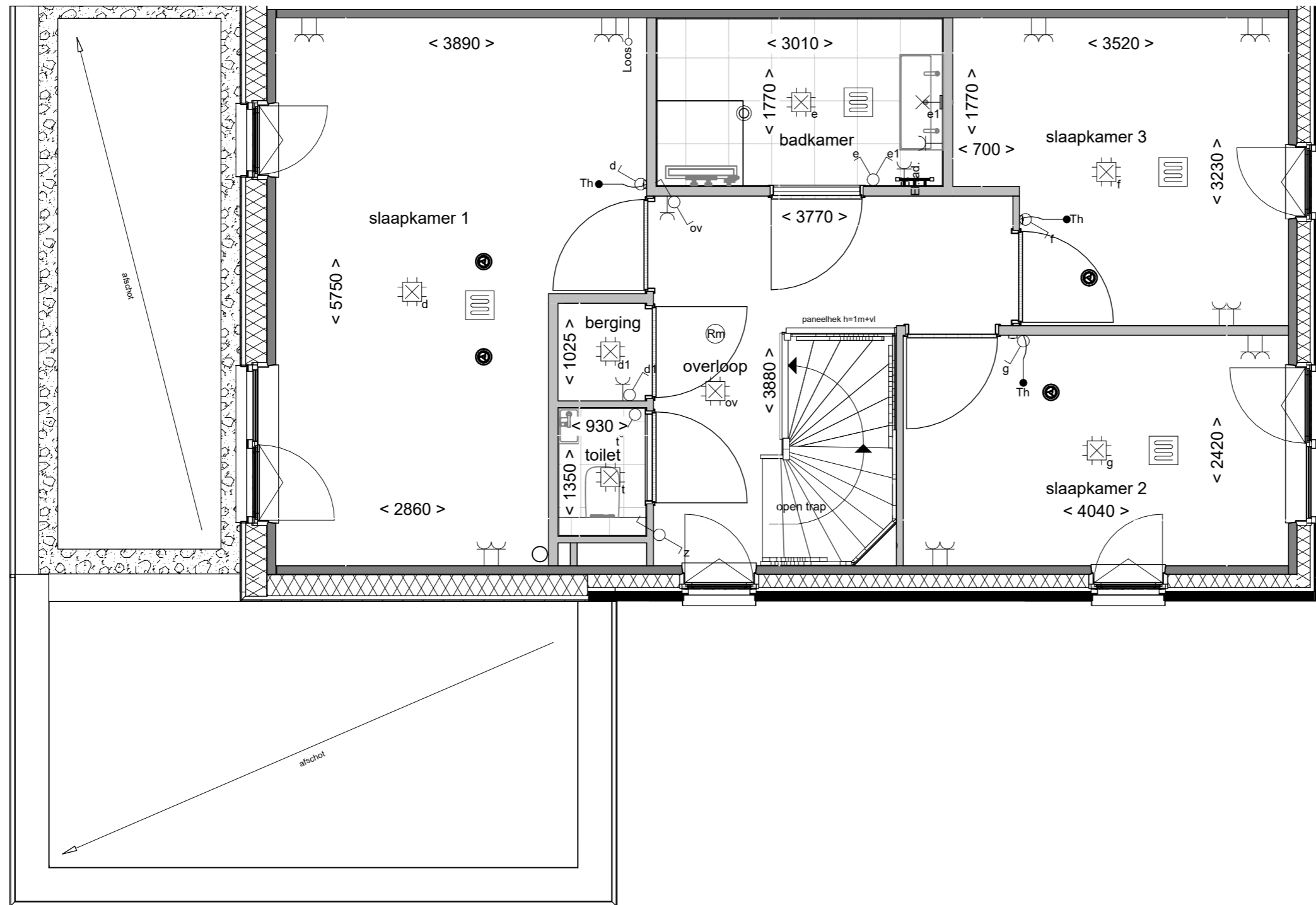

Vaste kast en compacte badk.

Tekening: _____

Woningtype: E60 _____

Bouwnummer: - _____

Optienummer: 1.C.E.34 _____

Bladformaat: A3 _____

Schaal: 1:50 _____

Datum: 21-04-2026 _____

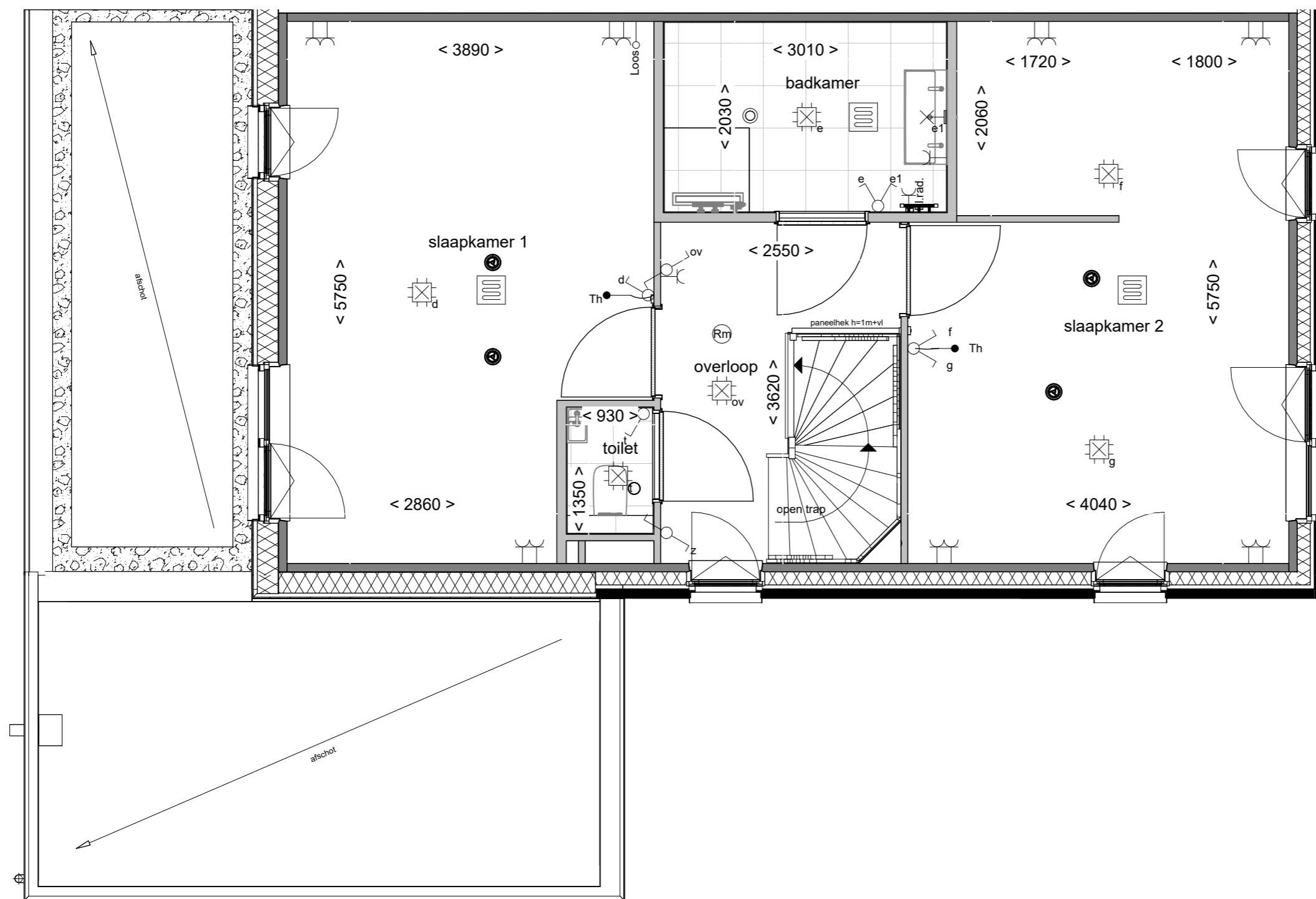

Samenvoegen slpk
voor met inloopkast

Tekening:

Woningtype: E60

Bouwnummer: -

Optienummer: 1.C.E.36

Bladformaat: A3

Schaal: 1:50

Datum: 21-04-2026

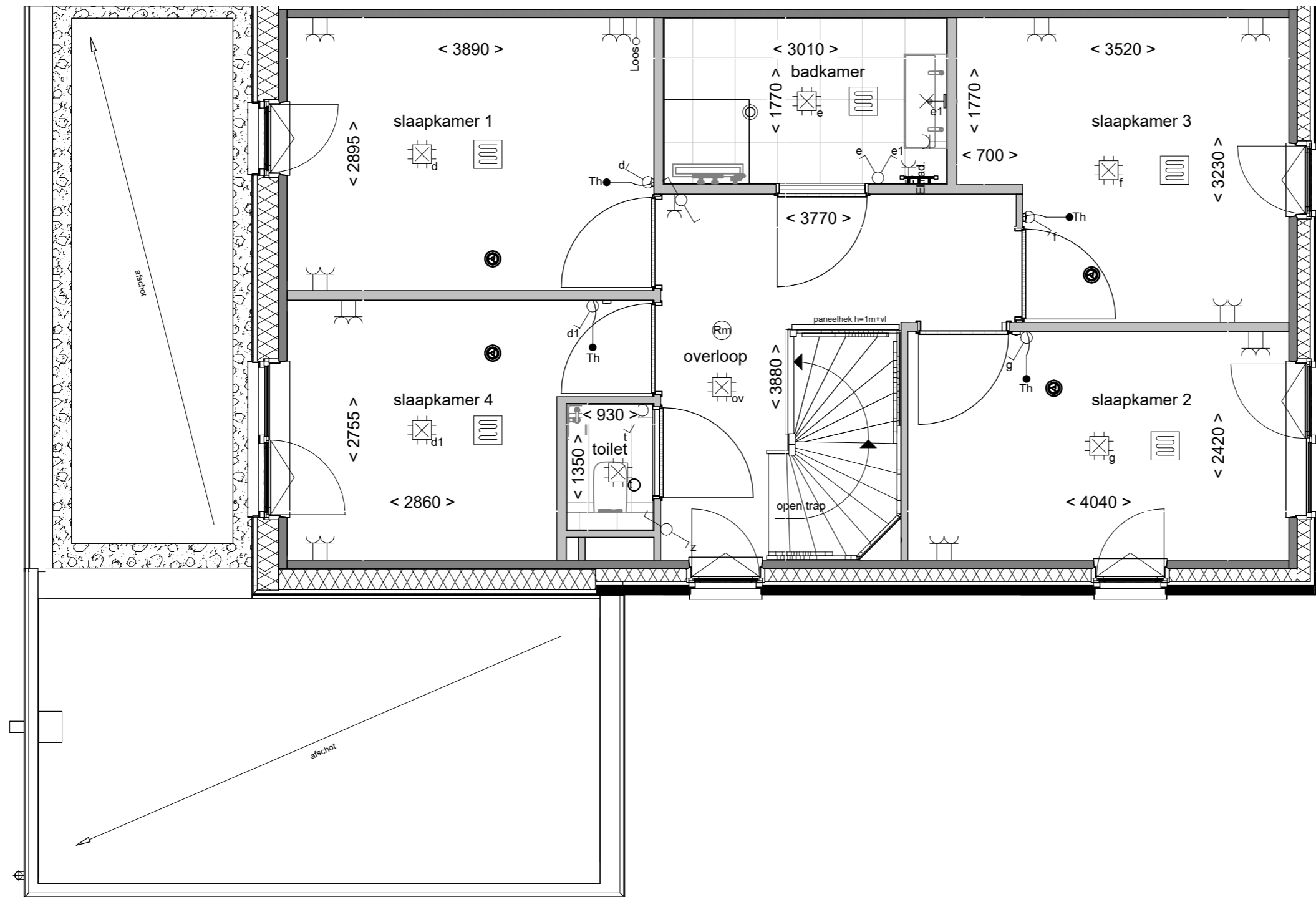

Compacte badk. met
4 slaapkamers

Tekening:

Woningtype: E60

Bouwnummer: -

Optienummer: 1.C.E.38

Bladformaat: A3

Schaal: 1:50

Datum: 21-04-2026

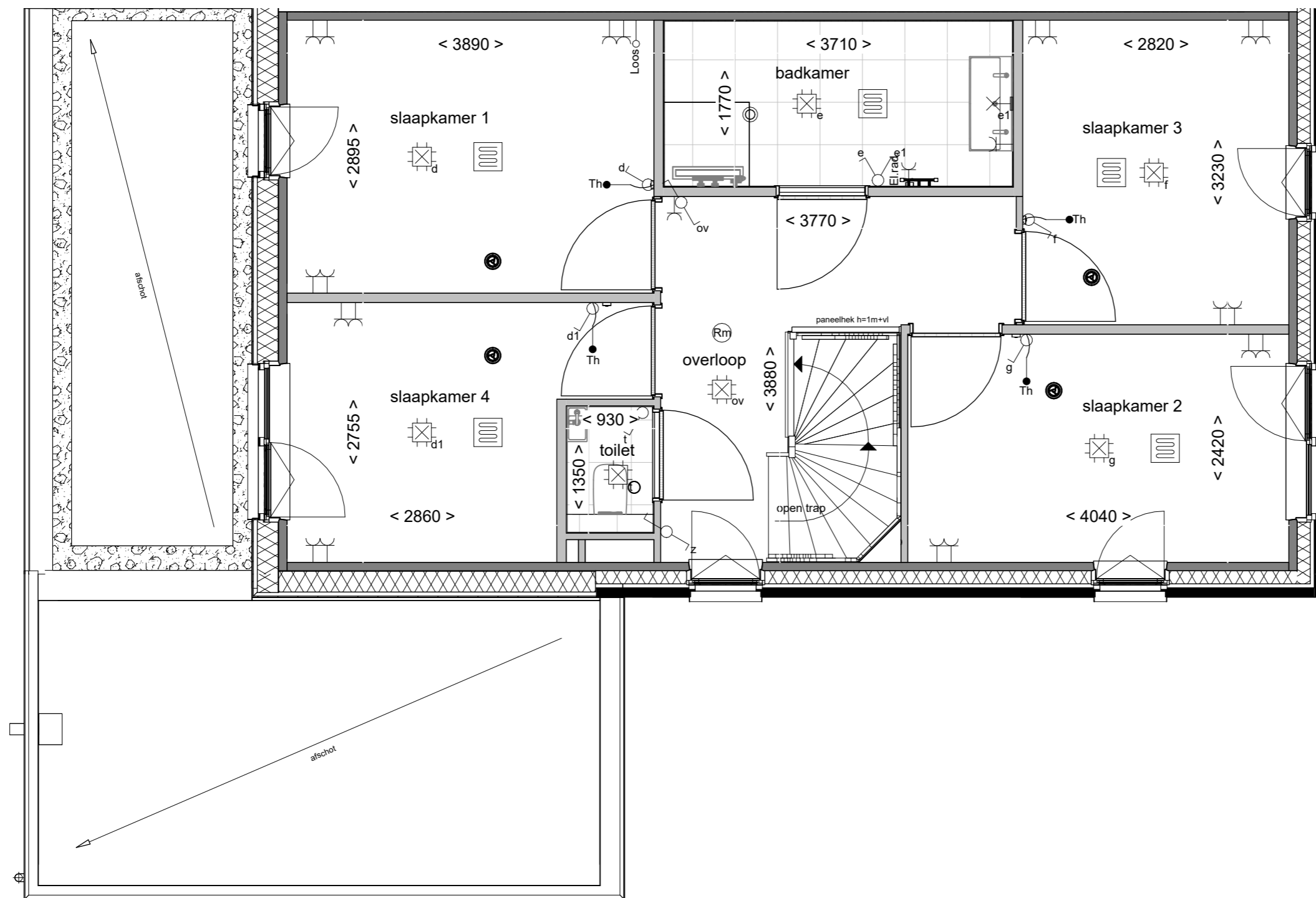

Verl. compacte badk.
met 4 slpk

Tekening: _____

Woningtype: E60 _____

Bouwnummer: - _____

Optienummer: 1.C.E.40 _____

Bladformaat: A3 _____

Schaal: 1:50 _____

Datum: 21-04-2026 _____

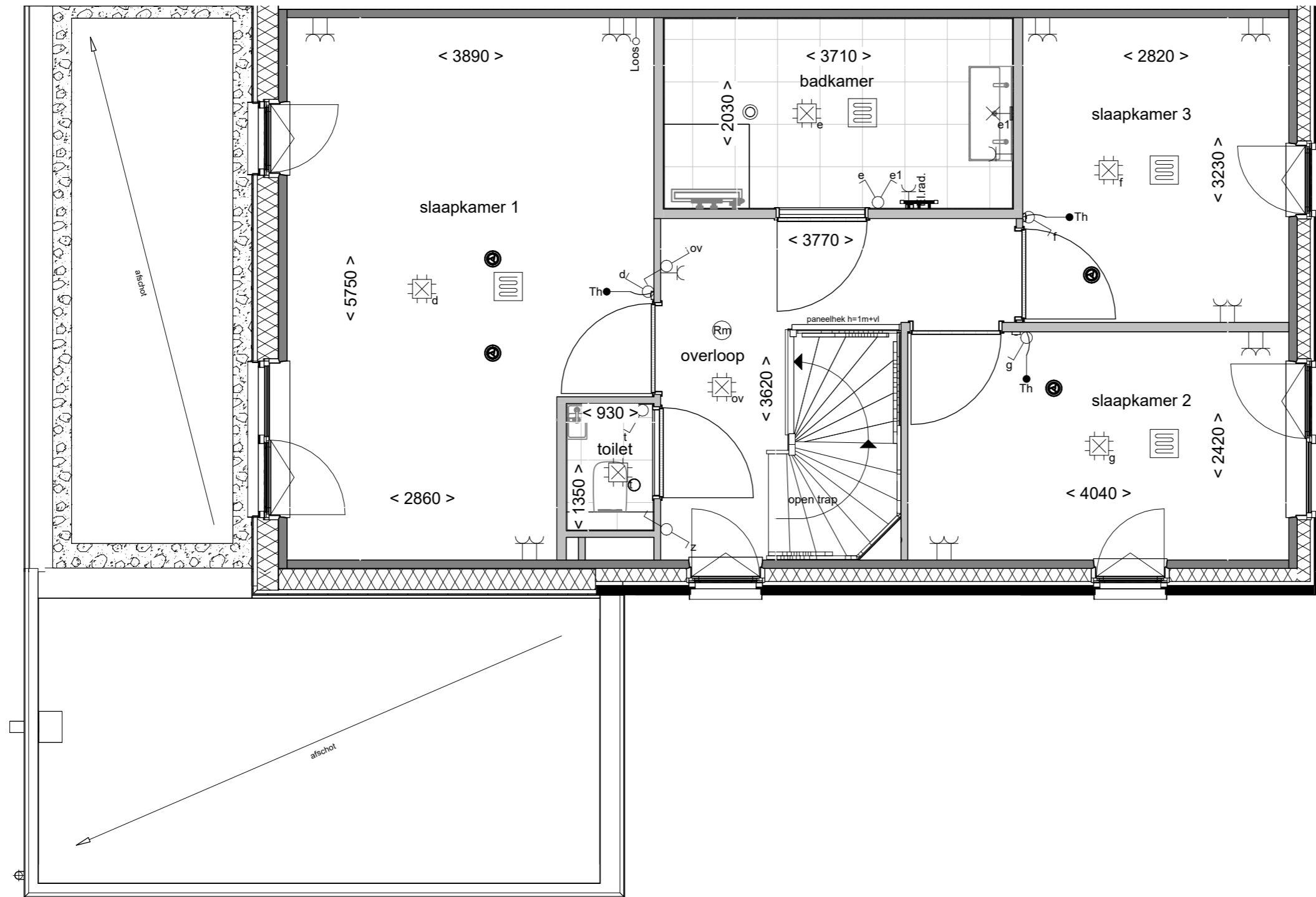

Tekening: **Badkamer vergroten**

Woningtype: **E60**

Bouwnummer: **-**

Optienummer: **1.C.E.42**

Bladformaat: **A3**

Schaal: **1:50**

Datum: **21-04-2026**

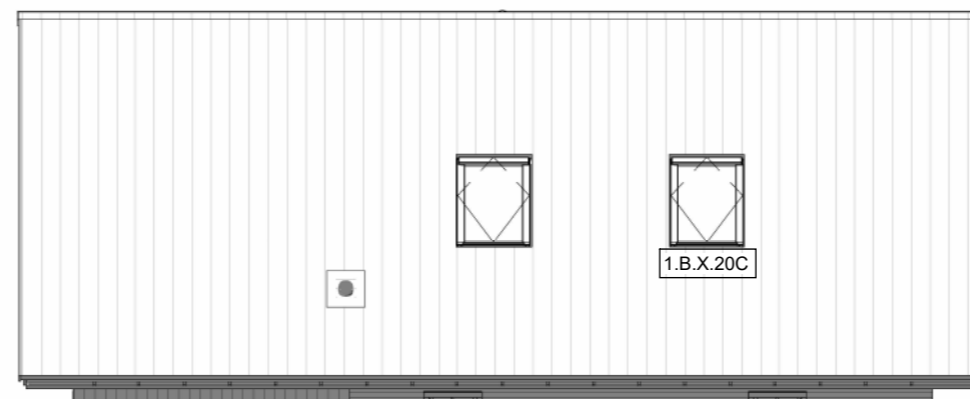
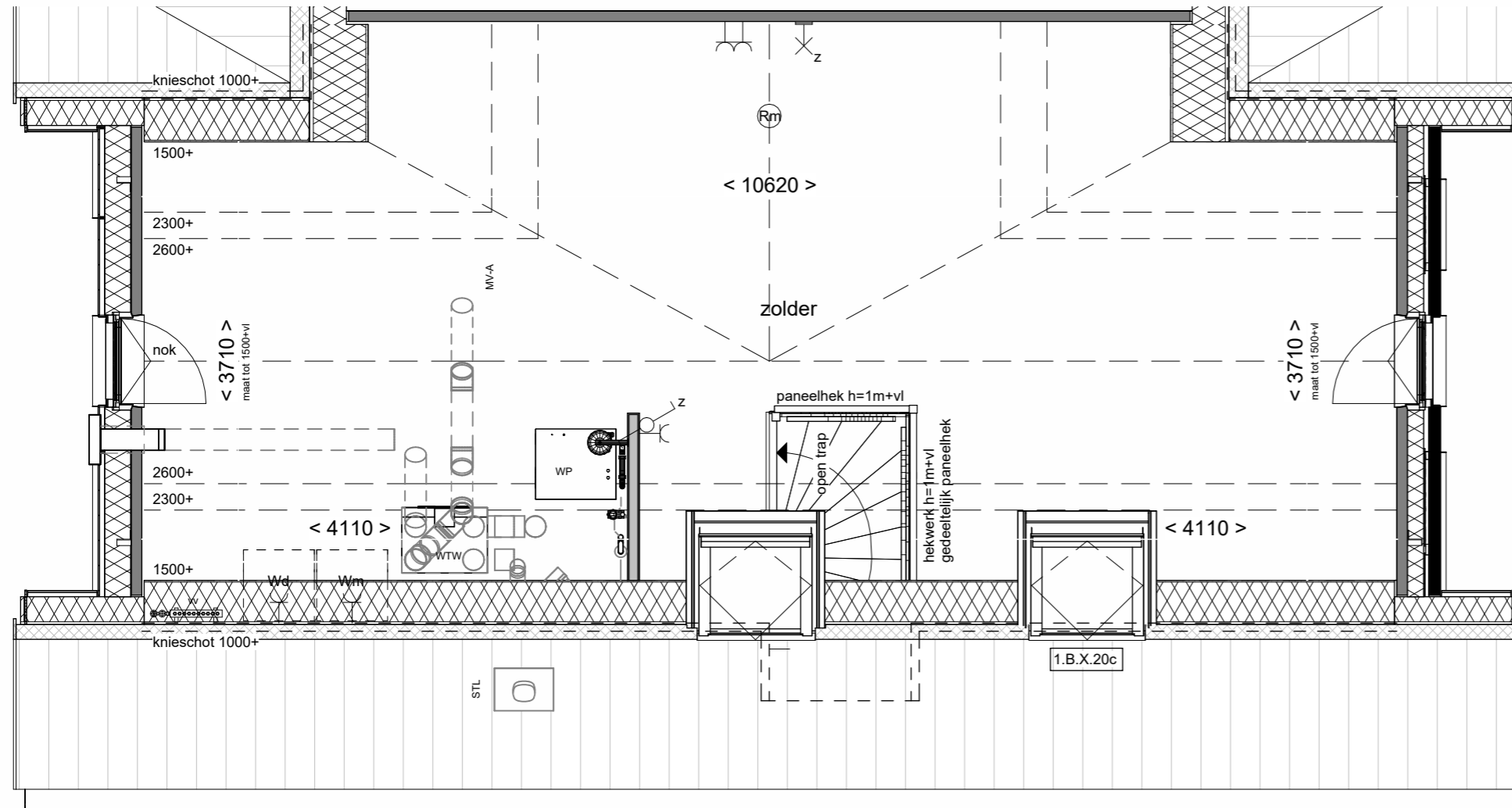

Linkerzijgevel schaal 1:100



Doorsnede schaal 1:100



Tekening:	Dakraam zijgevel
Woningtype:	E60-D
Bouwnummer:	-
Optienummer:	1.B.X.20
Bladformaat:	A3
Schaal:	1:50 / 1:100
Datum:	21-04-2026

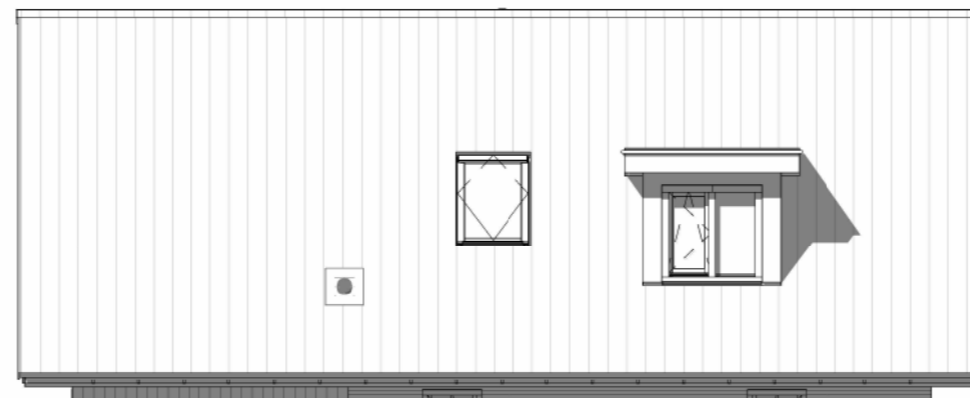
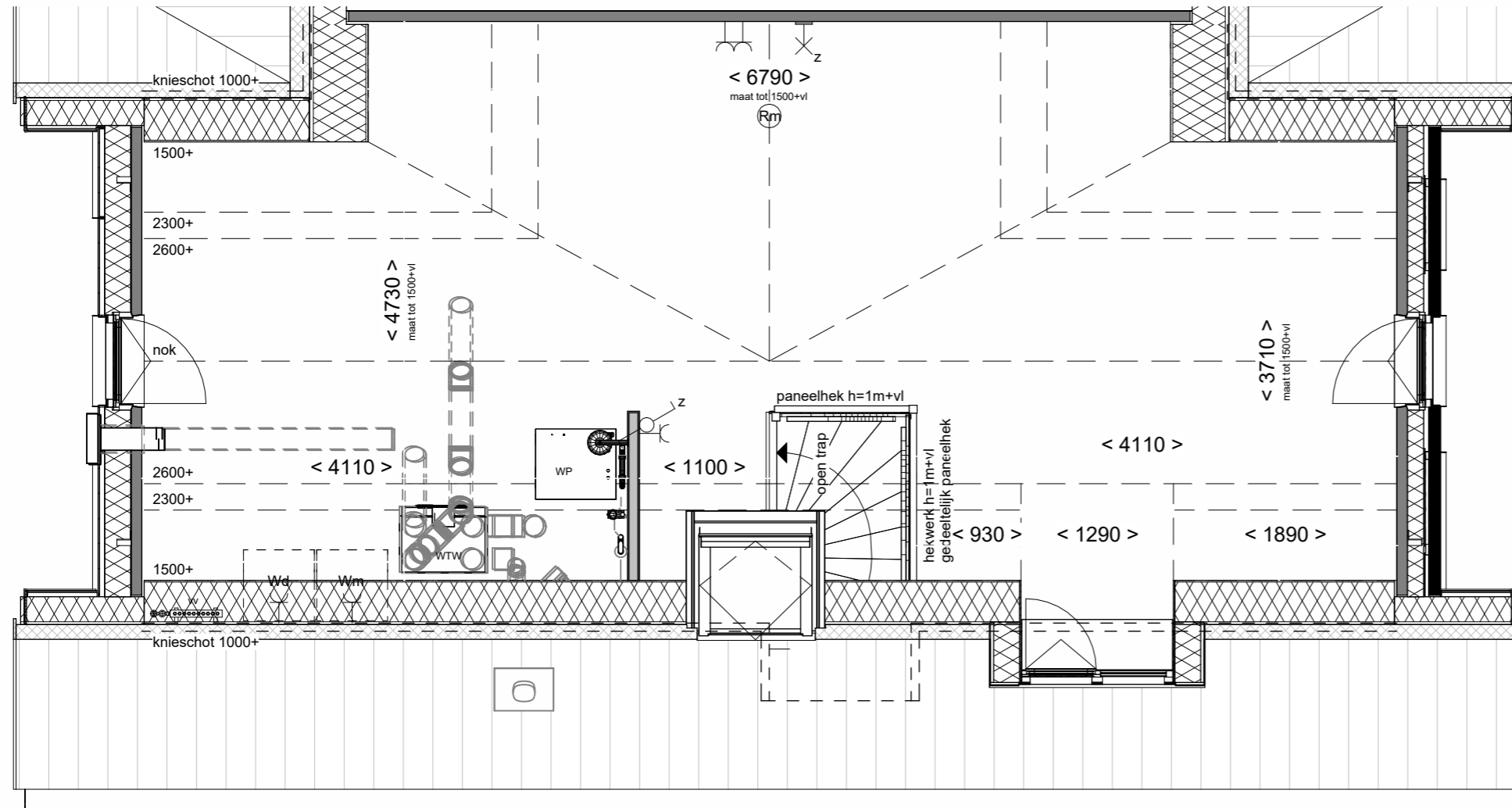

Linkerzijgevel schaal 1:100

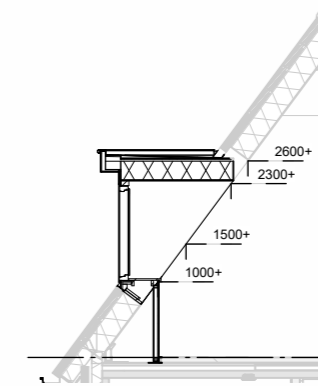

Doorsnede schaal 1:100



**Wonen aan
de Gantel**

Dakkapel zijgevel
130cm

Tekening: 130cm

Woningtype: E60-D

Bouwnummer: -

Optienummer: 1.B.X.20

Bladformaat: A3

Schaal: 1:50 / 1:100

Datum: 21-04-2026

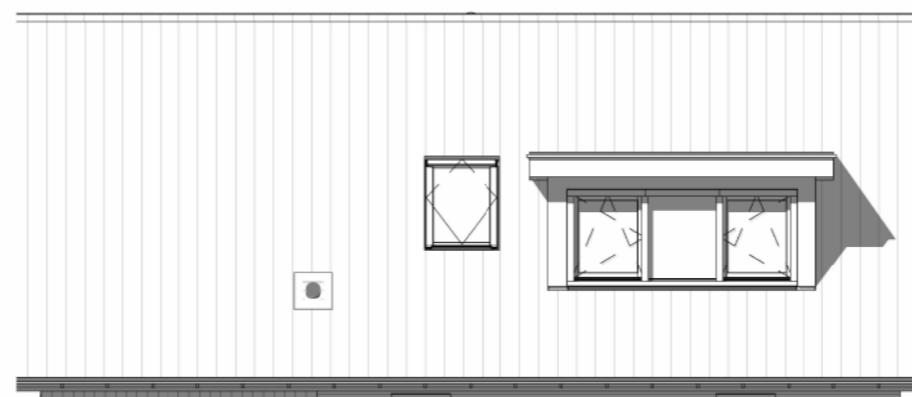
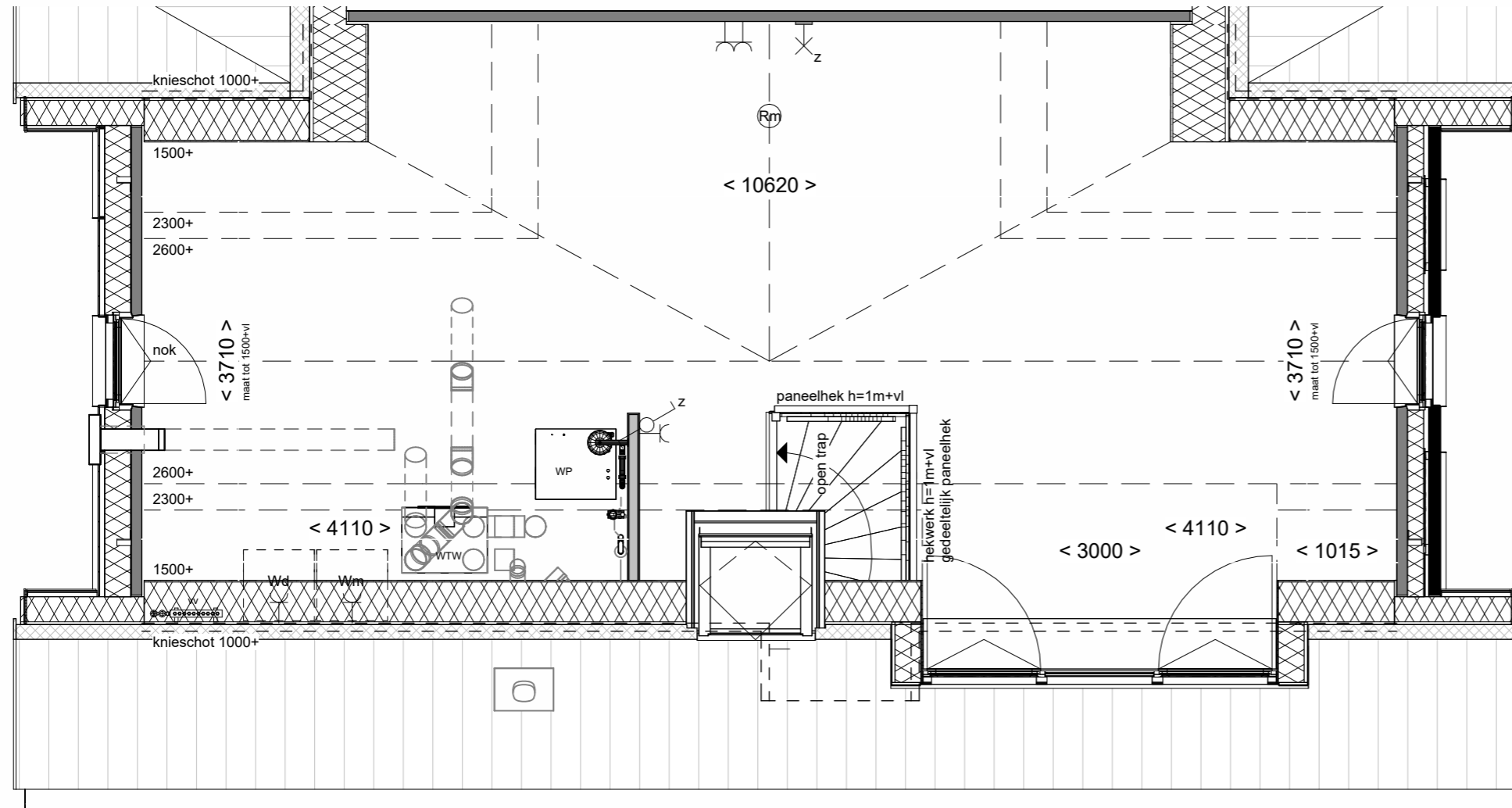

Linkerzijgevel schaal 1:100

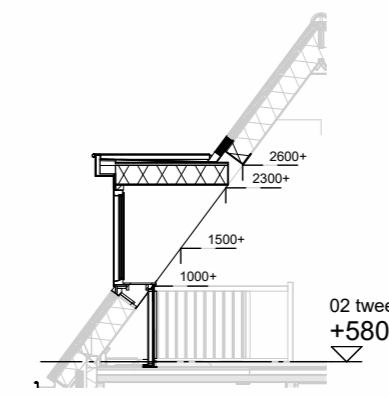

Doorsnede schaal 1:100



Dakkapel zijgevel
300cm

Tekening: 300cm

Woningtype: E60-D

Bouwnummer: -

Optienummer: 1.B.X.38

Bladformaat: A3

Schaal: 1:50 / 1:100

Datum: 21-04-2026

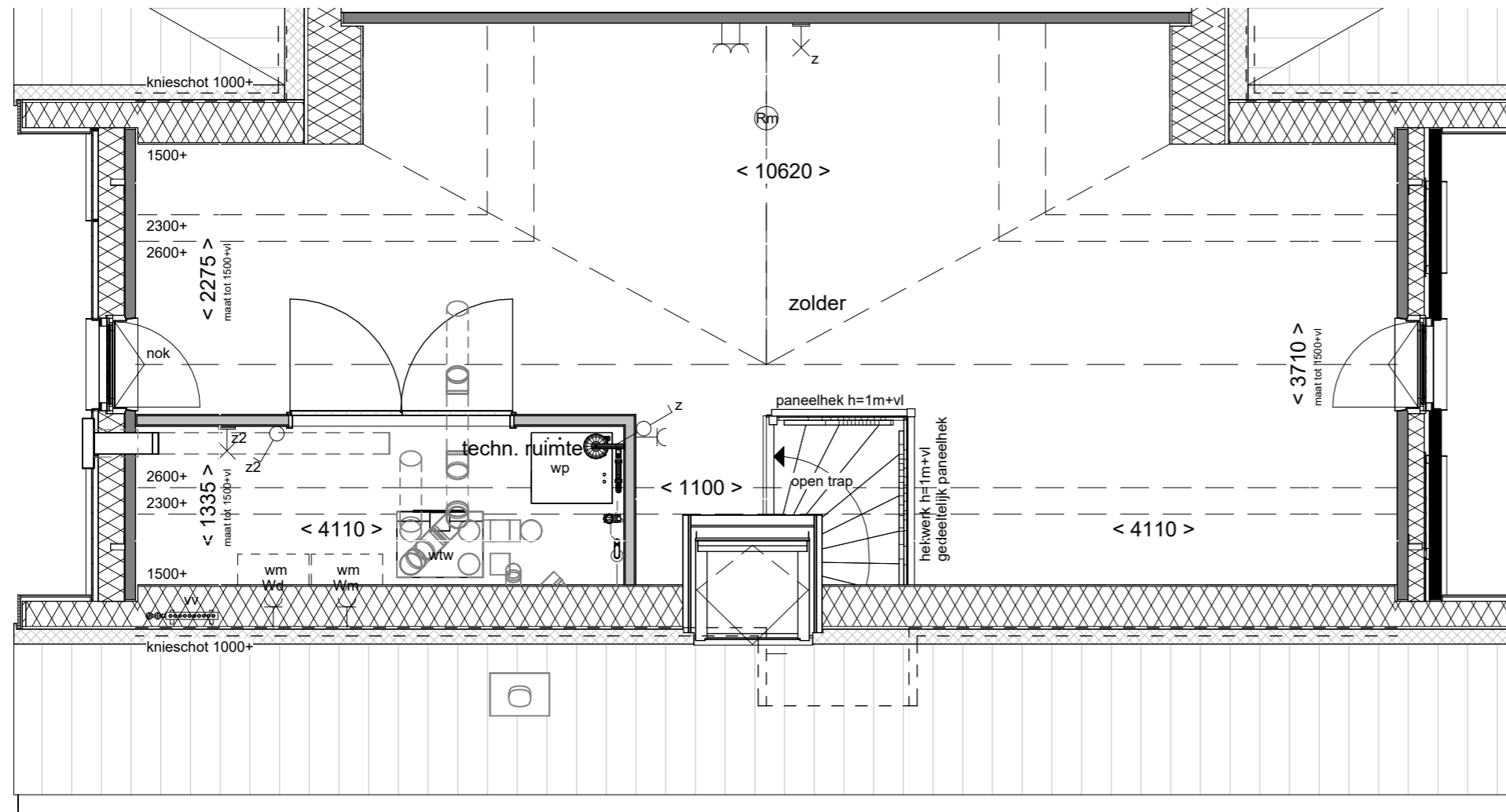

**Indeling met
techniekkast**

Tekening:

Woningtype: E57-D

Bouwnummer: -

Optienummer: 1.C.E.70

Bladformaat: A3

Schaal: 1:50

Datum: 21-04-2026

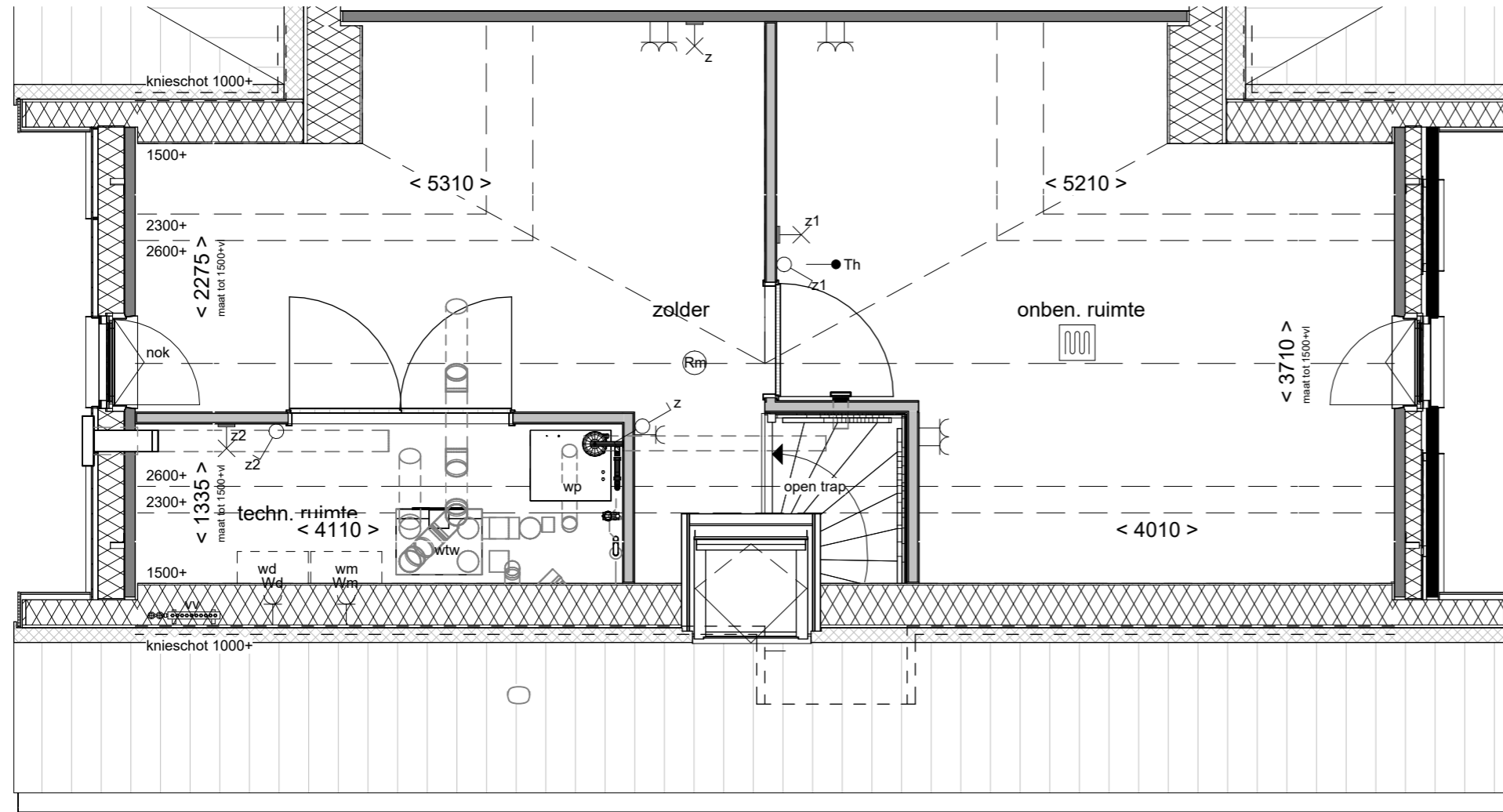

**Indeling met 1
onben. ruimte**

Tekening: **onben. ruimte**

Woningtype: **E60-D**

Bouwnummer: **-**

Optienummer: **1.C.E.72**

Bladformaat: **A3**

Schaal: **1:50**

Datum: **21-04-2026**

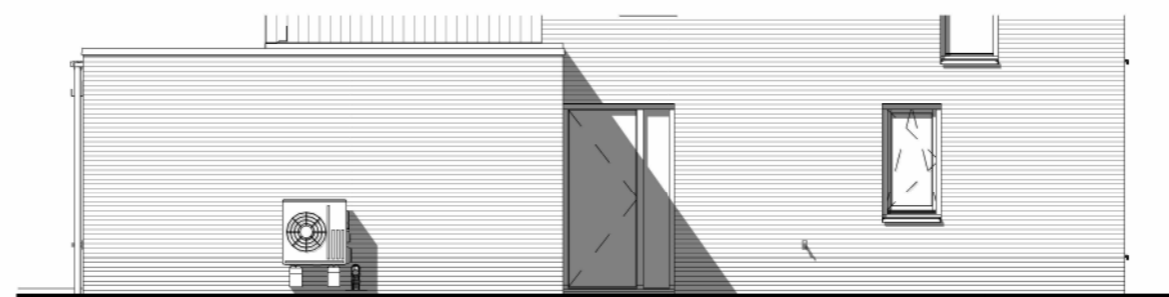
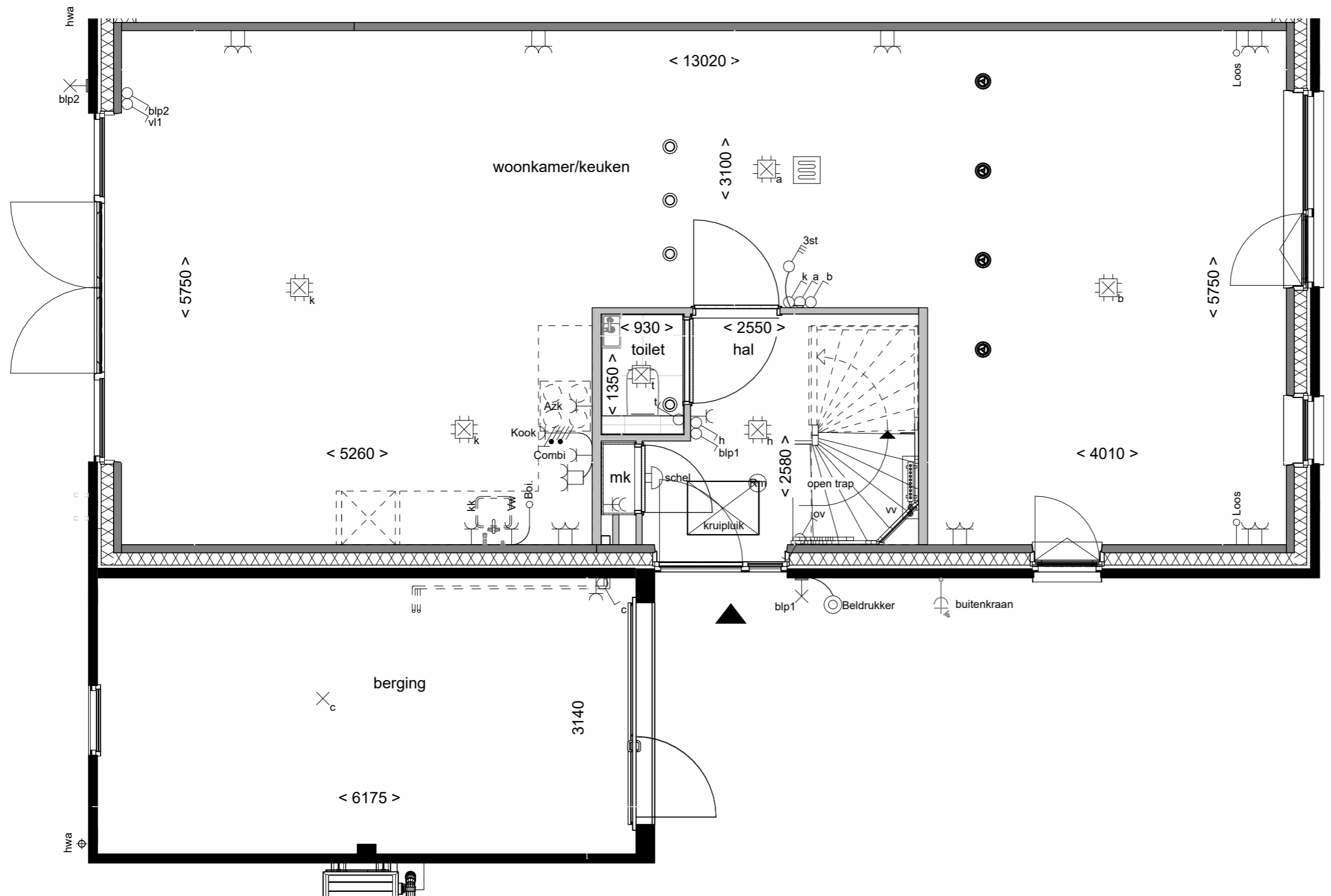

Linkerzijgevel schaal 1:100



vorstvrij buitenkraan
naast voordeur

Tekening:	
Woningtype:	E60
Bouwnummer:	02-07,10-13,16,17
Optienummer:	2.K.0.40
Bladformaat:	A3
Schaal:	1:50 / 1:100
Datum:	21-04-2026

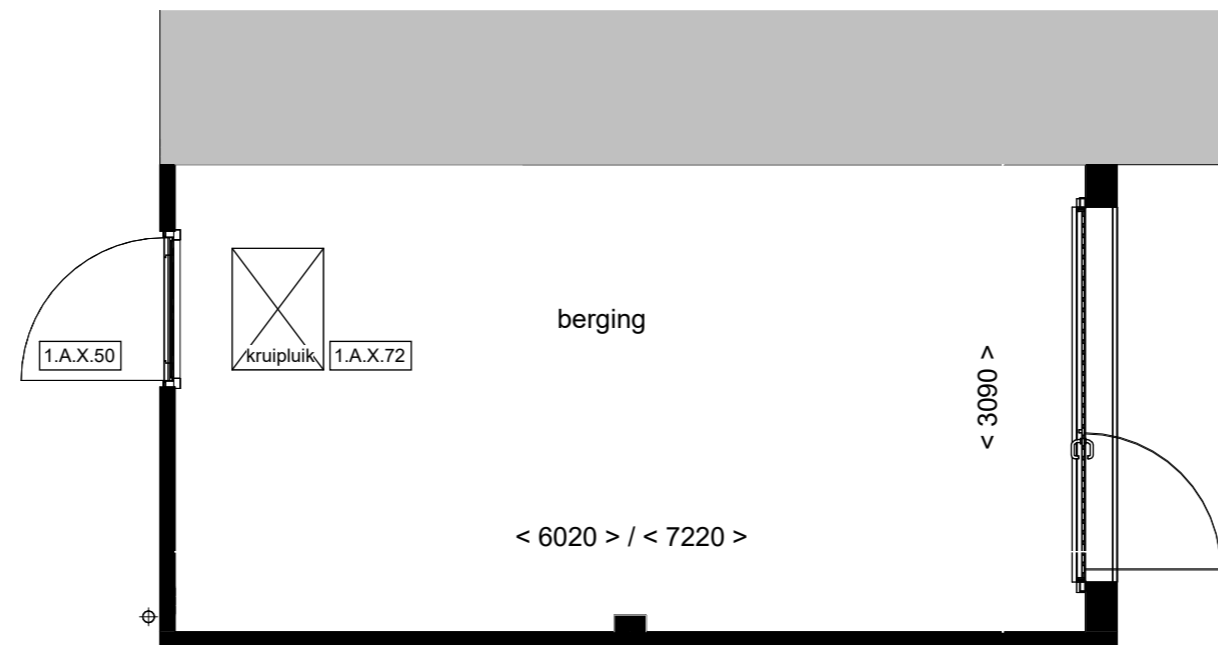

**Wonen aan
de Gantel**

**Kruipluik in de
berging**

Tekening:

Woningtype: E60/F60/F60+/F60D

Bouwnummer: 1 t/m 20

Optienummer: 1.A.X.50 / 1.A.X.72

Bladformaat: A3

Schaal: 1 : 50

Datum: 21-04-2026

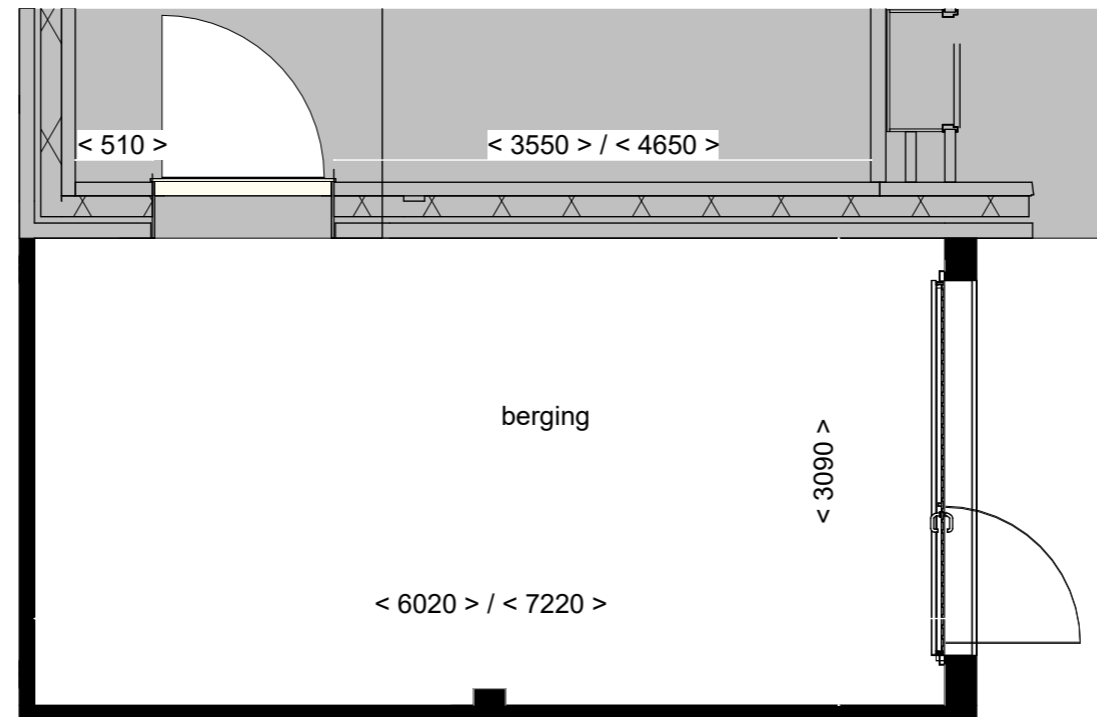

Tekening: Buitendeur tussen woning en berging

Woningtype: E60/F60/F60+

Bouwnummer: 1 t/m 19

Optienummer: 1.A.X.74 B

Bladformaat: A3

Schaal: 1 : 50

Datum: 21-04-2026

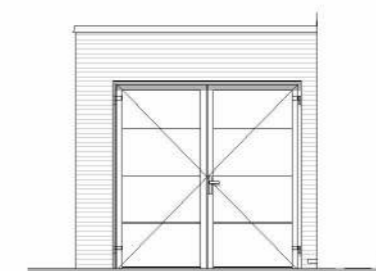
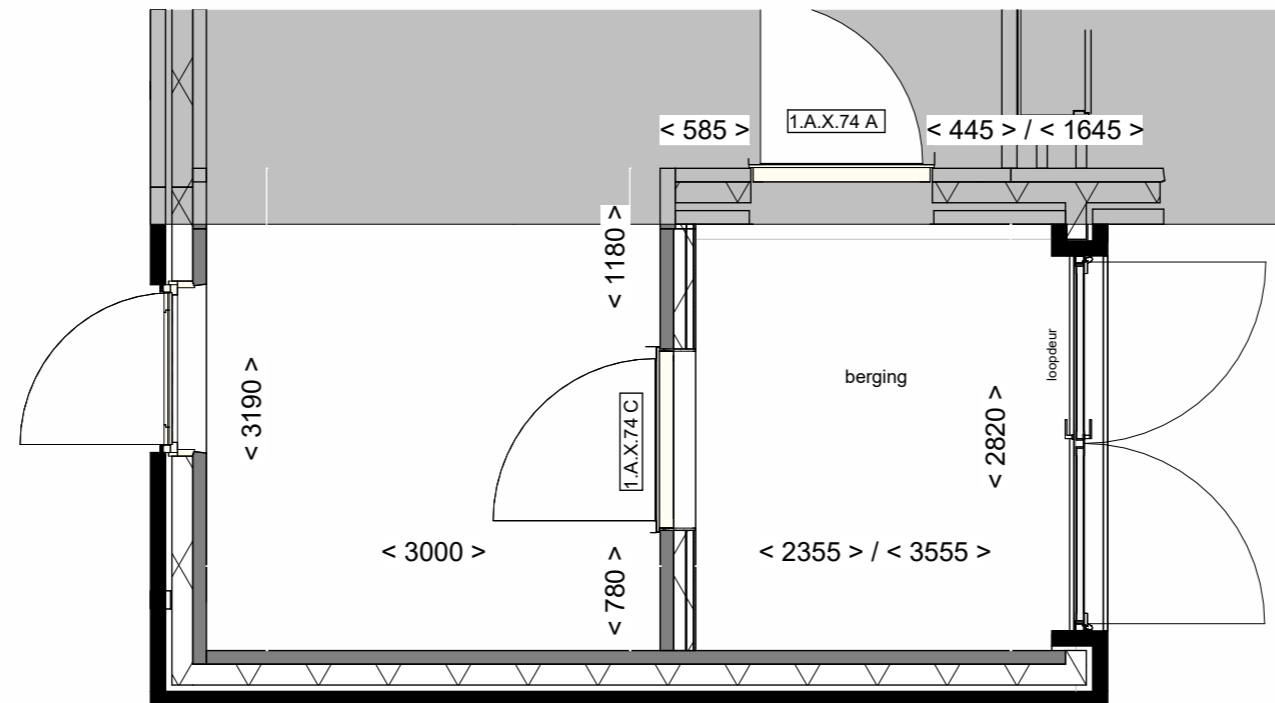

Voorgevel schaal 1:100



Buitendeur tussen
woning en berging

Tekening:

Woningtype: E60/F60/F60+

Bouwnummer: 1 t/m 19

Optienummer: 1.A.X.74 C

Bladformaat: A3

Schaal: 1:50

Datum: 21-04-2026

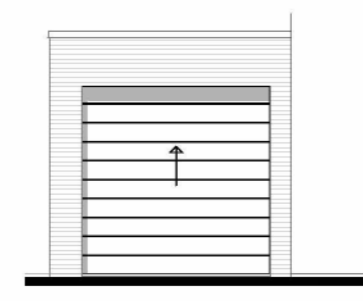
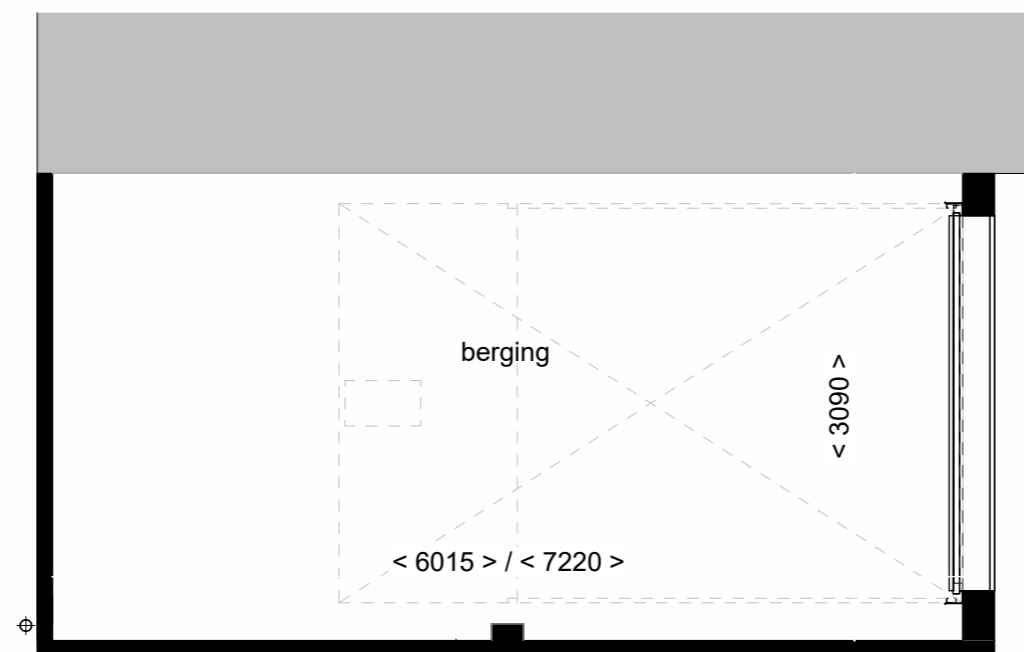

Voorgevel schaal 1:100



**Wonen aan
de Gantel**

Sectionaaldeur ipv
kanteldeur

Tekening:

Woningtype: E60/F60/F60+/F60D

Bouwnummer: 1 t/m 20

Optienummer: 1.A.X.80

Bladformaat: A3

Schaal: 1:50

Datum: 21-04-2026

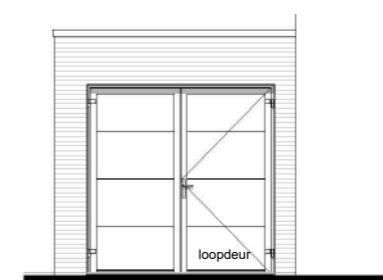
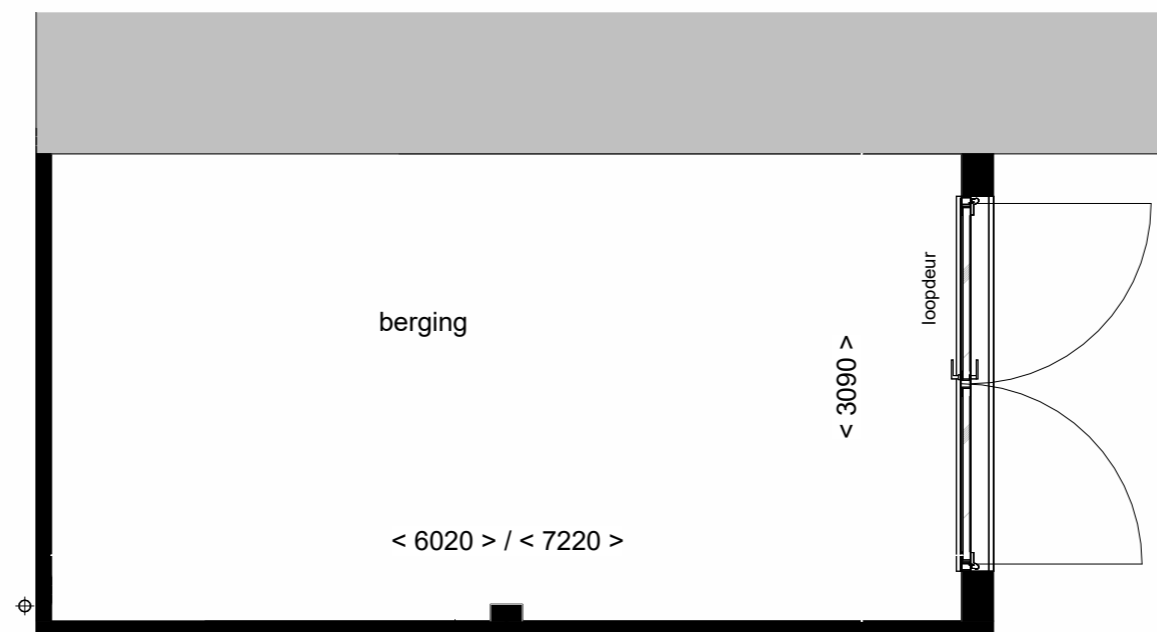

Voorgevel schaal 1:100



**Wonen aan
de Gantel**

Dubbele

Tekening: openslaande deuren

Woningtype: E60/F60/F60+/F60D

Bouwnummer: 1 t/m 20

Optienummer: 1.A.X.84

Bladformaat: A3

Schaal: 1:50

Datum: 21-04-2026

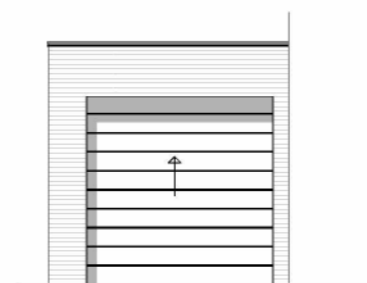
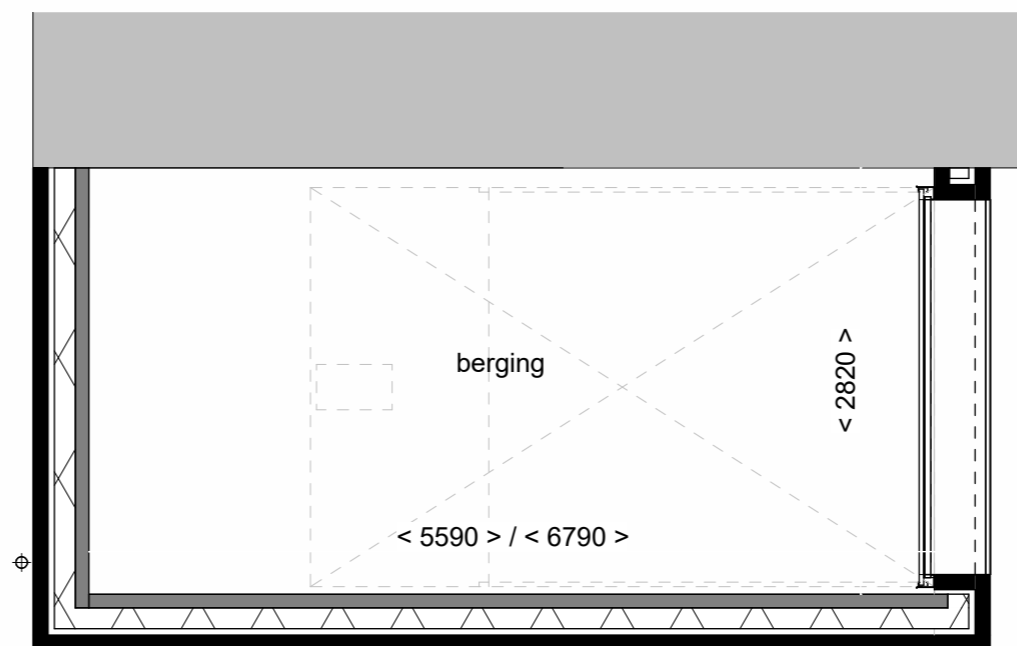

Voorgevel schaal 1:100



Achtergevel schaal 1:100



**Wonen aan
de Gantel**

Tekening: **Isoleren berging**

Woningtype: **E60/F60/F60+/F60D**

Bouwnummer: **01 t/m 20**

Optienummer: **1.A.X.86**

Bladformaat: **A3**

Schaal: **1:50**

Datum: **21-04-2026**

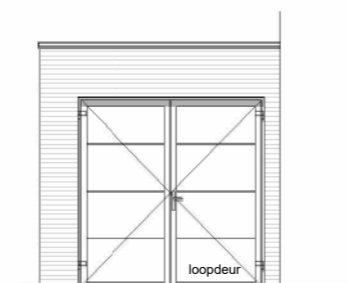
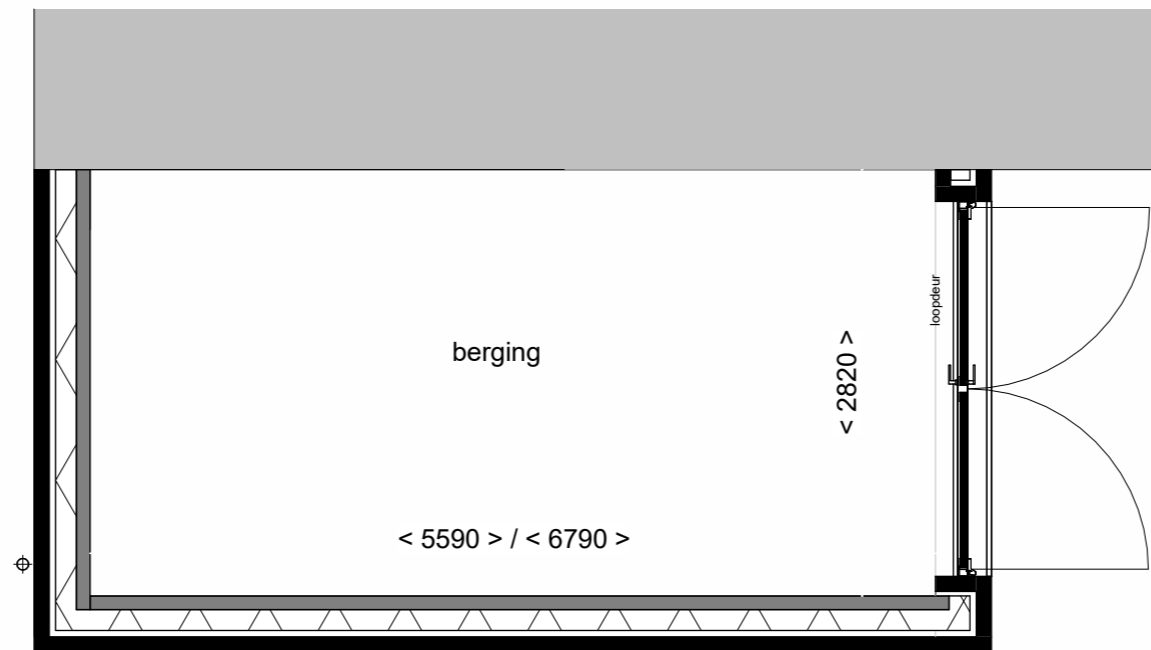

Voorgevel schaal 1:100



Achtergevel schaal 1:100



**Wonen aan
de Gantel**

Dubbele deuren,
isoleren

Tekening:

Woningtype: E60/F60/F60+/F60D

Bouwnummer: 1 t/m 20

Optienummer: 1.A.X.94

Bladformaat: A3

Schaal: 1:50

Datum: 21-04-2026